

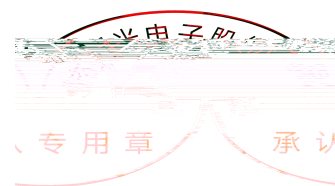

SPECIFICATION

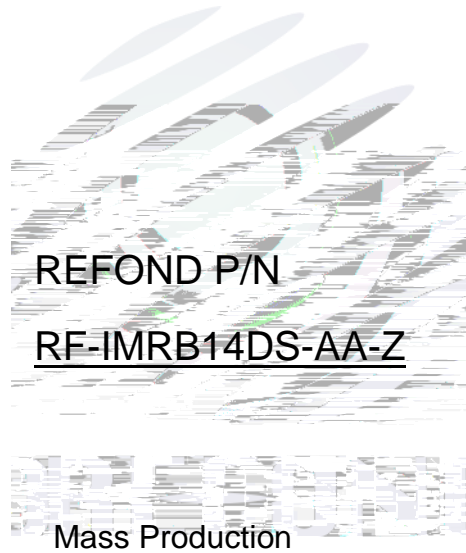



Contents

- 1. Description
 - 1.1 General Description
 - 1.2 Features
 - 1.3 Applient(tu)-5im





1.4 Package Dimension 封装尺寸

Fig.1-1 Top View

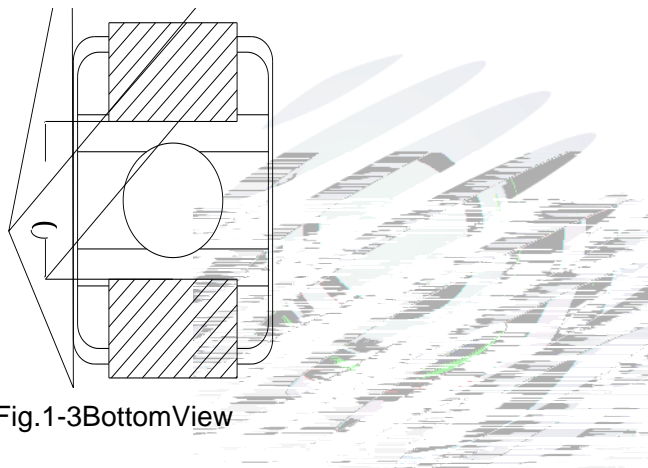

Fig.1-3BottomView

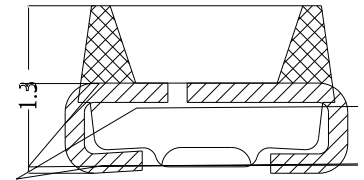

Fig.1-2SideView

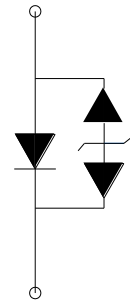

Fig.1-4Polarity

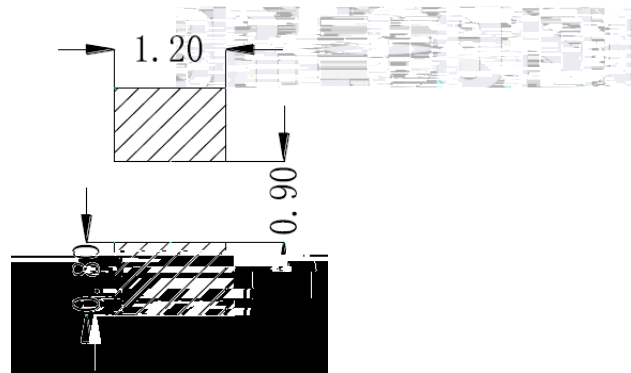
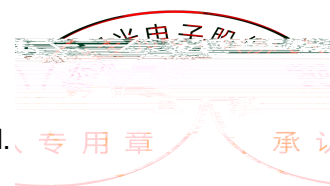

Fig.1-5Soldering Patterns

Notes

- 1. All dimensions units are millimeters.
- 2. All dimensions tolerances are $\pm 0.2\text{mm}$ unless otherwise noted.



0.2



1.5 Product Parameters

Table 1-1 Electrical / Optical Characteristics at Ts=25°C

Item	Symbol	Test Condition	Value			Unit
			Min.	Typ.	Max.	
Forward Voltage	V_F	$I_F=20mA$	2.7	---	3.3	V
Reverse Current	I_R	$V_R=5V$	Not designed for reverse operation			
Luminous Intensity	I_V	$I_F=20mA$	1650	---	2300	mcd
Viewing Angle		$I_F=20mA$	---	120	---	deg
Thermal Resistance.	R_{THJ-S}	$I_F=20mA$	---	300	---	/W

Table 1-2 Absolute Maximum Ratings at Ts=25°C

Parameter	Symbol	Rating	Units
Power Dissipation	P_D	99	mW
Forward Current	I_F	30	mA
Peak Forward Current	I_{FP}	100	mA

Reverse Voltage



Notes

1. 1/10 Duty cycle, 0.1ms pulse width. 0.1ms, 1/10.
2. The above forward voltage measurement allowance tolerance is $\pm 0.1V$.
3. The above color coordinates measurement allowance tolerance is ± 0.005 . ± 0.005 .
4. The above luminous intensity measurement allowance tolerance $\pm 10\%$.
5. Care is to be taken that power dissipation does not exceed the absolute maximum rating of the product.
6. All measurements were made under the standardized environment of Refond.
7. When the LEDs are in operation the maximum current should be decided after measuring the package temperature, junction temperature should not exceed the maximum rate. LED
8. ESD yield is over 90% at 8000V ESD (HBM). ESD protection during products handing is needed. 90% LED ESD8000V

1.6 Bin Range Of Forward Voltage and Luminous Intensity (IF=20mA) 电压与发光强度分 BIN 范围(IF=20mA)

Table 1-3

V _F V	E1	E2	F1	F2	G1	G2	H1	H2
	2.4-2.5	2.5-2.6	2.6-2.7	2.7-2.8	2.8-2.9	2.9-3.0	3.0-3.1	3.1-3.2
IV mcd	M6	N3	N4					
	1650-1800	1800-2050	2050-2300					

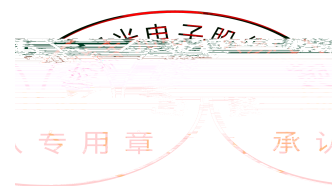

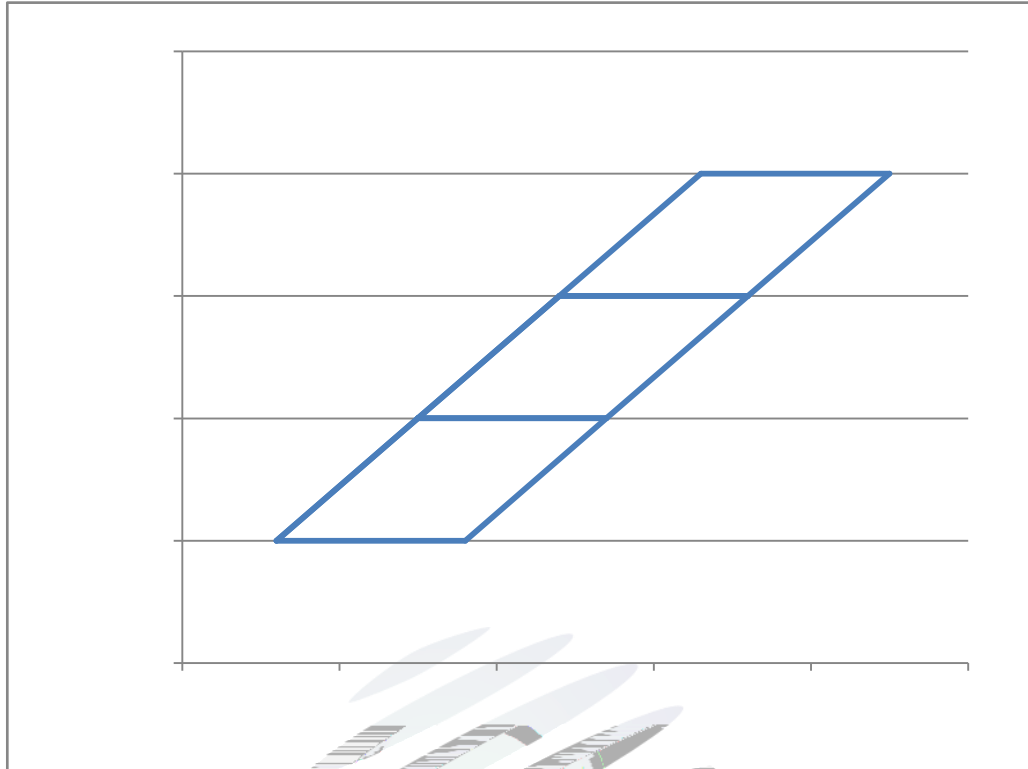
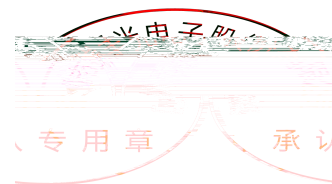

Fig. 1-6 The C.I.E Chromaticity Diagram CIE

Table 1-4

BIN CODE	CIE-X1	CIE-Y1	CIE-X2	CIE-Y2	CIE-X3	CIE-Y3	CIE-X4	CIE-Y4
IA7	0.4310	0.4000	0.4400	0.4100	0.4520	0.4100	0.4430	0.4000
IA8	0.4400	0.4100	0.4490	0.4200	0.4610	0.4200	0.4520	0.4100
IA9	0.4490	0.4200	0.4580	0.4300	0.4700	0.4300	0.4610	0.4200



1.7 Typical Optical Characteristics Curves 典型光学特性曲线

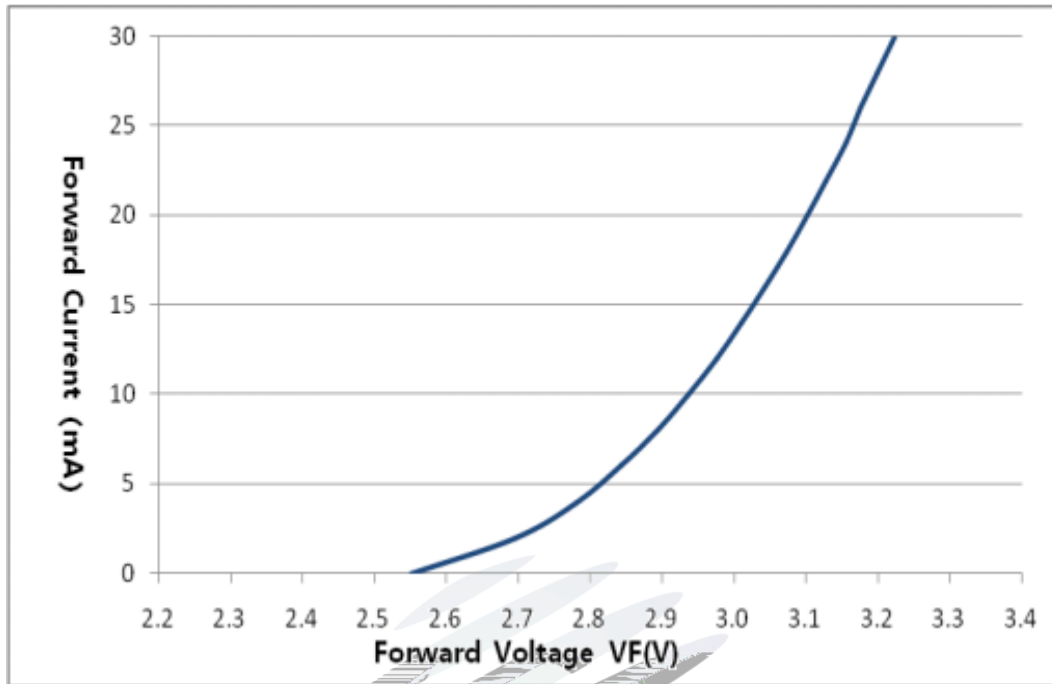

Fig. 1-7 Forward Voltage Vs Forward Current

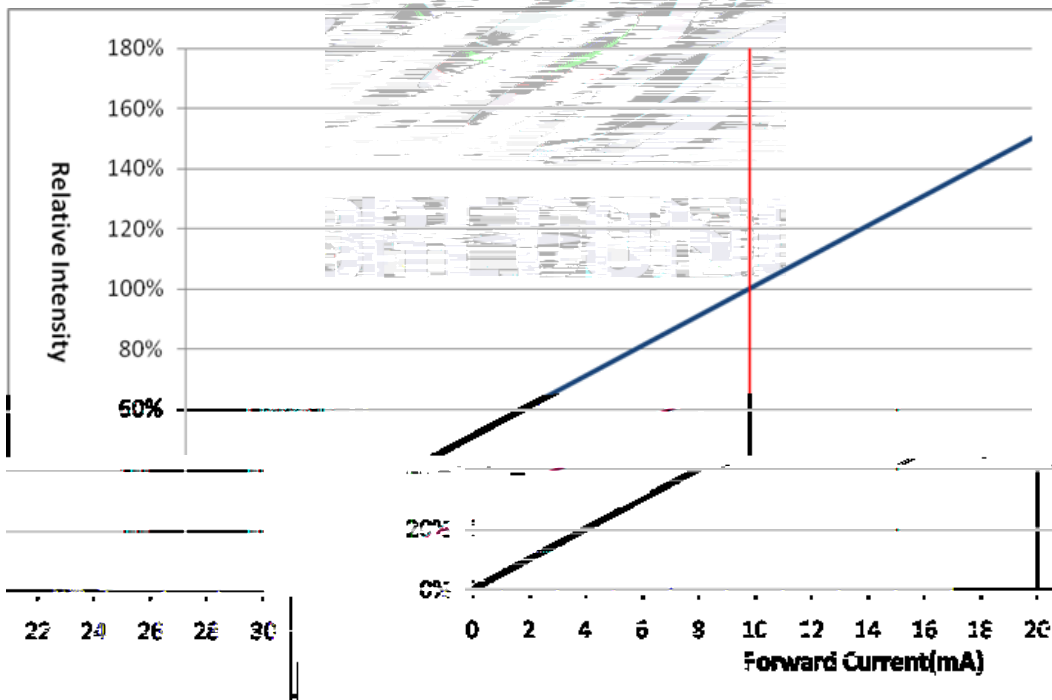
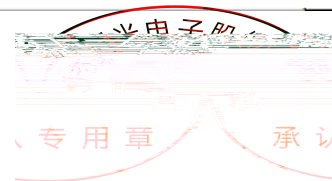

Fig. 1-8 Forward Current Vs Relative Intensity



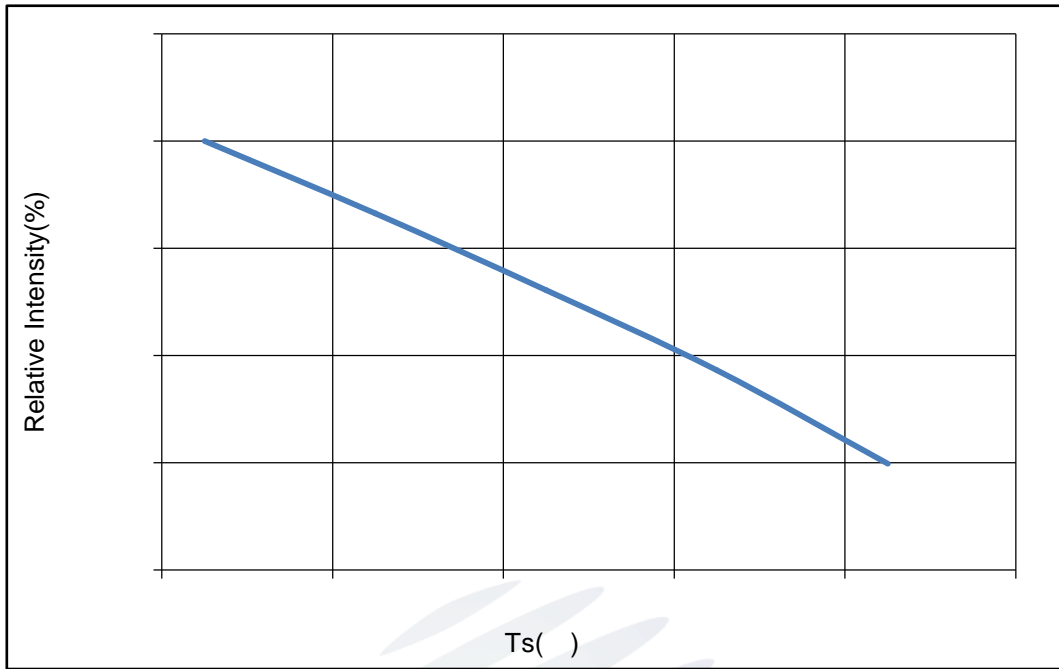

Fig. 1-9 Solder Temperature Vs Relative Intensity

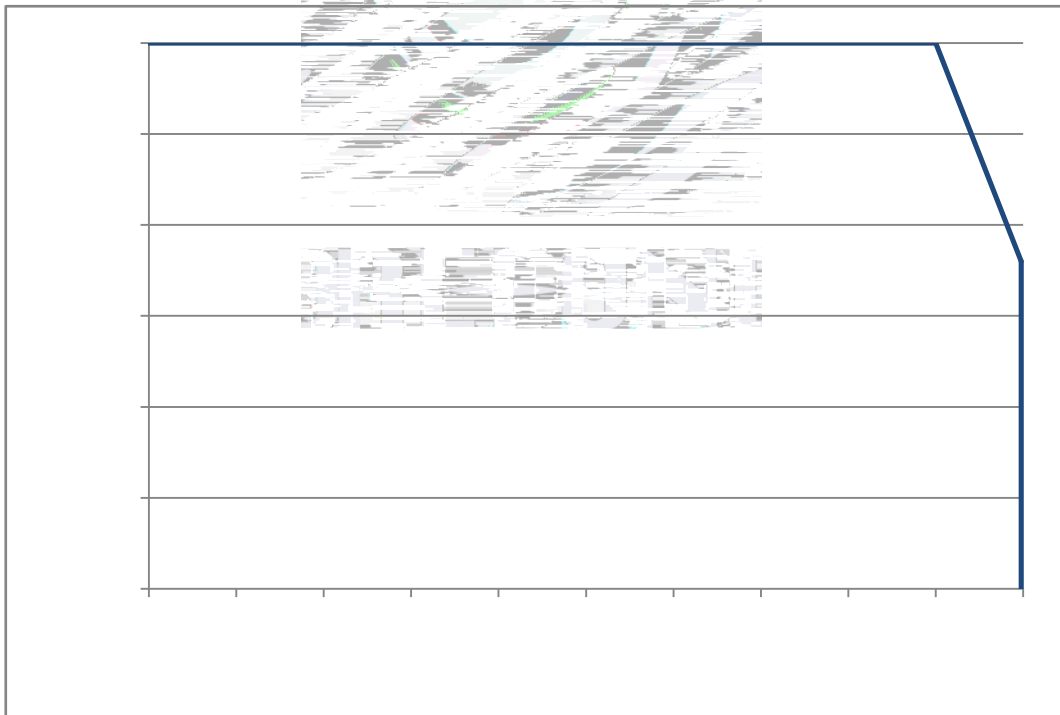
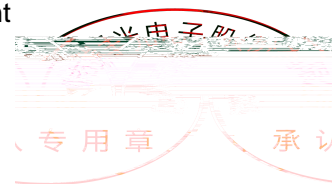

Fig. 1-10 Solder Temperature Vs Forward Current



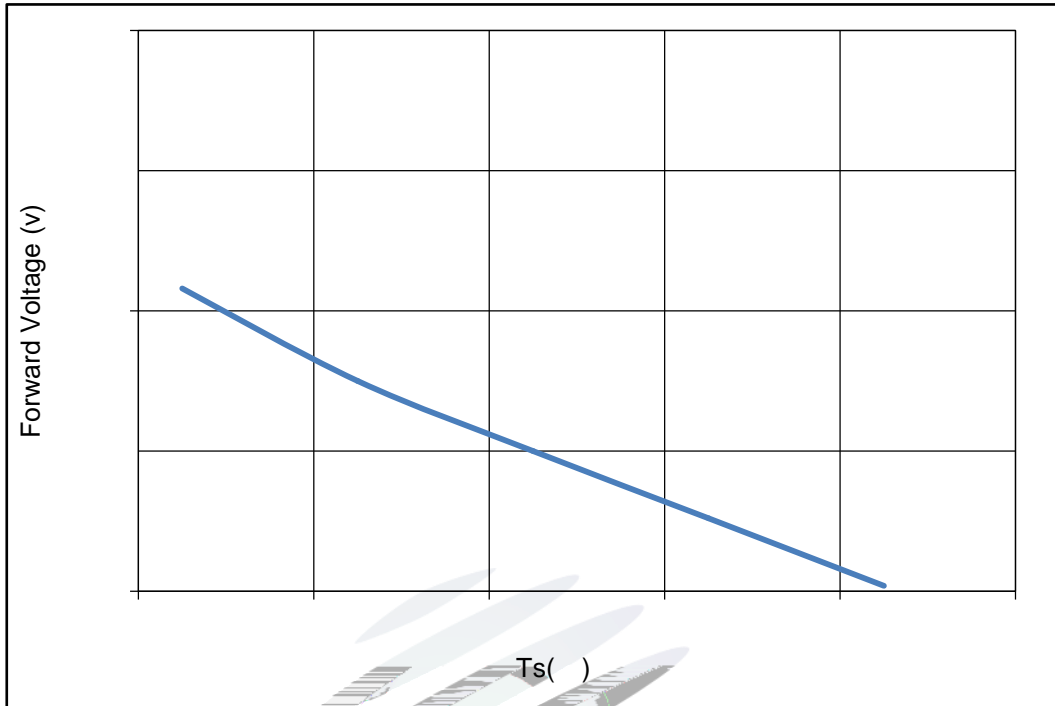

Fig. 1-11 Forward Voltage Vs Solder Temperature

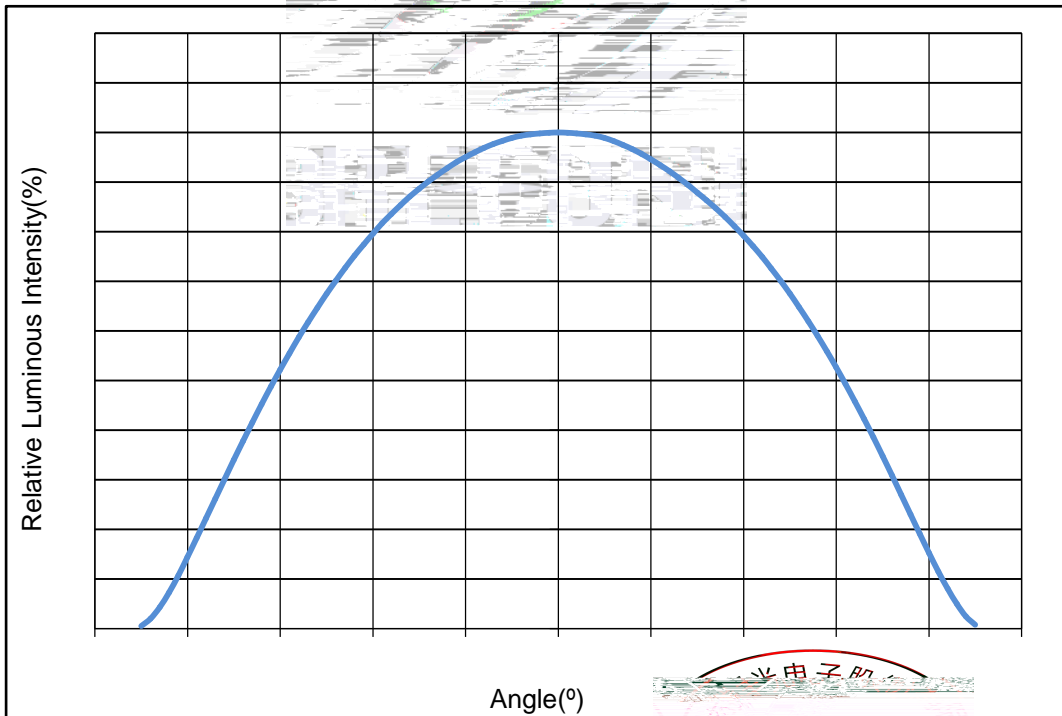
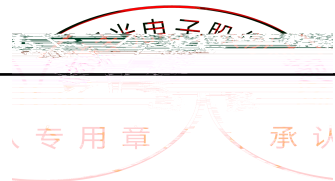

Fig. 1-12 Radiation diagram



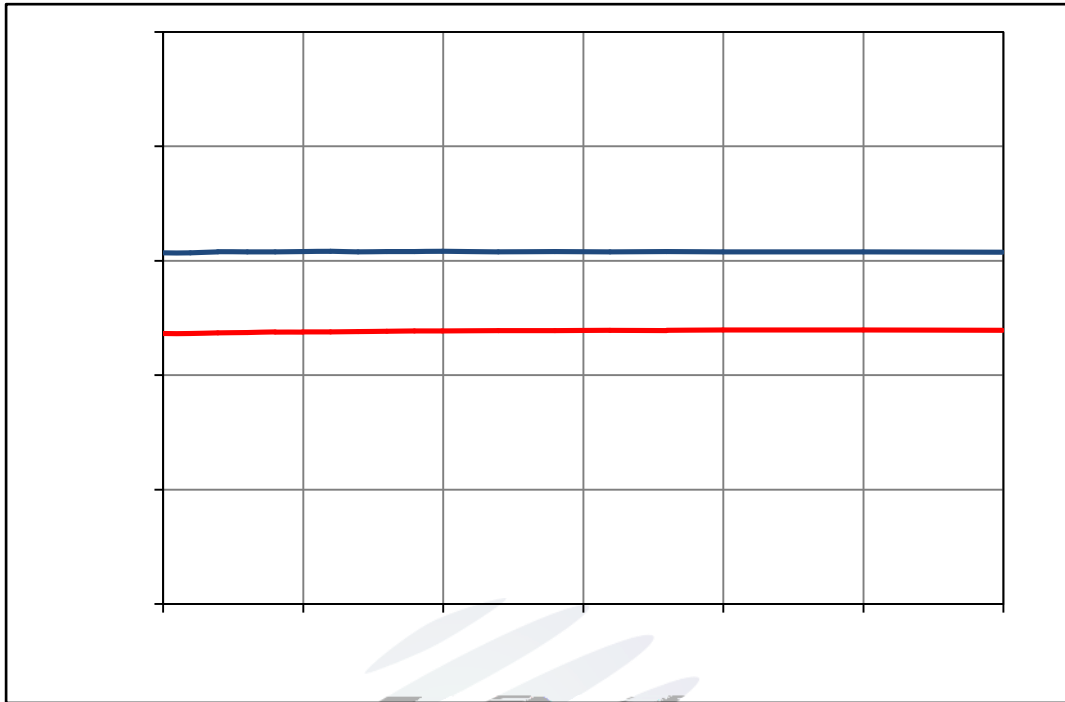

Fig. 1-13

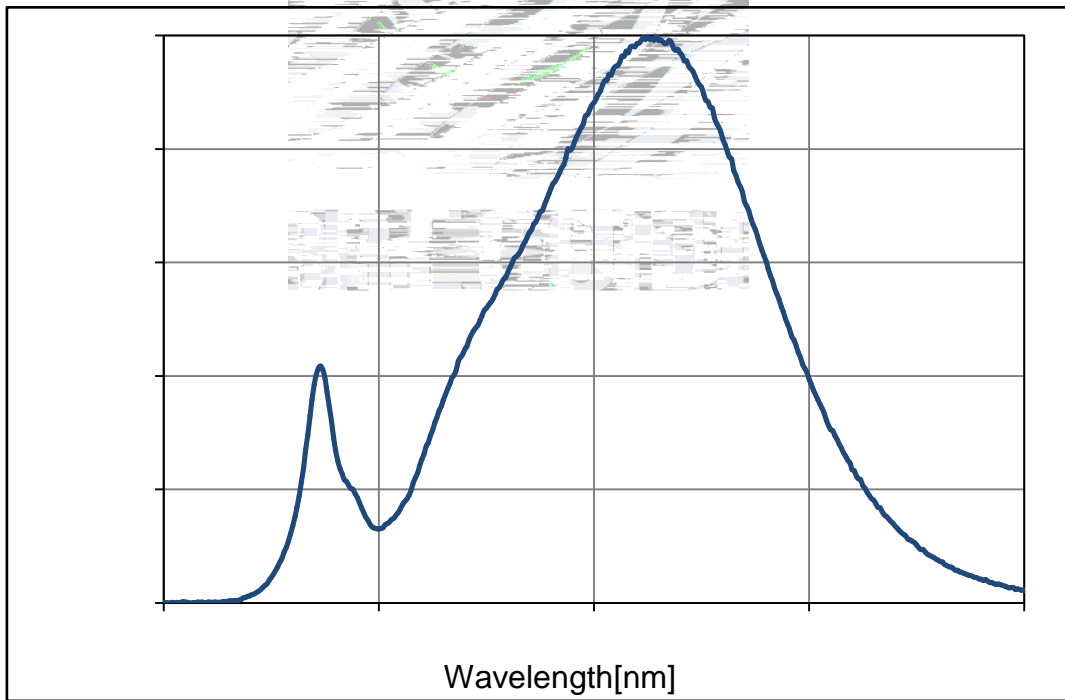

Fig. 1-14 Spectrum Distribution

2.1.3 Label Form Specification



Fig. 2-3 Label Form Specification

Table 2-2 Label Form Specification

PART NO.	Part Number
SPEC NO.	Spec Number
LOT NO.	Lot Number
BIN CODE	Bin Code
IV	Luminous flux
XY	Chromaticity Bin
V _F	Forward Voltage
WLD	Wavelength
QTY	Packing Quantity
DATE	Made Date

2.2 Moisture Resistant Packing 防潮包装

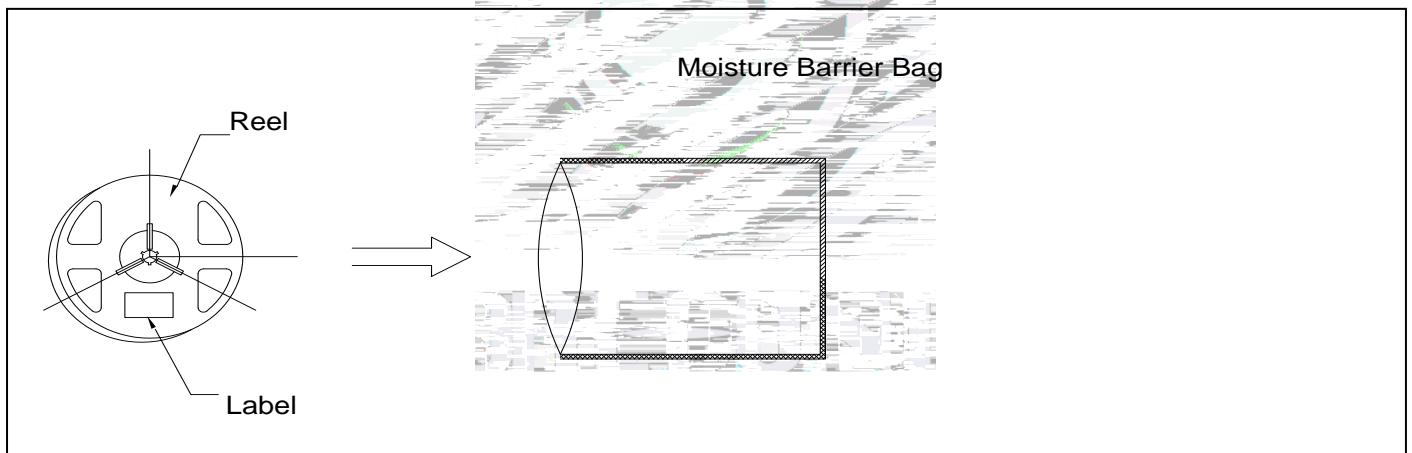
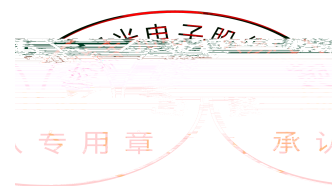

Fig.2-4 Moisture Resistant Packing





2.3 Cardboard Box 包装纸箱

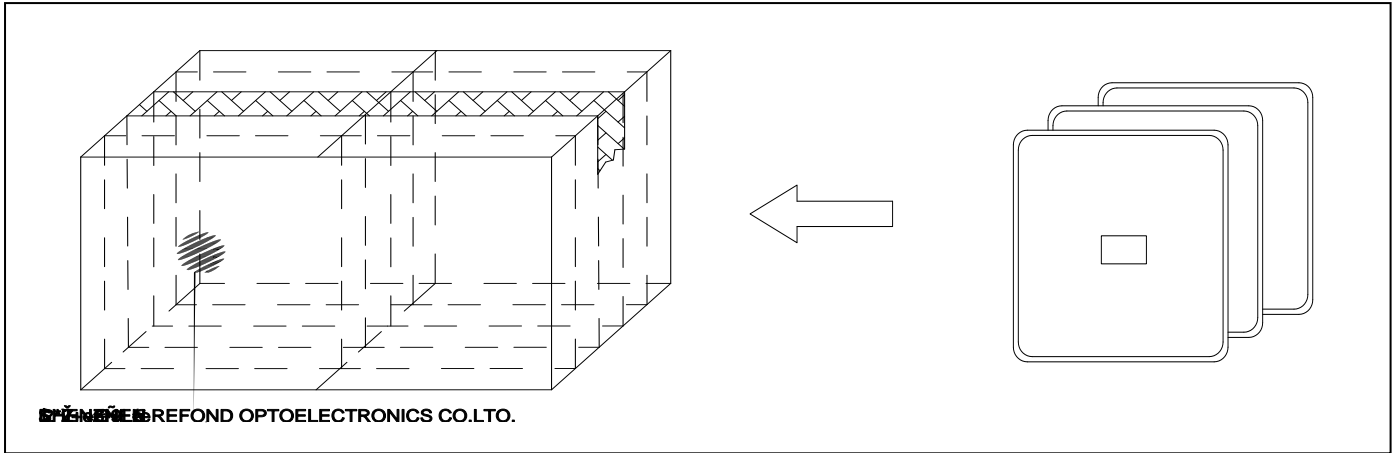

Fig.2- Cardboard Box

2.4 Reliability Test Items And Conditions 信赖性测试项目及条件

Table 2-3 Reliability Test Items And Conditions

Test Items	Ref. Standard	Test Condition	Time	Quantity	Ac/Re /
Reflow	JESD22-B106	Temp:260 max T=10 sec	2times	20pcs.	0/1
Thermal Shock	JEITAED-4701 300307	-40 15min 10s 125 15min	1000 cycle	20pcs.	0/1
High Temperature Storage	JEITAED-4701 200 201	Temp:125	1000hrs.	20pcs.	0/1
Low Temperature Storage	JEITA ED-4701 200 202	Temp:-40	1000hrs.	20pcs.	0/1
Life Test	JESD22-A108	Ta=25 If=20mA	1000hrs.	20pcs.	0/1



High Temperature High Humidity Life Test	JESD22-A101	85 / 85%RH I _F =20mA	1000hrs.	20pcs.	0/1
Temperature Humidity Storage	JEITA ED-4701 100 103	T _A =85 R _H =85%	1000hrs.	20pcs.	0/1

2.5 Criteria For Judging Damage 失效判定标准

Table 2-4 Criteria For Judging Damage

Test Items	Symbol	Test Condition	Criteria For Judgement	
			Min.	Max.
Forward Voltage	V _F	I _F =20mA	-	U.S.L*)x1.1
Reverse Current	I _R	V _R = 5V	-	U.S.L*)x2.0
Luminous Flux		I _F =20mA	L.S.L*)x0.7	-

Notes

- 1.U.S.L: Upper standard level L.S.L: Lower standard level
- 2.The above reliability tests is based on the verification of a single/strip LED of Refond's existing experimental platform,the reliability experiment was taken under good heat dissipation conditions. when customers applies the LED to the series and parallel circuit, should take consideration of all the factors such as the current, voltage distribution, heat dissipation and others.

LED





3.The technical information shown in the data sheets is limited to the typical characteristics and circuit examples





(T _P)	5 °C	Hold time within 5	30	Max 30s
C with the actual peak temperature (TP)				
Cooling speed			6 °C/	Max 6 °C/ s
25 °C	Needed time from 25 °C to T _p		8	Max 8 minutes

Notes

(1)Reflow soldering should not be done more than twice. If more than 24 hours between the two solderings , LED will be damaged. 24 LED

(2)When soldering , do not put stress on the LEDs during heating.

3.1.1 Soldering Iron

(1) When do soldering by hand, keep the temperature of iron below less 300 less than 3 seconds , 300 3

(2) Soldering by hand should be done only one time.

3.1.2 Repairing

Repairing should not be done after the LEDs have been soldered. When repairing is unavoidable,a double-head soldering iron should be used (as below figure). It should be confirmed in advance whether the characteristics of LEDs will or not be damaged by repairing.

LED

LED

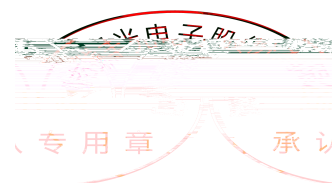



3.1.3 Cautions



energy. The result can be a significant loss of light output from the fixture. Knowledge of the properties of the materials selected to be used in the construction of fixtures can help prevent these issues. Refond advises against the use of any chemicals or materials that have been found or are suspected to have an adverse affect on device performance or reliability. To verify compatibility, Refond recommends that all chemicals and materials be tested in the specific application and environment for which they are intended to be used. Attaching LEDs, do not use adhesives that outgas organic vapor.

LED

LED

LED

(4) Handle the component along the side surface by using forceps or appropriate tools; Do not directly touch or Handle the silicone lens surface, it may damage the internal circuitry.

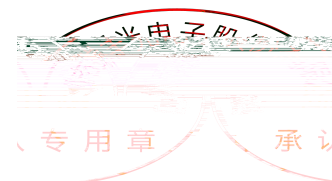

Fig 4-1 Handling Precautions 产品使用注意事项

(5) In designing a circuit,the current through each LED can not exceed the absolute maximum rating specified for each LED.In the mean while,resistors for protection should be applied,other wise slight voltage shift will cause big current change,burn out may happen. The driving circuit must be designed to allow forward voltage only when it is ON or OFF.If the reverse voltage is applied to LED, migration can be generated resulting in LED damage.

LED

LED



(6) Thermal Design is paramount importance because heat generation may result in the Characteristics decline, such as brightness decreased, Color change and so on. Please consider the heat generation of the LEDs when making the system design. LED

LED

(7) Compared to standard encapsulants, silicone is generally softer, and the surface is more likely to attract dust, requiring special care during processing. In cases where a minimal level of dirt and dust particles cannot be guaranteed, a suitable cleaning solution must be applied to the surface after the soldering of components. Refond suggests using isopropyl alcohol for cleaning. In case other solvents are used, it must be assured that these solvents do not dissolve the package or resin. Ultrasonic cleaning is not recommended. Ultrasonic cleaning may cause damage to the LED.

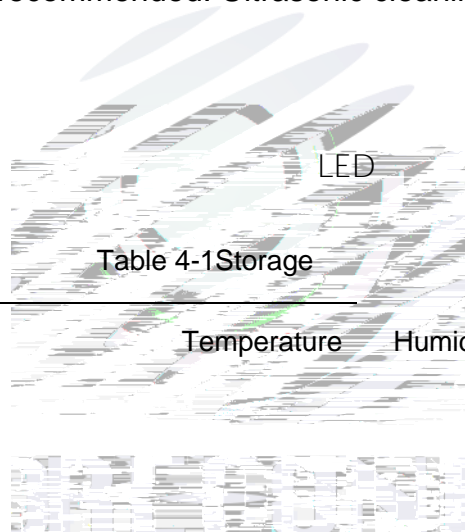

Conditions

Temperature

Humidity

Time

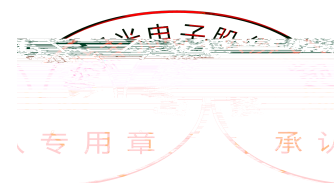



following condition 65±5 for above 24 hours.

60 5 24

If the package is flatulence or damaged, please notify the sales staff to assist.

(9) Similar to most Solid state devices; LEDs are sensitive to Electro-Static Discharge (ESD) and Electrical Over Stress (EOS). LED

(10) Other points for attention, please refer to our relevant information.

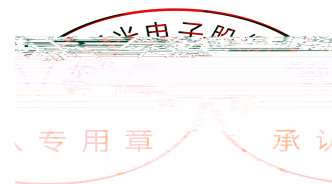



www.refond.com

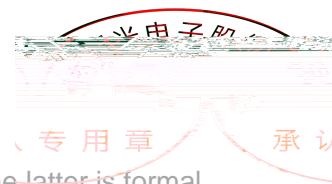

Declare

This specification is written both in English and in Chinese and the latter is formal.