

SPECIFICATION 产品规格书

REFOND P/N 产品型号

RF-P28Q3-IRN-FT

R&D 研发

Mass Product 量产供货



Contents 目錄

1. Description 产品介绍	
1.1 General Description 产品描述	
1.2 Features 产品特征	
1.3 Application 产品应用	
1.4 Package Dimension 封装尺寸	
1.5 Product Parameters 产品参数	
1.6 Typical optical characteristics curves 典型光学特性曲线	
2. Packaging 产品包装	
2.1 Packaging Specification 包装规格	
2.1.2 Reel Dimension 卷盘尺寸	10
2.1.3 Label Form Specification 标签规格	11
2.3 Cardboard Box 包装纸箱	
2.4 Reliability Test Items And Conditions 信赖性测试项目及条件	
2.5 Criteria For Judging Damage 失效判定标准	
3. SMT Reflow Soldering Instructions SMT 回流焊说明	
3.1 SMT Reflow Soldering Instructions SMT 回流焊说明	
4. Handling Precautions 产品使用注意事项	
4.1 Handling Precautions 产品使用注意事项	



1. Description

1.1 产品描述

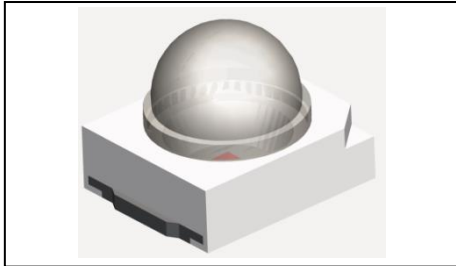

This product uses the PPA package, it has a high reliability. it also be widely application for security monitoring and senso.

Size(mm): 2.80mmX3.50mmX2.60mm.

本产品采用PPA封装结构，可靠性高。

产品尺寸：2.80mmX3.50mmX2.60mm

1.2 Features 产品特征

Low forward voltage.

850nm. 峰值波长 850nm

Pb-free reflow soldering application. 无铅回流焊应用

Moisture sensitive level:Level5. 防潮等级：Level 5

RoHS compliant. 符合RoHS

1.3 Application 产品应用

Surveillance systems. 监视系统

Infrared Illumination for cameras. 红外相机

Machine vision systems. 机器视觉系统



1.4 Package Dimension 封装尺寸

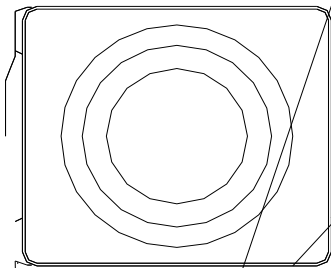

Fig.1-1 Top view 正面视图

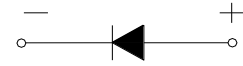

Fig.1-2 Polarity 极性

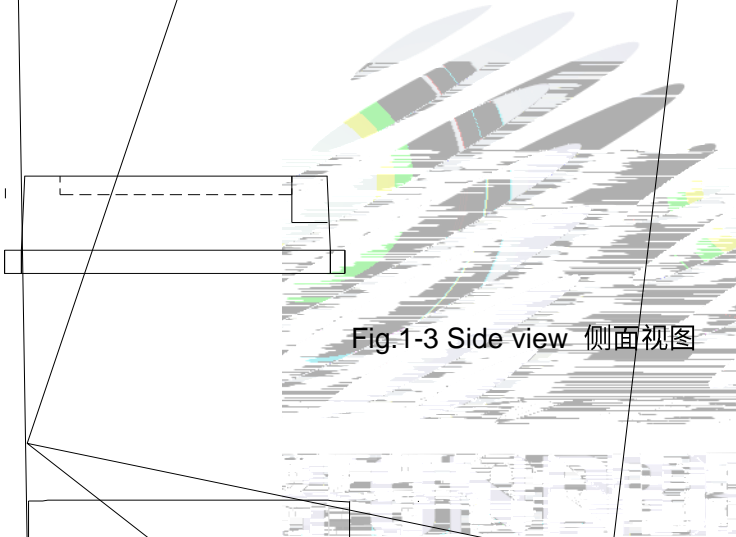

Fig.1-3 Side view 侧面视图

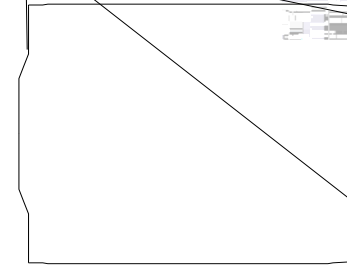

Fig.1-4 Bottom view 背面视图

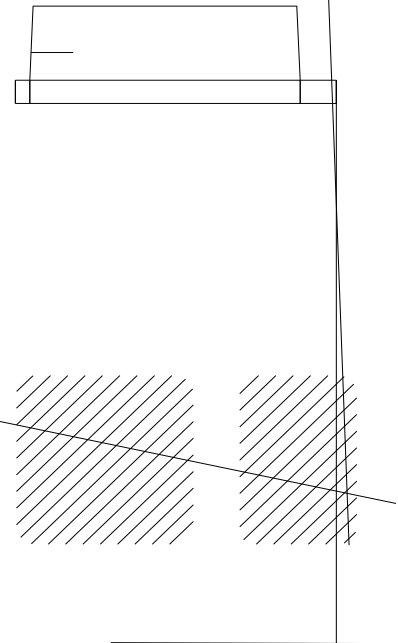

Fig.1-5 Soldering patterns 推荐焊

Notes 备注:

1. All dimensions units are millimeters. 所有尺寸标注单位为毫米
2. All dimensions tolerances are $\pm 0.2\text{mm}$ unless otherwise noted.



公差 ± 0.2 毫米

1.5 Product Parameters 产品参数

Table 1-1 Electrical / Optical Characteristics at Ts=25°C 电性与光学特性

Item 项目	Symbol 符号	Test Condition 测试条件	Value			Unit 单位
			Min. (最小值)	Typ (典型值)	Max. (最大值)	
Reverse Current (漏电流)	I_R	$V_R=5V$	---	---	10	μA
Forward Voltage (正向电压)	V_F	$I_F=100mA$	1.4	1.6	---	V
Peak Wavelength (峰值波长)	λ_p	$I_F=100mA$	---	850	---	nm
Spectrum Radiation Bandwidth 半波宽		$I_F=100mA$	---	45	---	nm
Total radiant flux 辐射功率	ϕ_e	$I_F=100mA$	45	65	---	mW
Viewing Angle (发光角度)	2	$I_F=100mA$	---	17	---	deg
Thermal Resistance. (热阻)	R_{THJ-S}	$I_F=100mA$	---	50	---	$^{\circ}C/W$



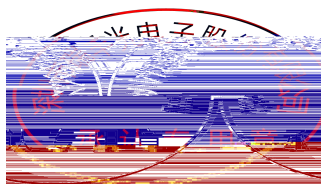
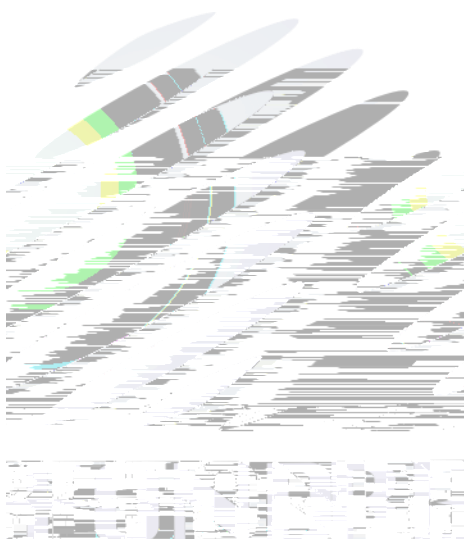

1.6 Typical optical characteristics curves 典型光学特性曲线

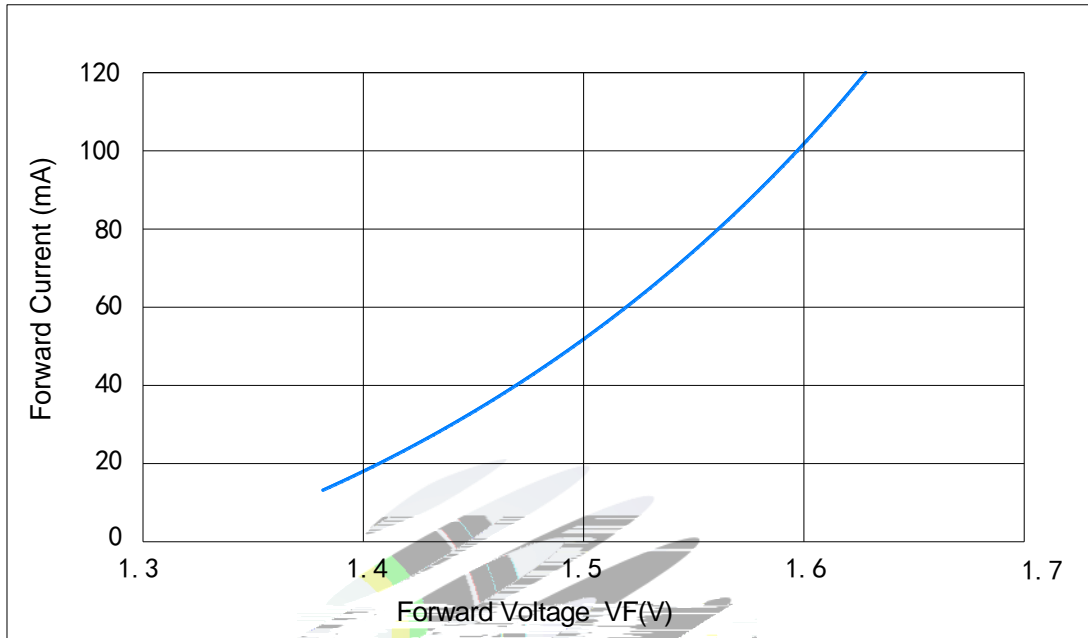

Fig 1-6 Forward Voltage Vs. Forward Current 伏安特性曲线

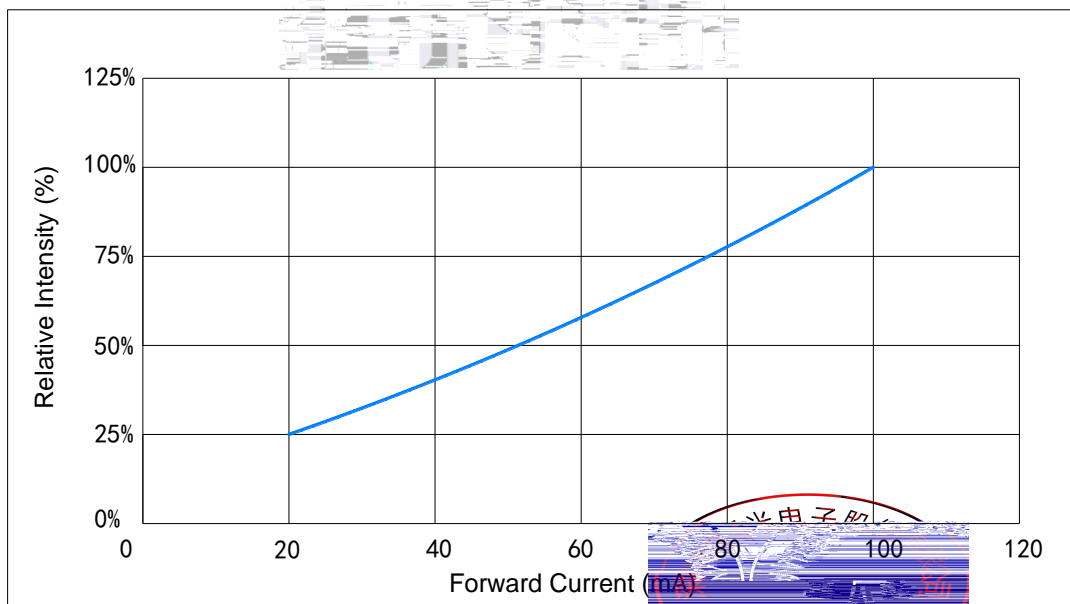

Fig 1-7 Forward Current Vs. Relative Intensity 正向电流与相对光强特性曲线

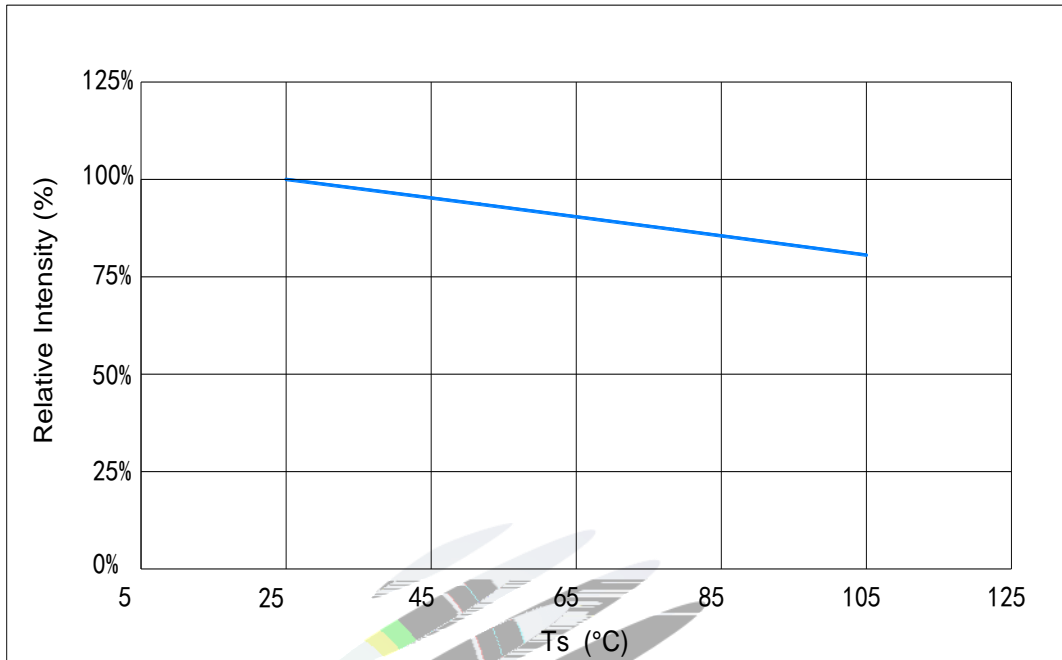

Fig 1-8 Ts Temperature Vs Relative Intensity 管脚温度与相对光强特性曲线

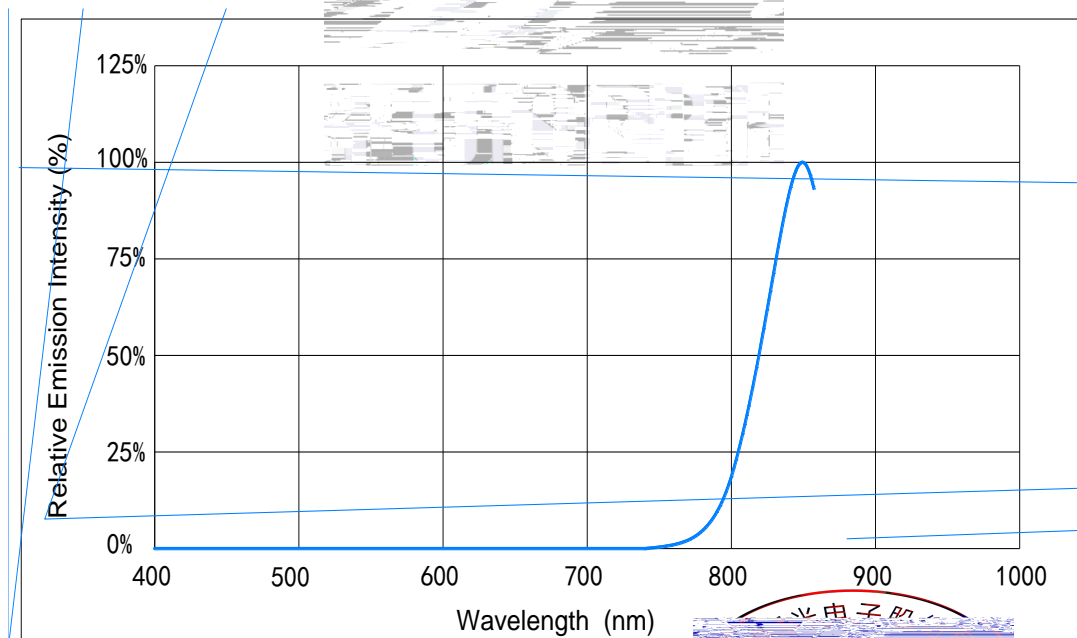

Fig 1-9 Spectrum Distribution 光谱分布特性曲线

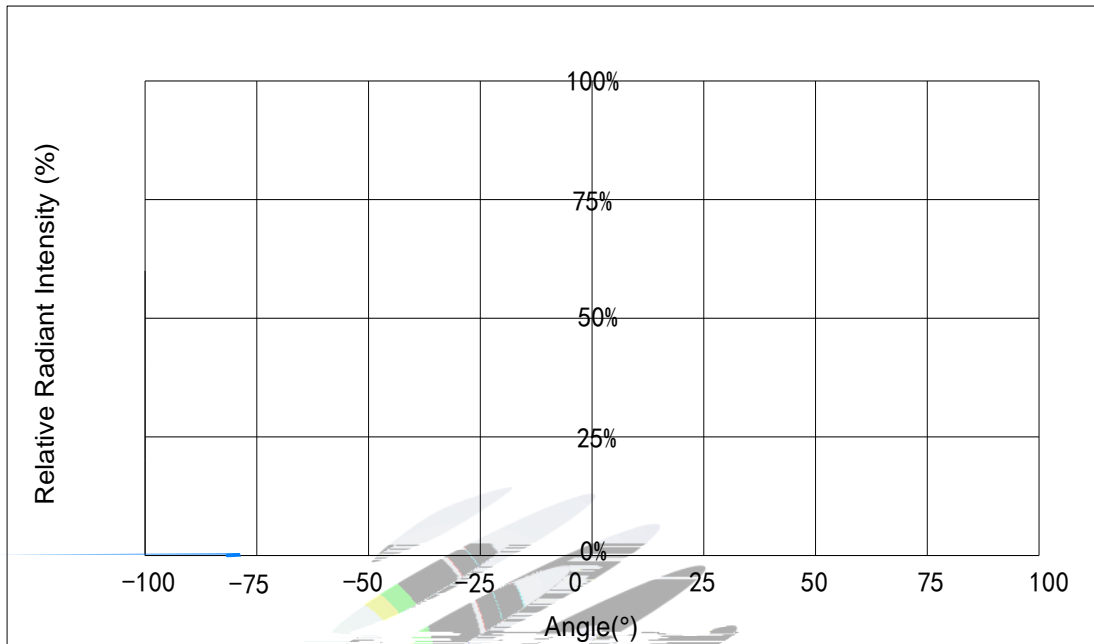

Fig 1-10 Radiation diagram 辐射特性曲线

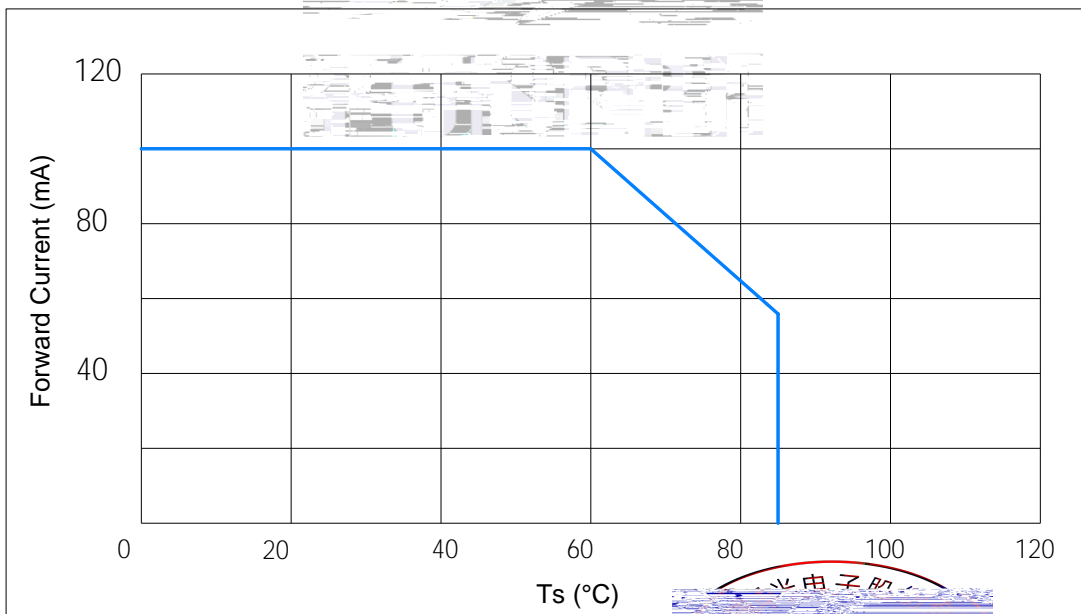
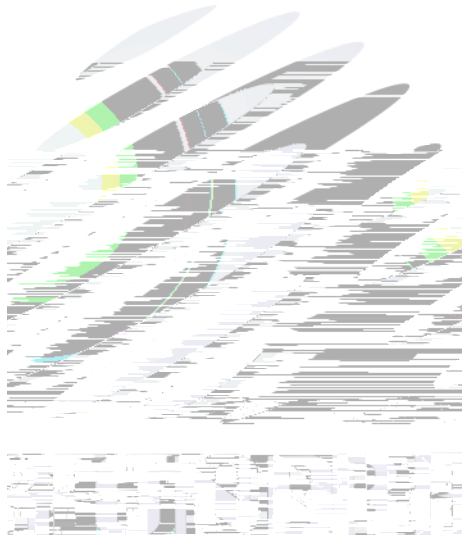

Fig 1-11 Ts Temperature Vs Forward Current 管脚温度与正向电流特性曲线

2. Packaging 产品包装

2.1 Packaging Specification 包装规格

Package:3000pcs/reel.包装每卷 3000pcs.



2.1.3 Label Form Specification 标签规格

Table 2-2 Label Form Specification

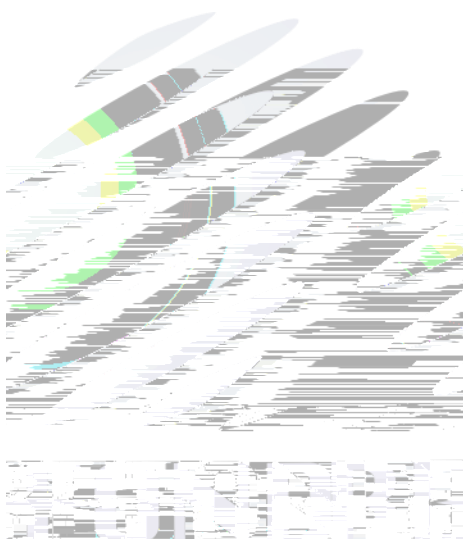

2.4 Reliability Test Items And Conditions 信赖性测试项目及条件

Table 2-3 Reliability Test Items And Conditions 信赖性测试项目及条件

Test Items 项目	Ref.Standard 参考标准	Test Condition 测试条件	Time 时间	Quantity 数量	Ac/Re 接收/拒收
Reflow 回流焊	JESD22-B106	Temp:260°Cmax T=10 sec	3times.	10Pcs.	0/1
Temperature Cycle 温度循环	JESD22-A106	100°C 30 min. -40°C 30 min.	100 cycles	10Pcs.	0/1
Thermal Shock 冷热冲击	JESD22-A104	-40°C 15min 10s 100°C 15min	300 cycles	10Pcs.	0/1
High Temperature Storage 高温保存	JESD22-A103	Temp:100°C	1000 hrs.	10Pcs.	0/1
Low Temperature Storage 低温保存	JESD22-A119	Temp:-40°C	1000 hrs.	10Pcs.	0/1
Life Test 常温通电	JESD22-A108	Ta=25°C If=100mA	1000 hrs.	10Pcs.	0/1



2.5 Criteria For Judging Damage 失效判定标准

Table Criteria For Judging Damage 失效判定标准

Test Items 项目	Symbol 符号	Test Condition 测试条件	Criteria For Judgement 判定标准	
			Min. 最小	Max. 最大
Forward Voltage 正向电压	V_F	$I_F=100mA$	-	U.S.L*)x1.1
Reverse Current 反向电流	I_R	$V_R = 5V$	-	U.S.L*)x2.0

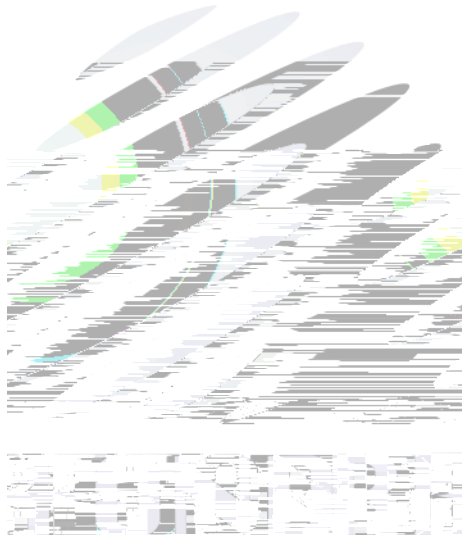

3. SMT Reflow Soldering Instructions SMT 回流焊说明

3.1 SMT Reflow Soldering Instructions SMT 回流焊说明

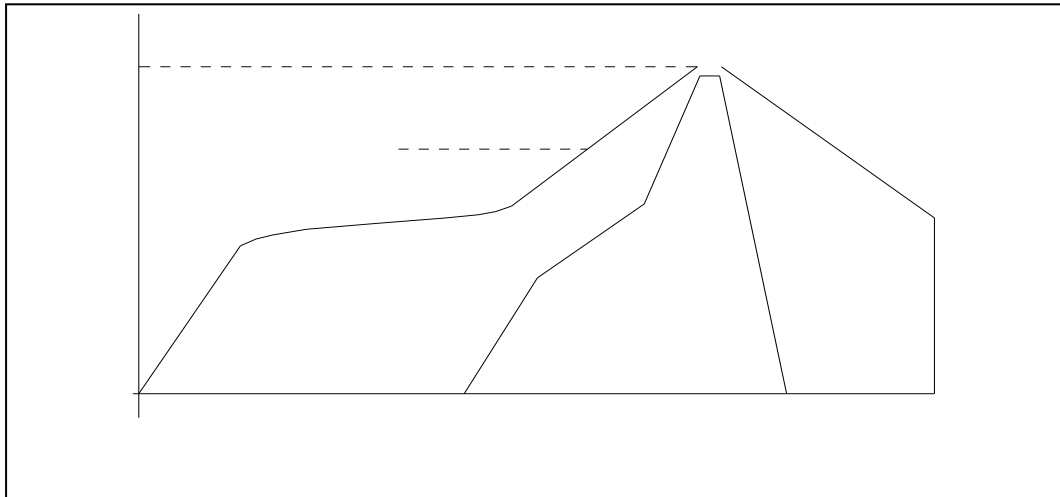

Fig.3-1 SMT Reflow Soldering Instructions SMT 回流焊说明

Table 3-1 Parameter 参数

Average temperature rise speed平均升温速度 (T _{max} 至 T _P)	最高3 °C/秒 Max 3 °C/ s
Preheating: minimum temperature预热: 最低温度 (T _{min})	160°C
Preheating: Max temperature预热: 最高温度 (T _{max})	180°C
Preheating: Time预热: 时间 (T _{min} 至 T _{max})	60 - 120秒 60s-120s
Time limited to maintain high temperature: the temperature限时维持高温: 温度(T _L)	200 °C
Time limited to maintain high temperature: The Time 限时维持高温: 时间 (t _L)	最多60秒 Max 60s
Peak /Classification of temperature:峰值 / 分类温度 (T _P)	220 °C
Time limit classification of peak temperature time限时峰值分类温度: 时间 (t _p)	最多5秒 Max 5s
Hold time within 5 °C with the actual peak temperature (TP) 与实际峰值温度 (TP) 相差 5 °C 以内的保持时间	最多30秒 Max 30s
Cooling speed 降温速度	最高6 °C/秒 Max 6 °C/ s
Needed time from 25 °C to T _p 25 °C 升至峰值温度所需时间	最多8分钟 Max 8 minutes

Notes 备注:

(1) Reflow soldering should not be done more than two times. In the case of more than 24 hours passed soldering after first, LEDs will be damaged. 回流焊次数不可以超过两次，两次回流焊的时间间隔如果超过24小时，LED可能由于吸湿而损坏。

(2) When soldering , do not put stress on the LEDs during heating.当焊接时，不要在材料受热时用力压胶体表面。

3.1.1 Soldering Iron 烙铁焊接

(1) When hand soldering, keep the temperature of iron below less 300°C less than 3 seconds 当手工焊接时，烙铁的温度必须小于300°C，时间不可超过3秒。

(2) The hand solder should be done only one time.手工焊接只可焊接一次。

3.1.2 Repairing 修补

Repair should not be done after the LEDs have been soldered. When repairing is unavoidable, a double-head soldering iron should be used (as below figure). It should be confirmed in advance whether the characteristics of LEDs will or will not be damaged by repairing.

LED 的特性。 LED本身

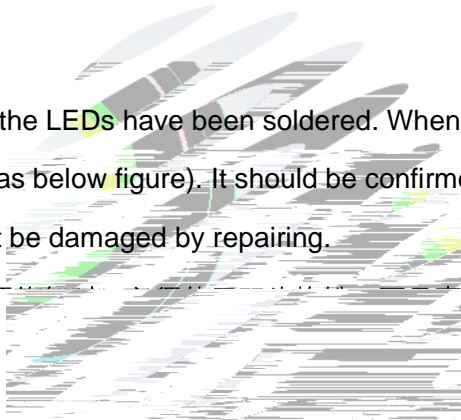

3.1.3 Cautions 注意事项

(1) Components should not be mounted on warped (non coplanar) portion of PCB. After soldering, do not warp the circuit board.LED 灯珠不要焊接在弯曲的 PCB 板上，焊接之后，也不要弯折线路板。

(2) Do not apply mechanical force or excess vibration during the cooling process to normal temperature after soldering. Do not rapidly cool device after soldering. 回流焊之后冷却过程中，不要对材料施加外力，也不要有震动，回流焊后，不要采用激剧冷却的方式。

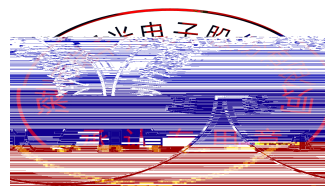

4. Handling Precautions 产品使用注意事项

4.1 Handling Precautions 产品使用注意事项

(1) LED operating environment and sulfur element composition cannot be over 100PPM in the LED mating usage material. This is provided for informational purposes only and is not a warranty or endorsement. LED 工作环境及与 LED 适配的材料中硫元素及硫化合物含量不得超过 100PPM. 这只是一个建议，不作任何品质担保。

(2) In order to prevent external material from getting into the inside of LED, which may cause the malfunction of LED, the single content of Bromine element is required to be less than 900PPM, the single content of Chlorine element is required to be less than 900PPM, the total content of Bromine element and Chlorine element in the external materials of the application products is required to be less than 1500PPM. This is provided for informational purposes only and is not a warranty or endorsement. 为了防止外界物质进入 LED 内部以造成 LED 的损伤，所处环境及所用套件等等，单一的溴元素含量要求小于 900PPM，单一氯元素含量要求小于 900PPM，溴元素与氯元素总含量必须小于 1500PPM. 这只是一个建议，不作任何品质担保。

(3) VOCs (Volatile organic compounds) emitted from materials used in the construction of fixtures can penetrate silicone encapsulants of LEDs and discolor when exposed to heat and photonic energy. The result can be a significant loss of light output from the fixture. Knowledge of the properties of the materials selected to be used in the construction of fixtures can help prevent these issues. Refond advises against the use of any chemicals or materials that have been found or are suspected to have an adverse affect on device performance or reliability. To verify compatibility, Refond recommends that all chemicals and materials be tested in the specific application and environment for which they are intended to be used. Attaching LEDs, do not use adhesives that outgas organic vapor. 应用套件中的挥发性物质会渗透到 LED 内部，在通电产生光及热的条件下，会导致 LED 变色，进而造成严重光衰，提前了解套件材料能够避免产生这些问题。瑞丰反对使用任何对 LED 器件的性能或者可靠性有害的物质或材料，不管这些材料是已经证实了的还是仅仅怀疑有害。针对特定的用途和使用环境，瑞丰建议对所有的物质和材料进行相容性的测试。在贴装 LED 时候，不要使用能产生有机挥发性气体的粘结剂。

(4) Handle the component along the side surface by using forceps or appropriate tools; do not directly touch or Handle the silicone lens surface, it may damage the internal circuitry.



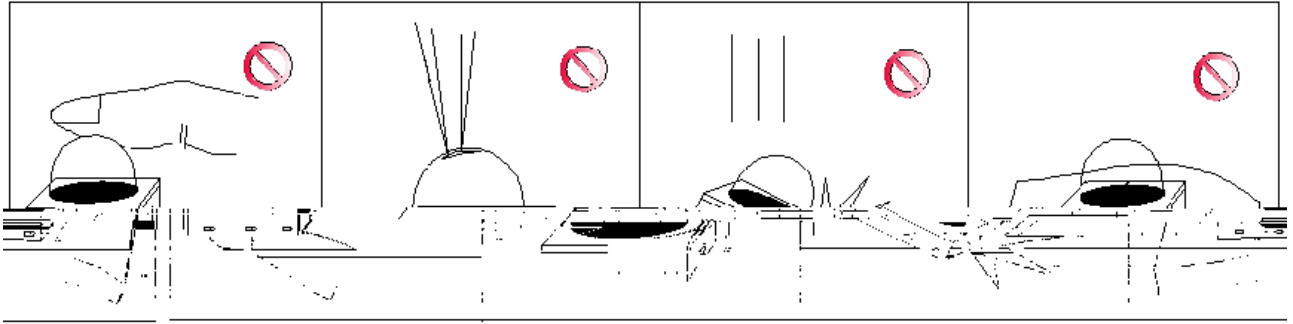

Fig 4-1

(5) In designing a circuit, the current through each LED can not be exceed the absolute maximum rating specified for each LED. In the meanwhile, resistors for protection should be applied, otherwise slight voltage shift will cause big current change, burn out may happen. The driving circuit must be designed to allow forward voltage only when it is ON or OFF. If the reverse voltage is applied to LED, migration can be generated resulting in LED damage. 设计电路时，通过 LED 的电流不能超过规定的最大值，同时，还需使用保护电阻，否则，微小电压的变化，不要施加反压，否则会损坏 LED。

(6) Thermal Design is paramount importance because heat generation may result in the Characteristics decline, such as brightness decreased, Color change and so on. Please consider the heat generation of the LEDs when making the system design. LED 容易因为自身的发热和环境的温度改变而改变，温度升高会降低 LED 发光效率，影响发光颜色，所以在设计时应当充分考虑散热问题。

Table 4-1 Storage 储存

Conditions 种类		Temperature	Humidity 湿度	Time 时间
Storage	Before Opening Aluminum Bag 拆包前	30°C	75%	Within 1 Year From Date
	After Opening Aluminum Bag 拆包后	30°C	60%	48hours 48小时
Baking 烘烤		60±5°C	-	≥24hours

(7) If the moisture absorbent material (silica gel) has faded away or the LEDs have exceeded the storage time, baking treatment should be performed after unpacking and based on the following condition (60 ± 5) °C for above 24 hours. 如果干燥剂或包装失效, 或者产品不符合以上有效储存条件, 需拆包后进行烘烤, 烘烤条件: $60\pm 5^{\circ}\text{C}$, 大于 24 小时。

If the package is flatulence or damaged, please notify the sales staff to assist. 如果包装胀气或者破损, 请通知销售人员协助处理。

(8) Similar to most Solid state devices; LEDs are sensitive to Electro-Static Discharge (ESD) and Electrical Over Stress (EOS). 像其他的半导体电子器件一样, LED 对静电过流击穿非常敏感, 需要做好防护。

(9) Other points for attention, please refer to our relevant information.

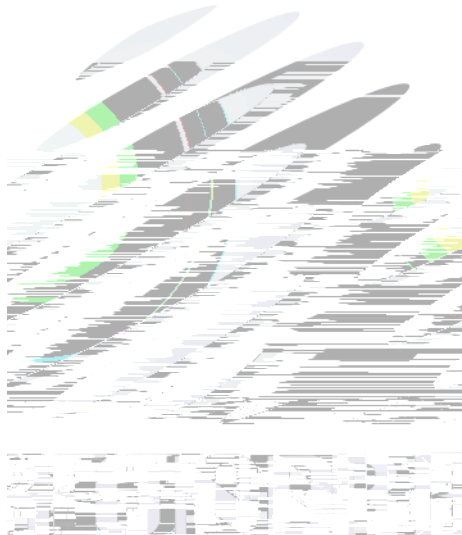



Declare 申明

This specification is written both in English and in Chinese and the product specification is written in both English and Chinese. In case of conflict, the Chinese version shall prevail.

