

±

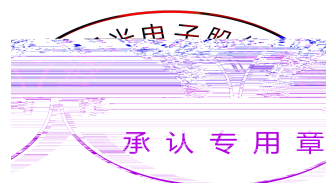

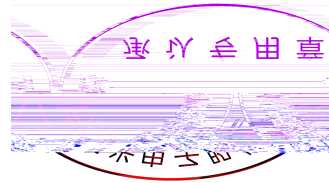

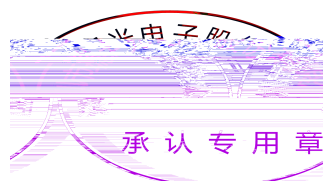

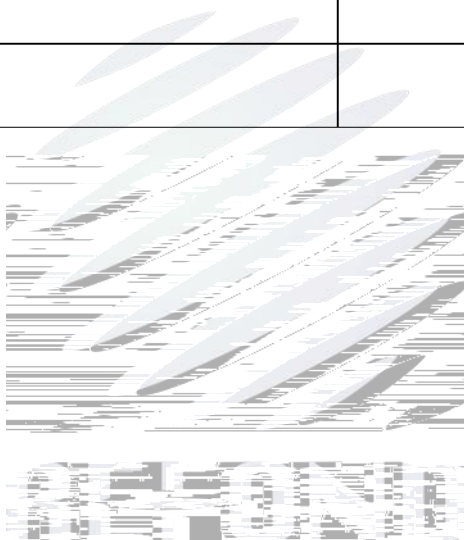

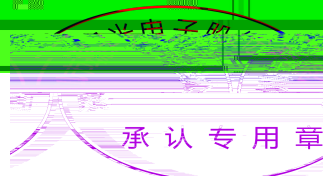
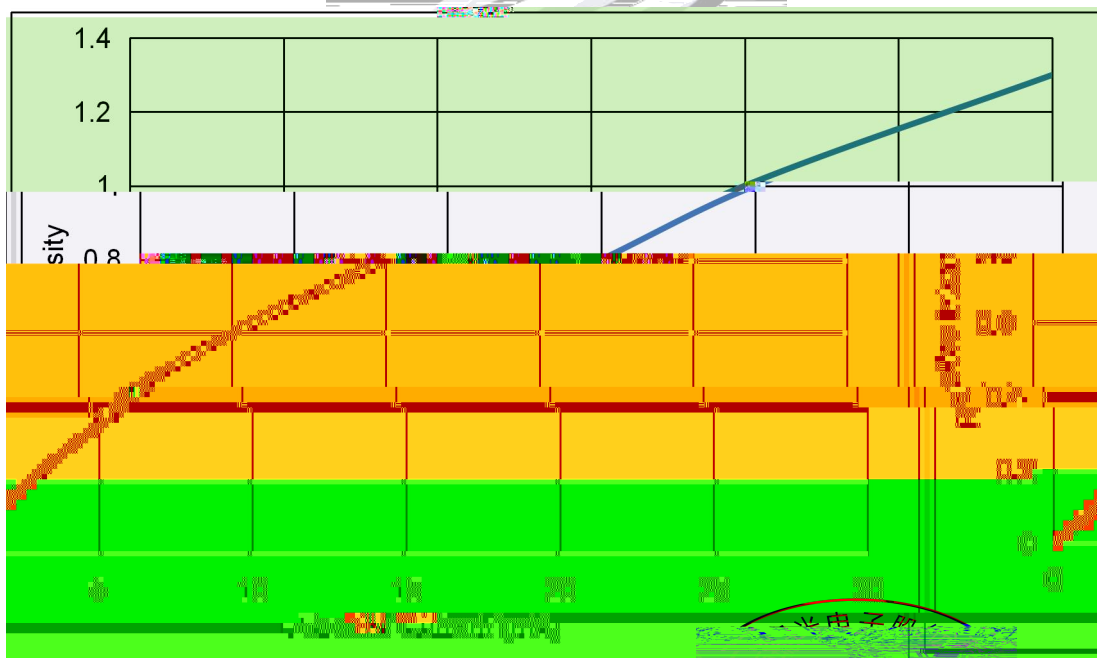
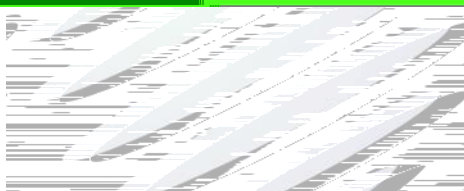
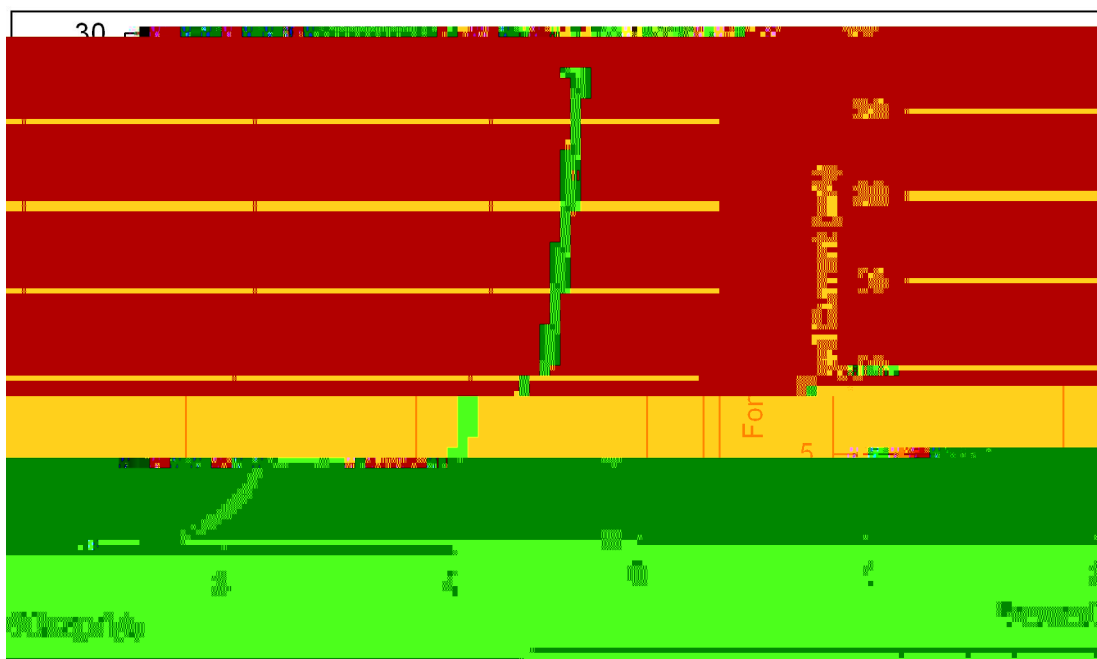



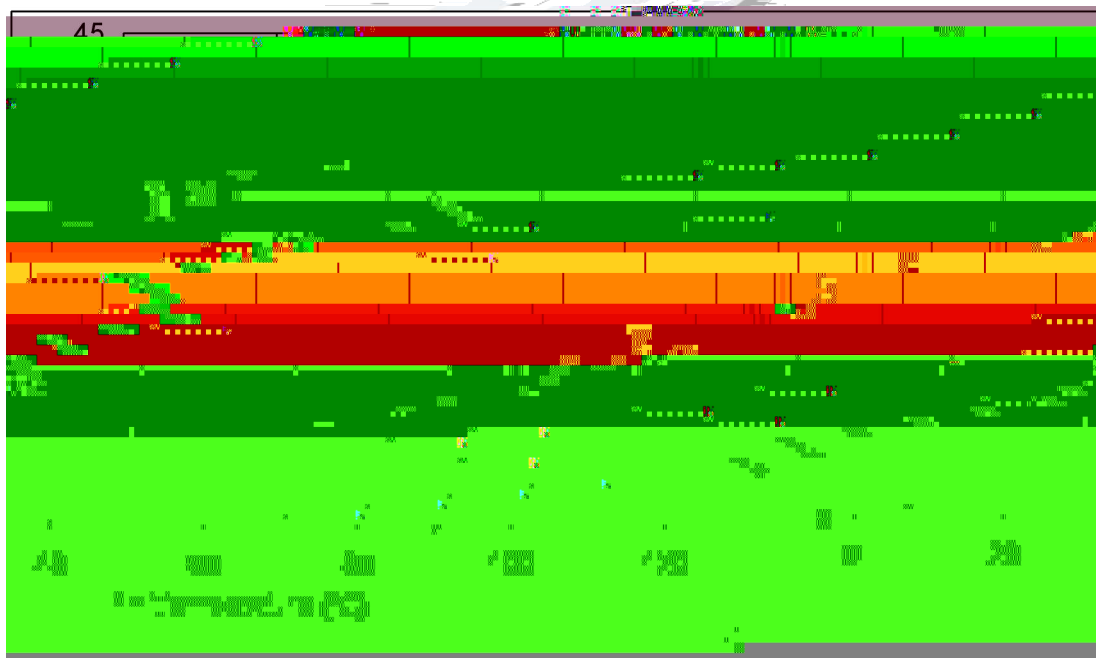
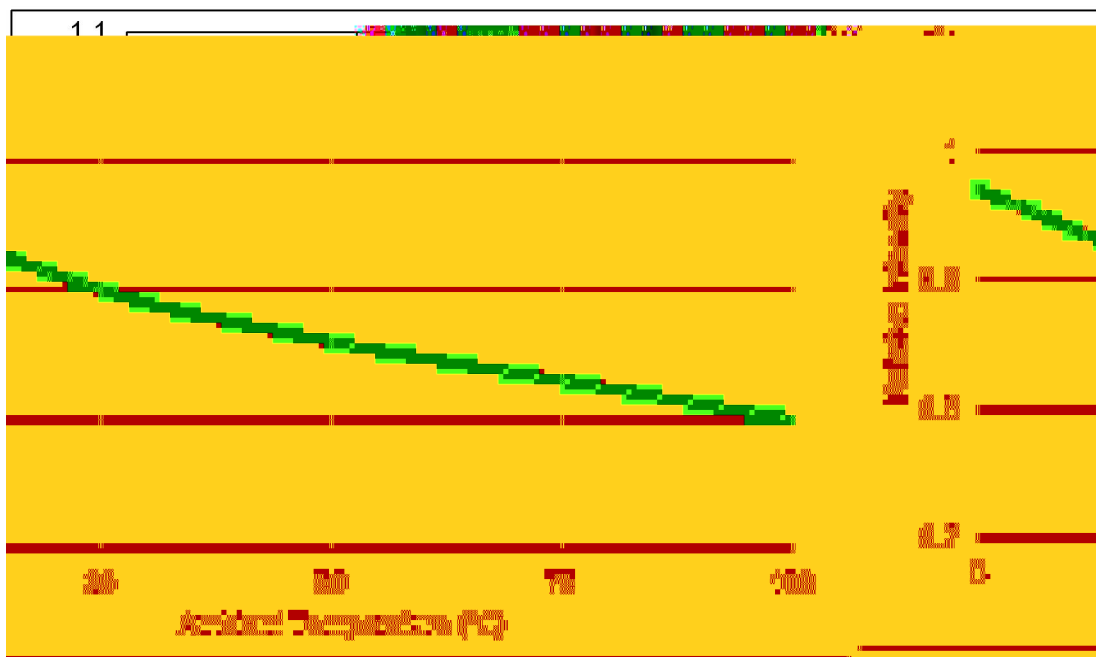

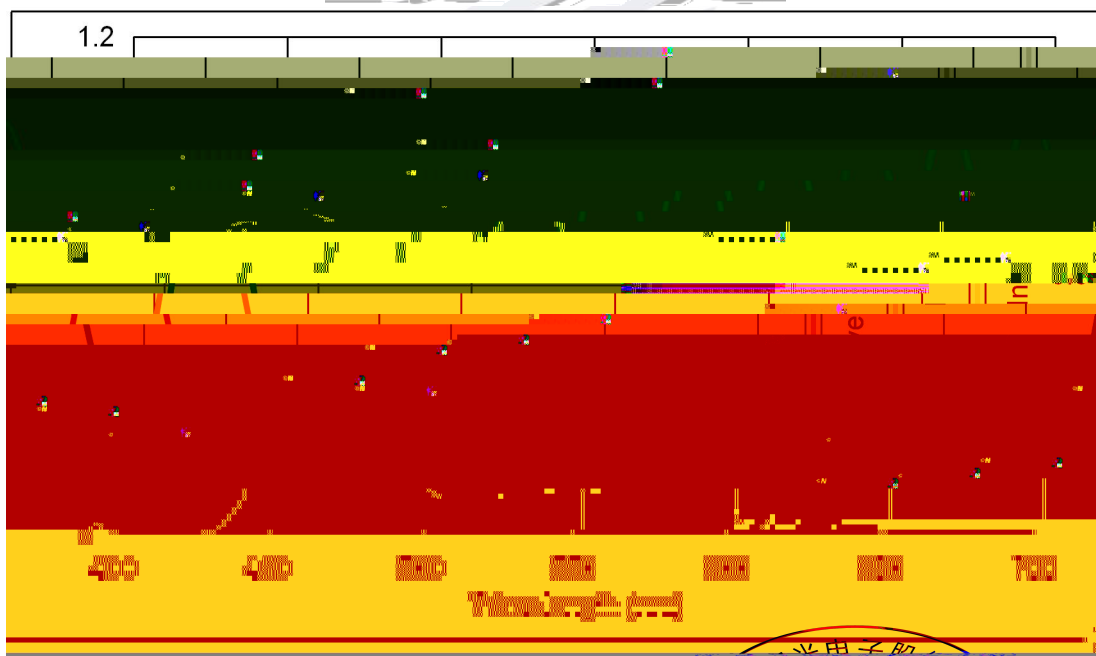
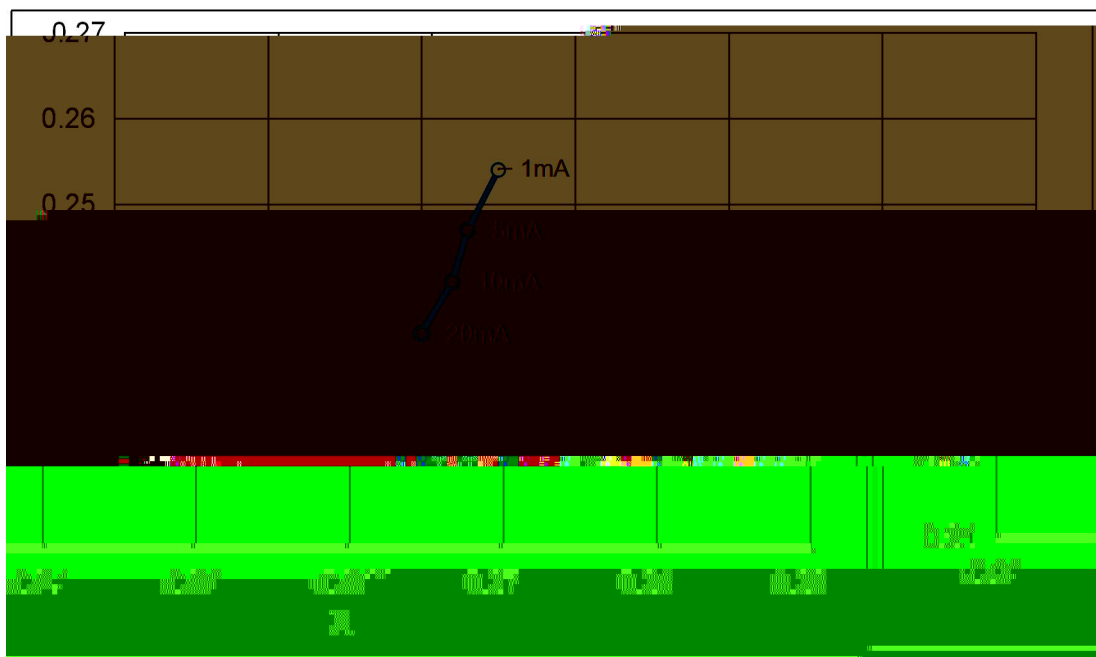



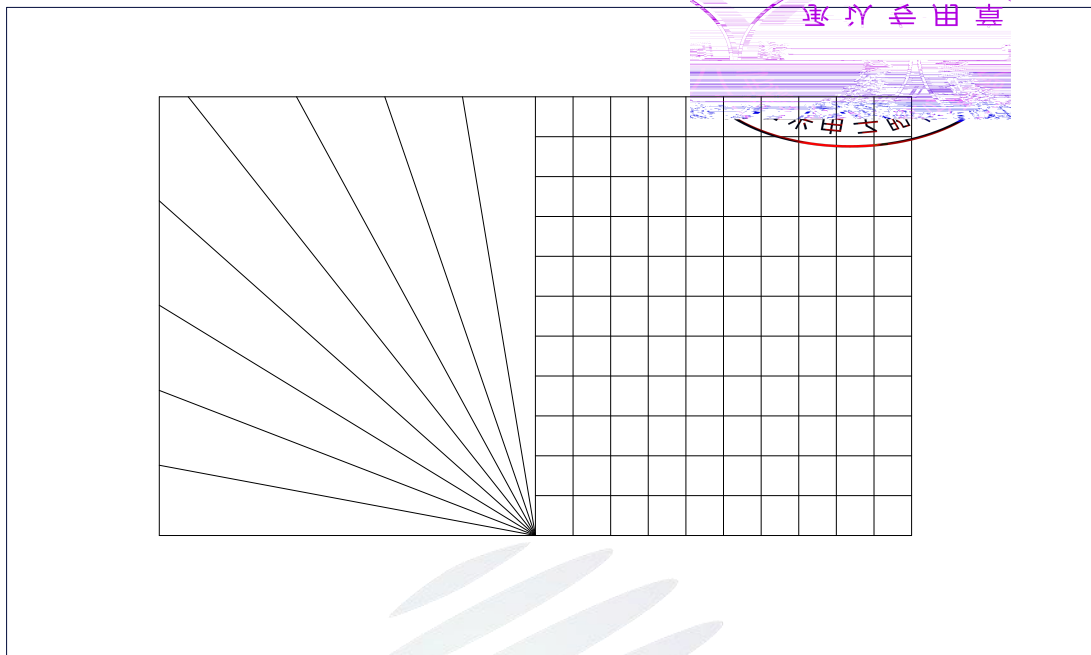

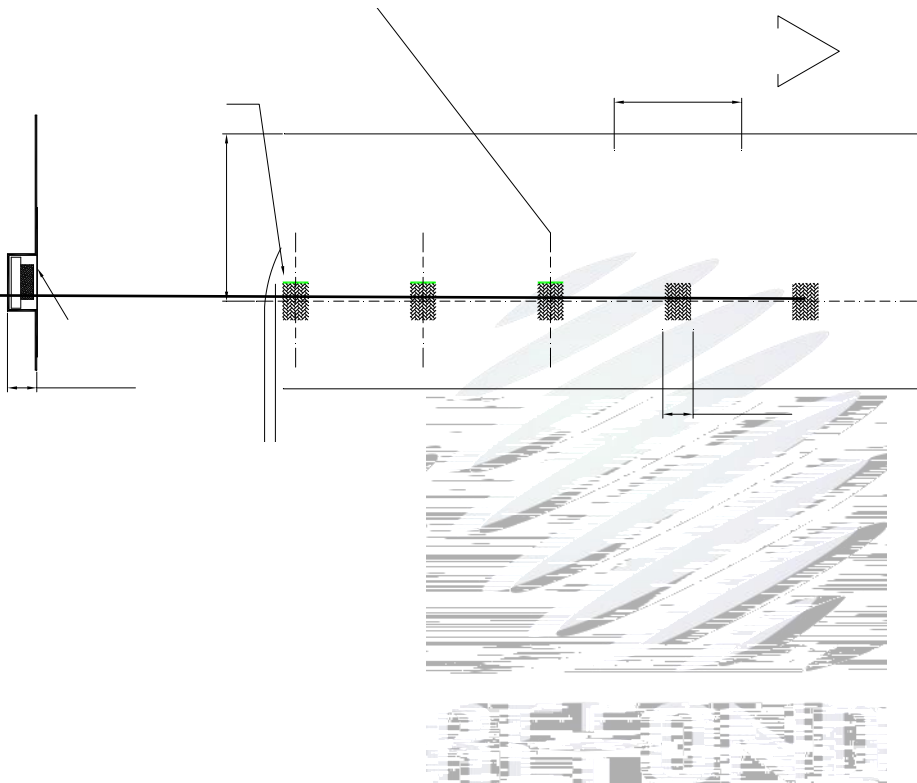
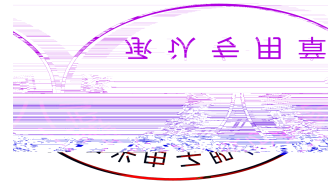

PART NO: .  
 SPEC NO:  
 LOT NO

BIN CODE:  
 Φ: XY:  
 VF: WLD:

QTY:  
 DATE:



---

---

---

---

---

---

---

---

---

---

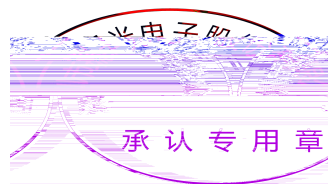
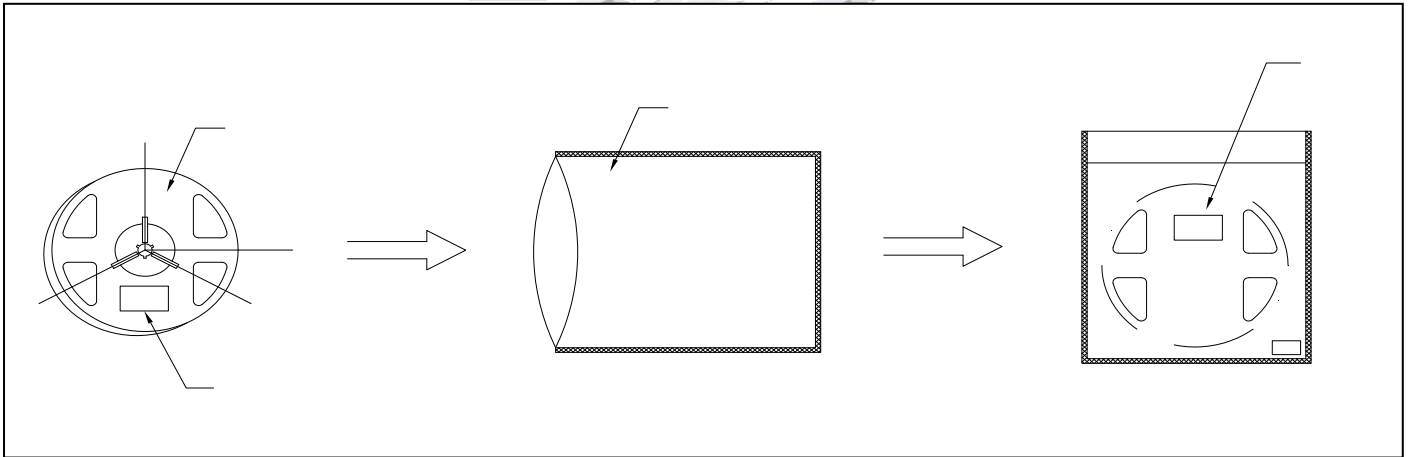



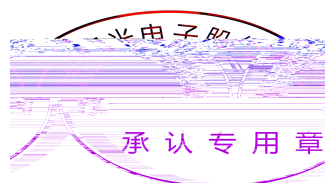
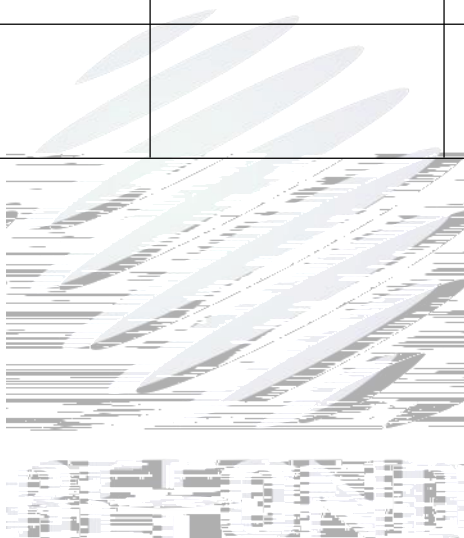

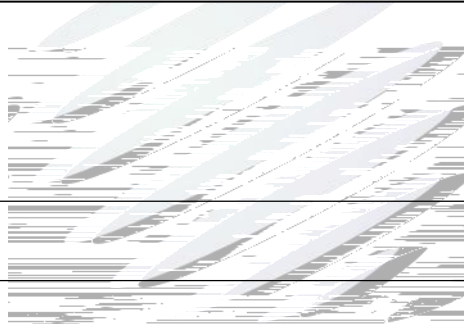
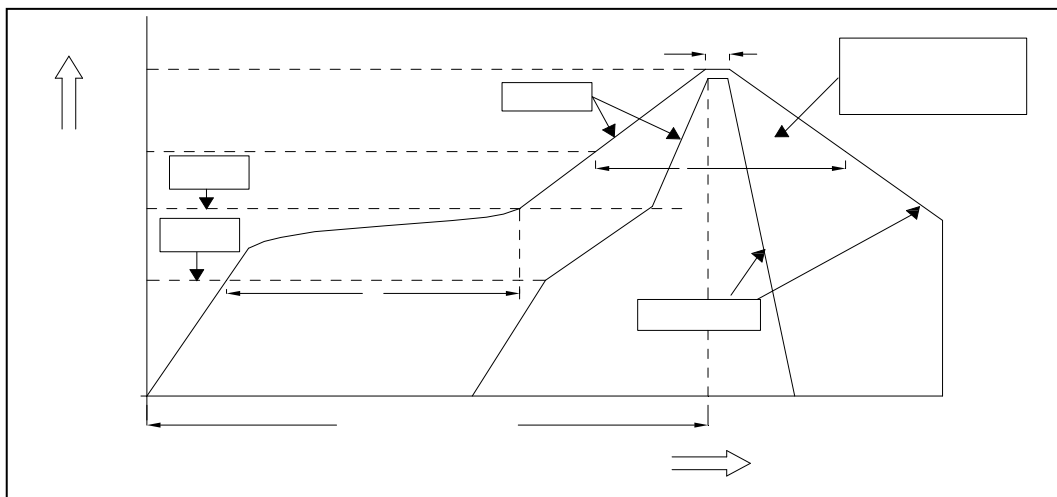

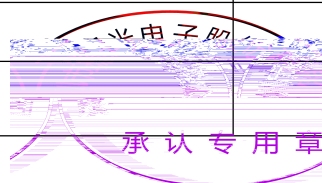



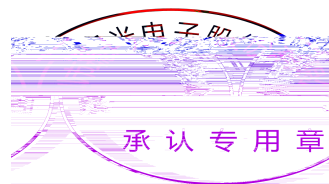

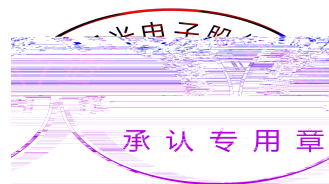





±

