

±

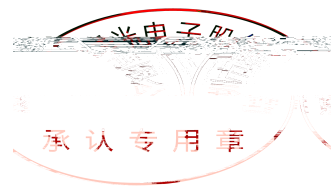

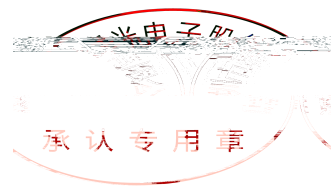

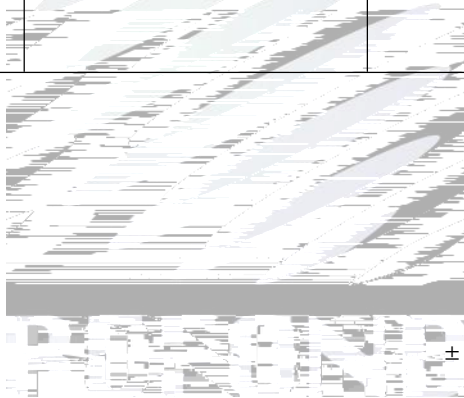

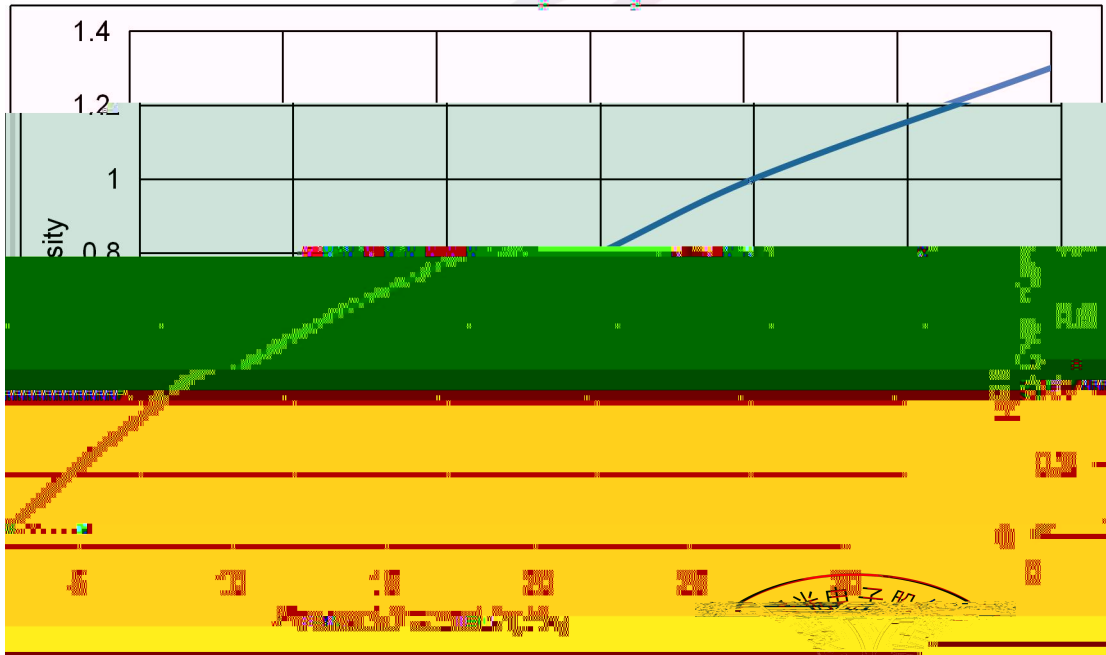
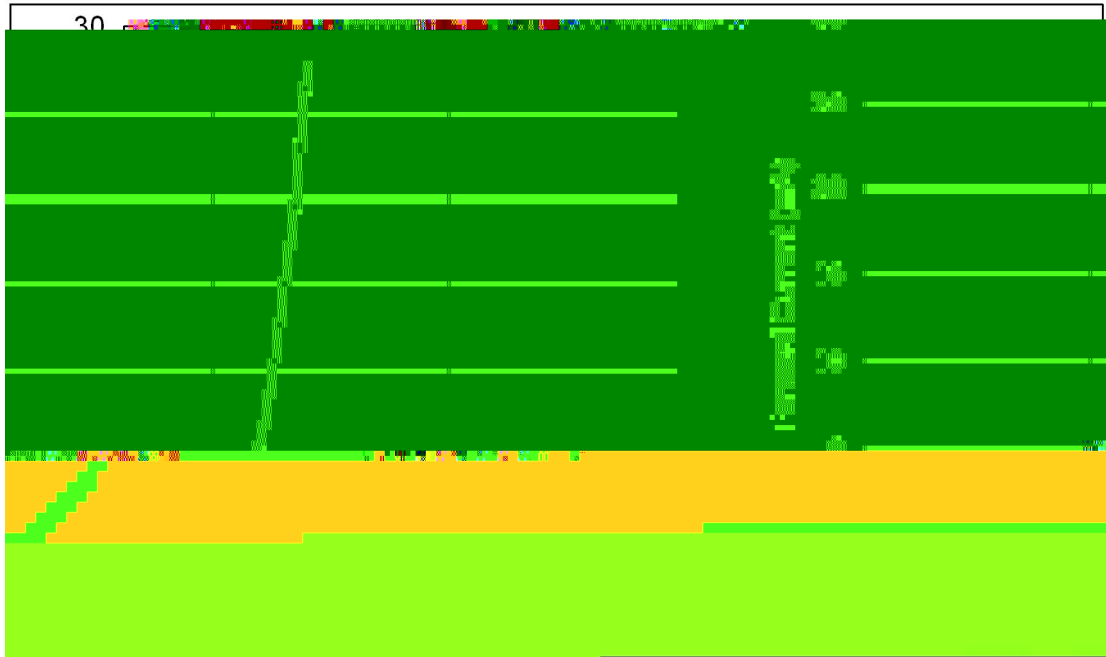

承认专用章

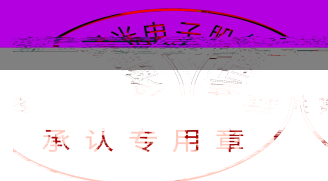
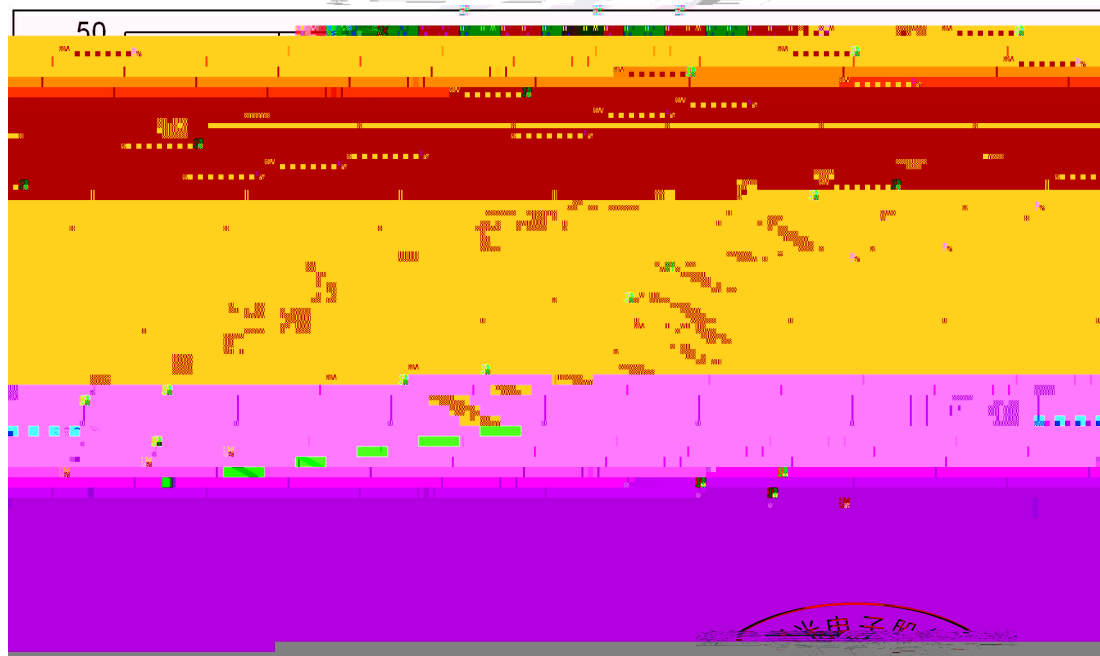
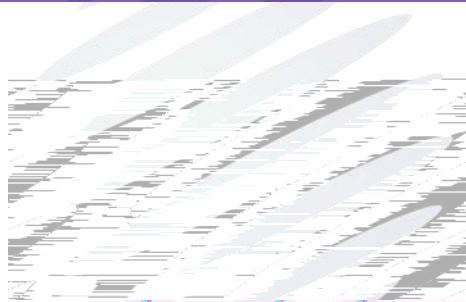
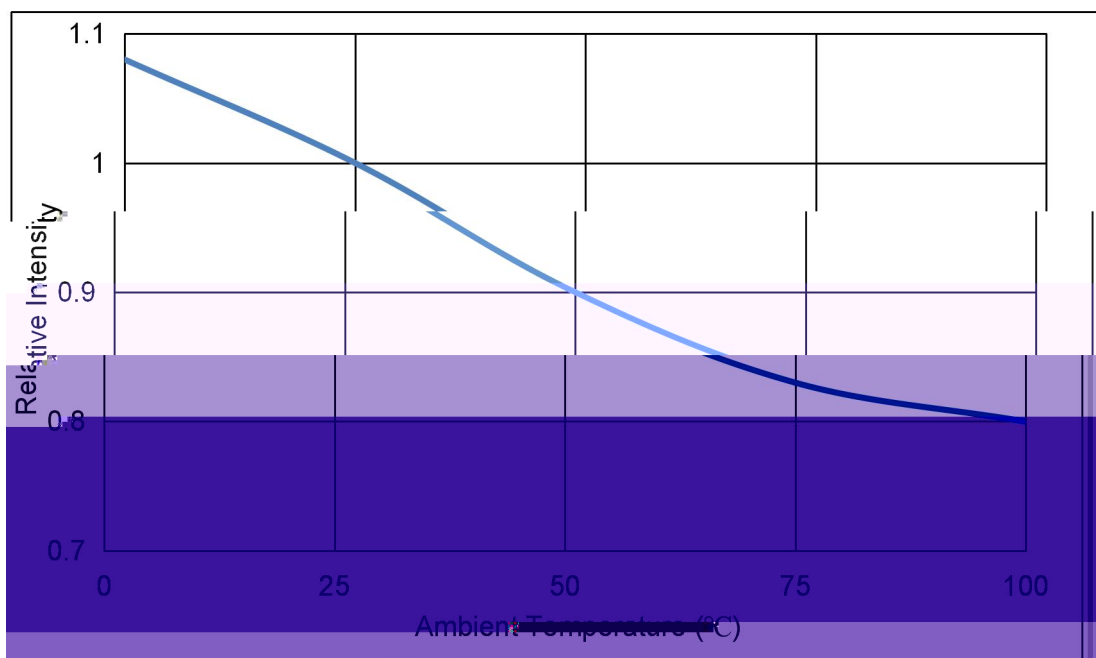

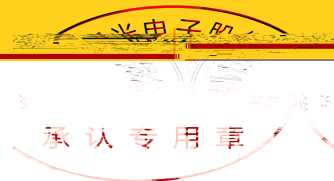
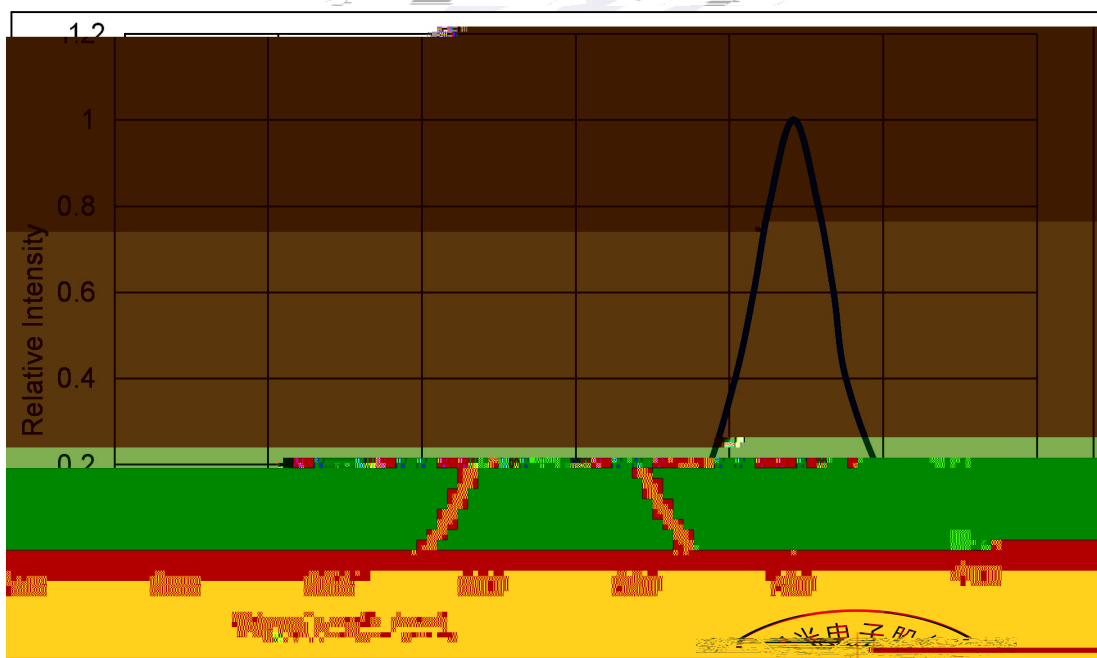
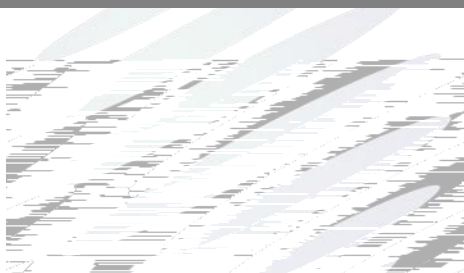
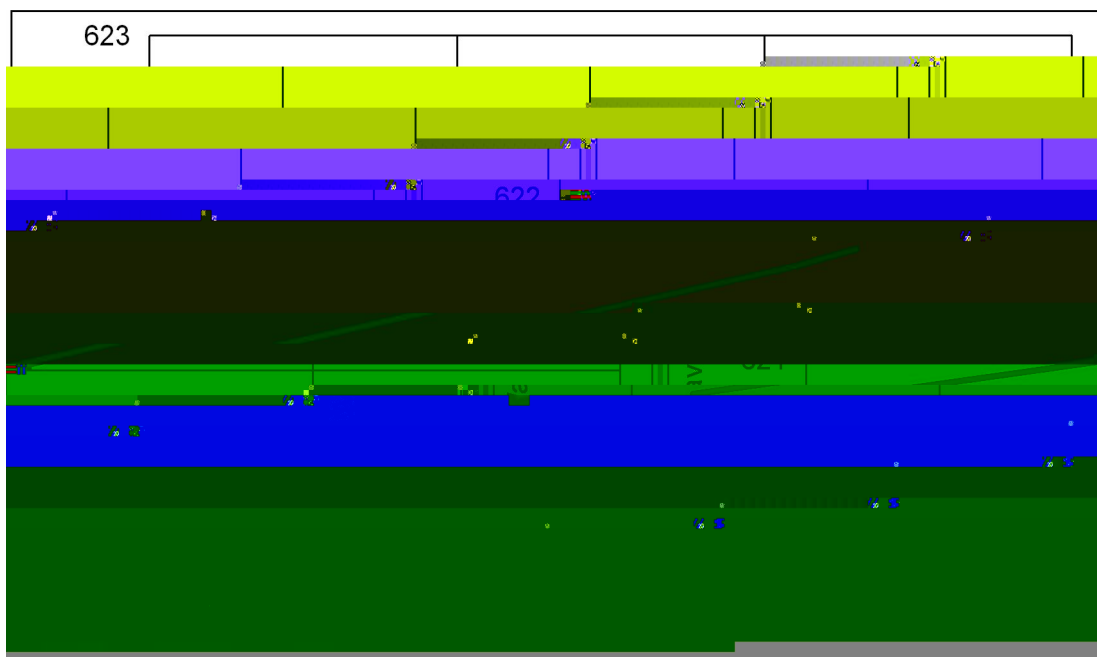

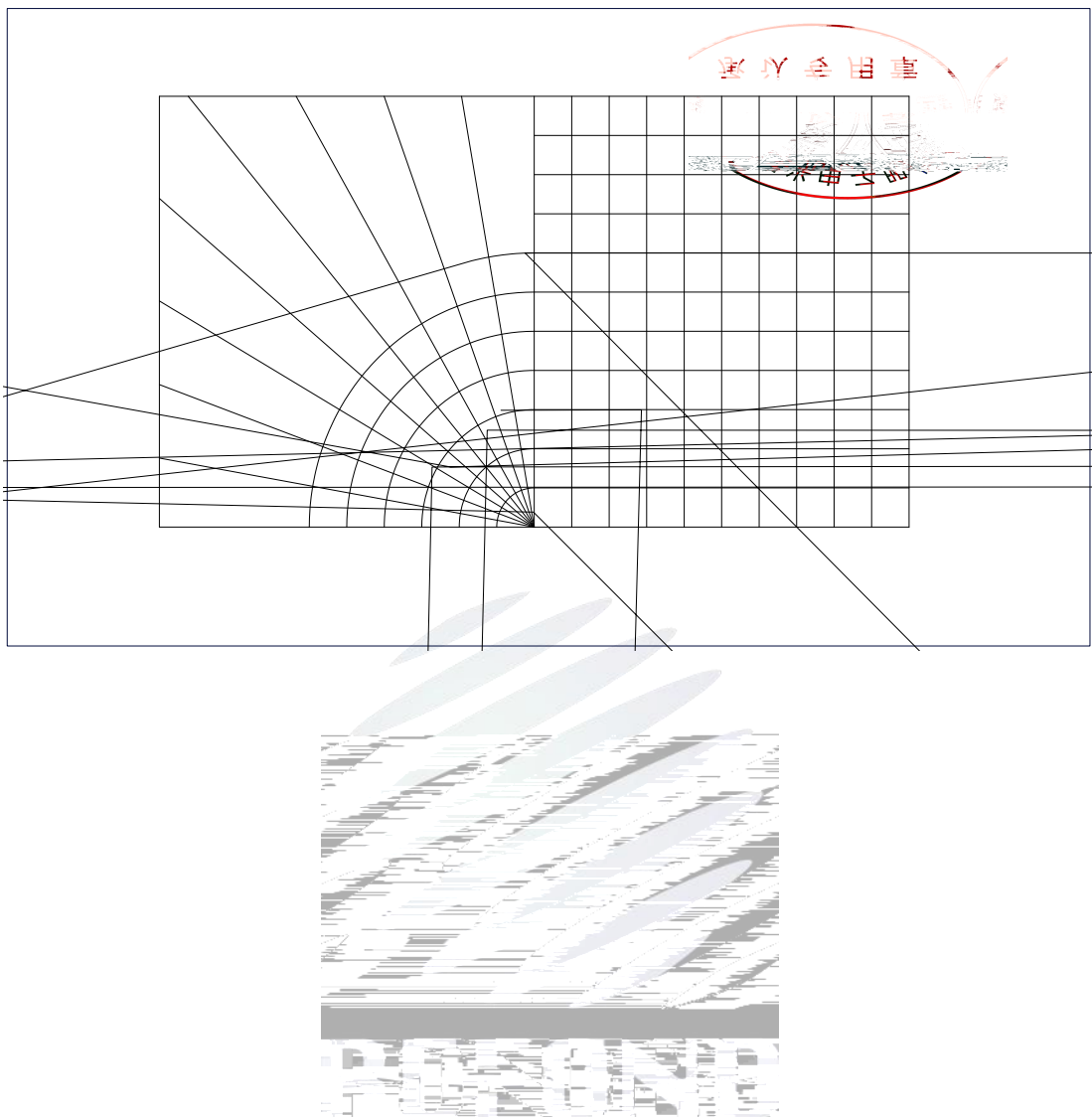

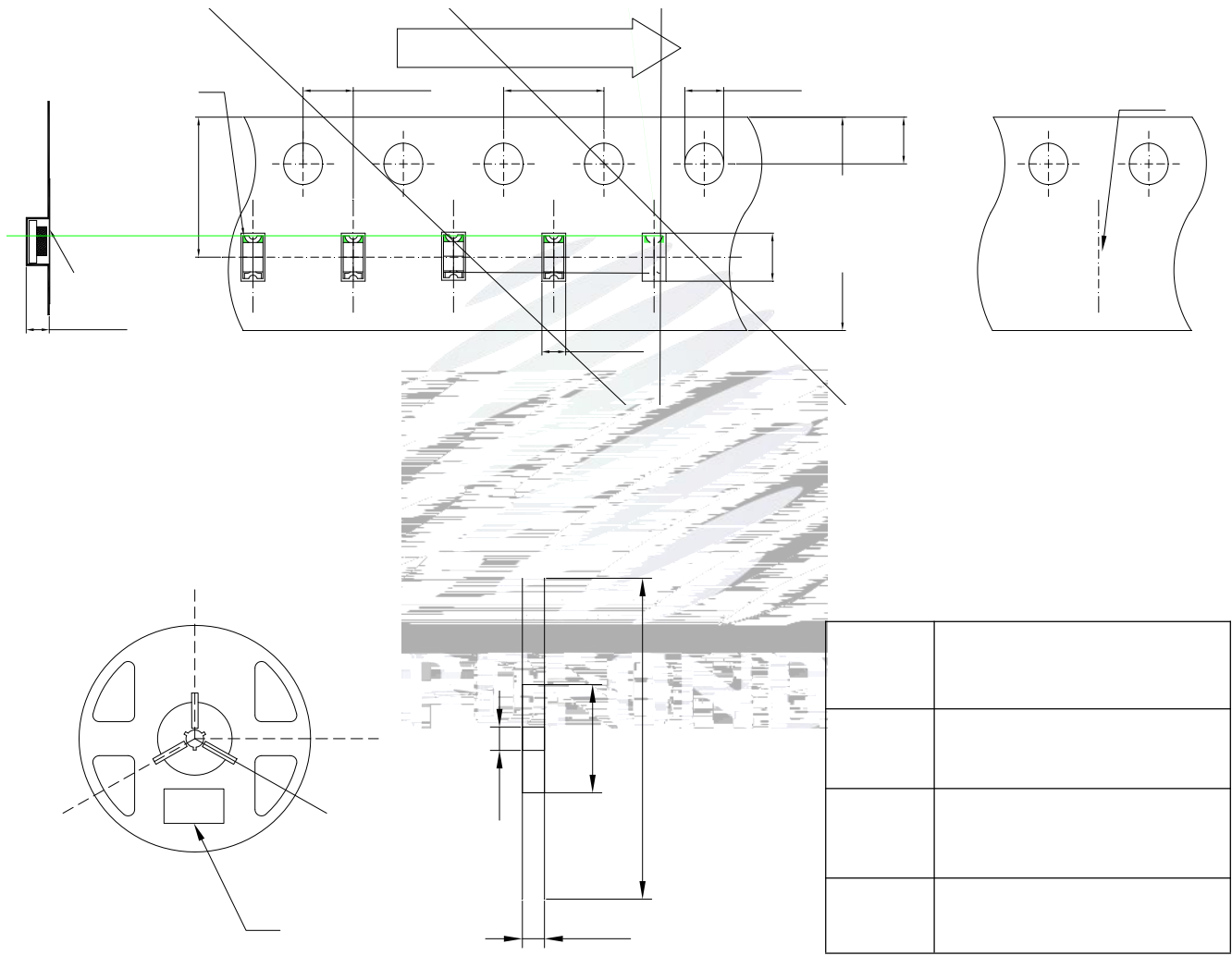



PART NO: .
SPEC NO:
LOT NO



BIN CODE:
Φ: XY:
VF: WLD:



QTY:
DATE:

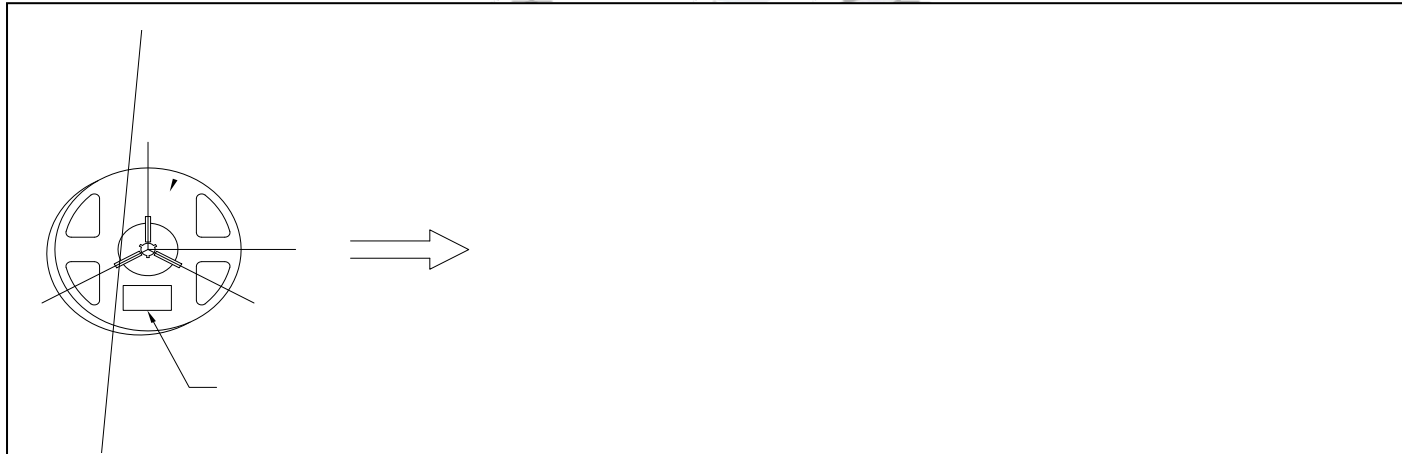

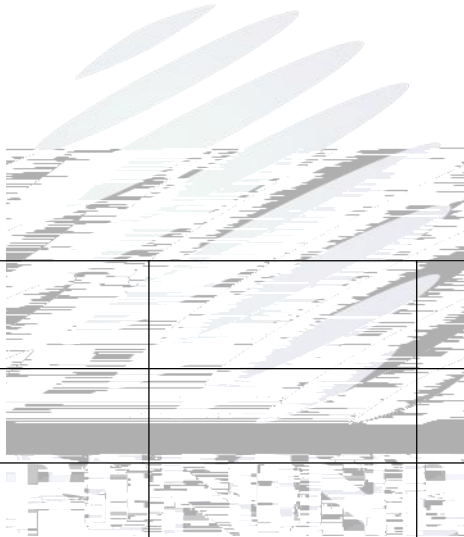
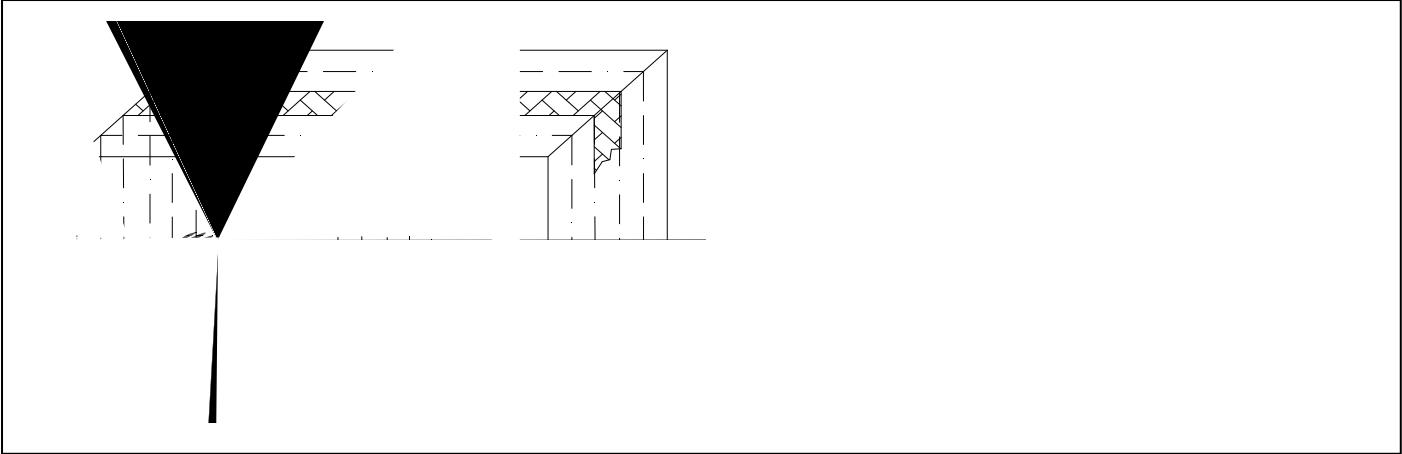

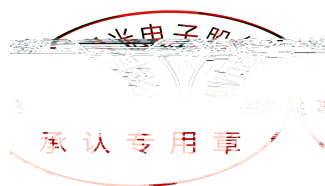
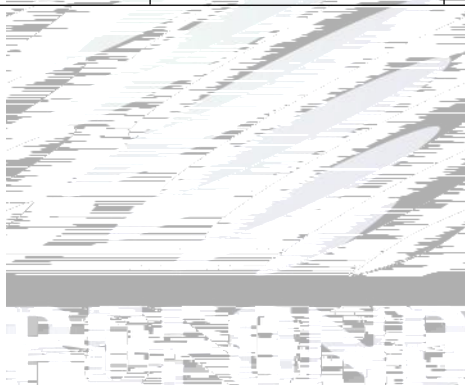

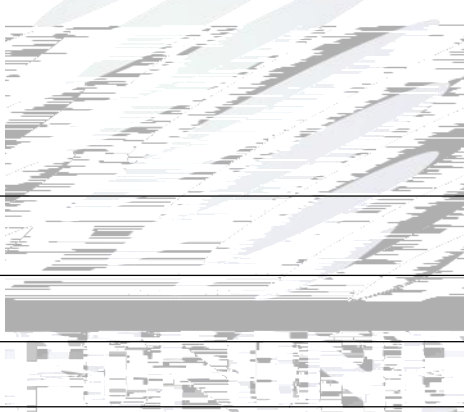
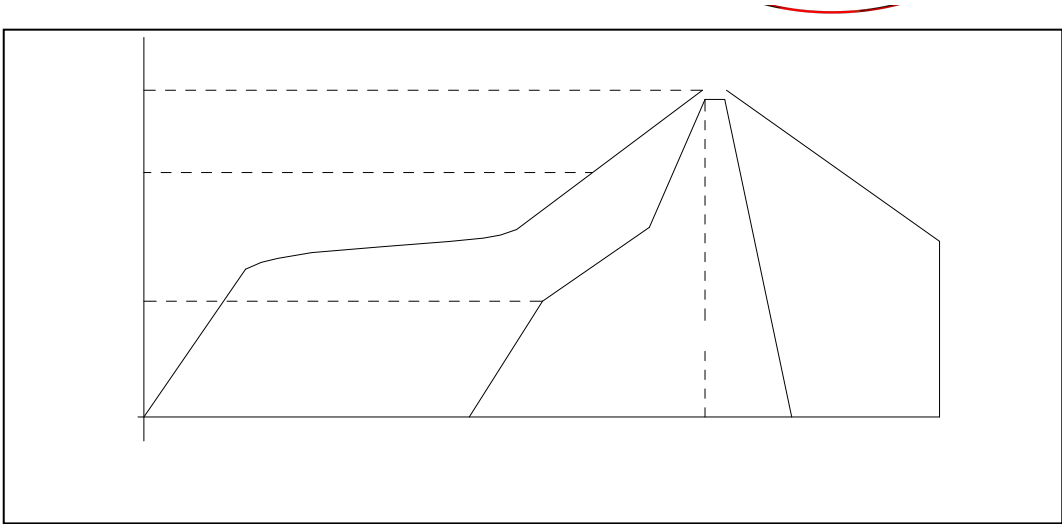

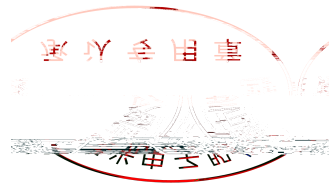

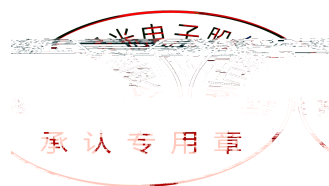

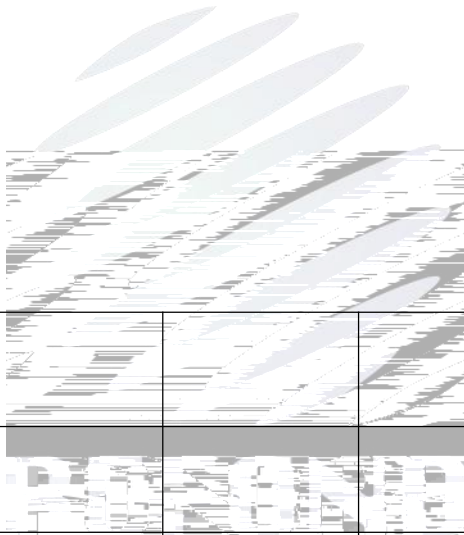

±

