

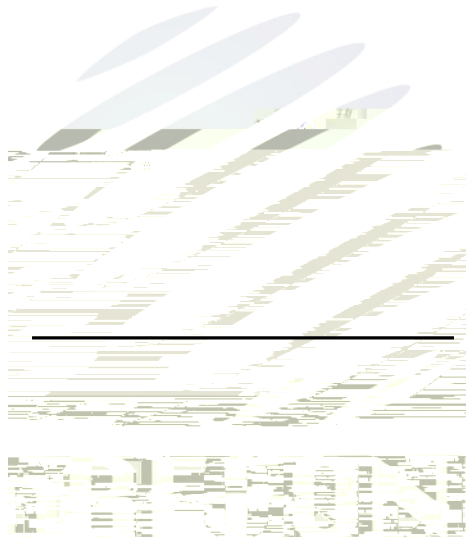

TU
REFOND

瑞登光电





TU
REFOND

瑞登光电

.....	3
.....	3
.....	3
.....	3
.....	4
.....	4
.....	7
.....	10
.....	11
.....	11
.....	11
.....	10
.....	12
.....	13
.....	13
.....	14
.....	15
.....	15
.....	17
.....	17





						mcd
						mcd
						mcd
						mcd
						mcd
						μ



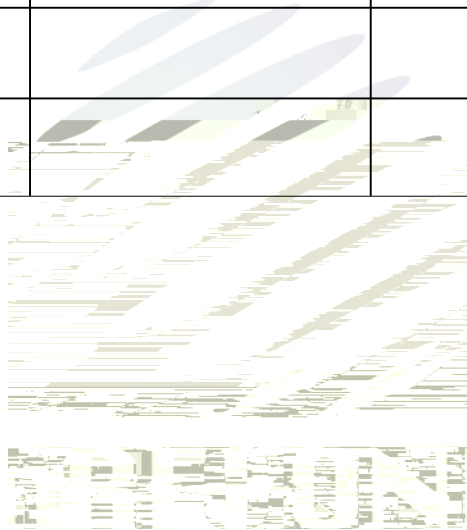

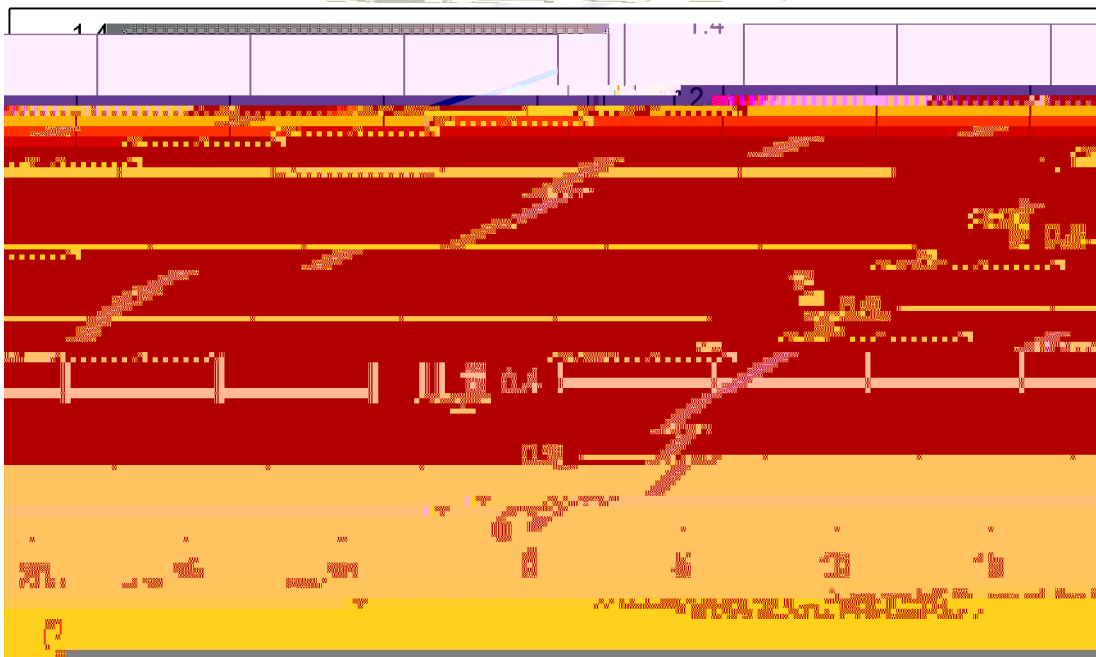
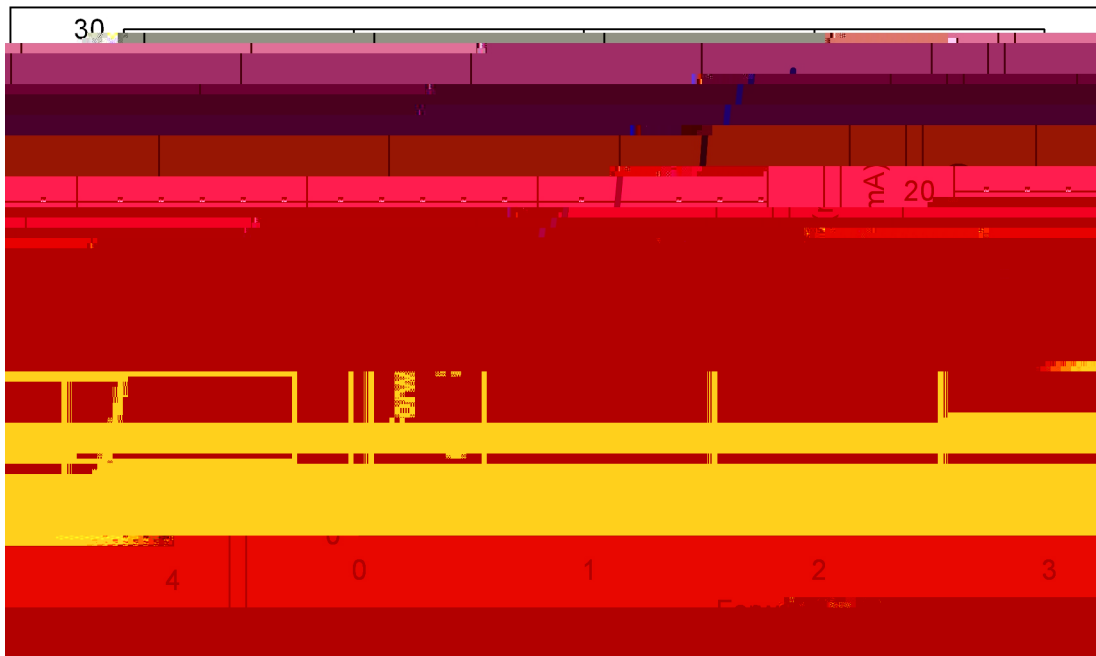

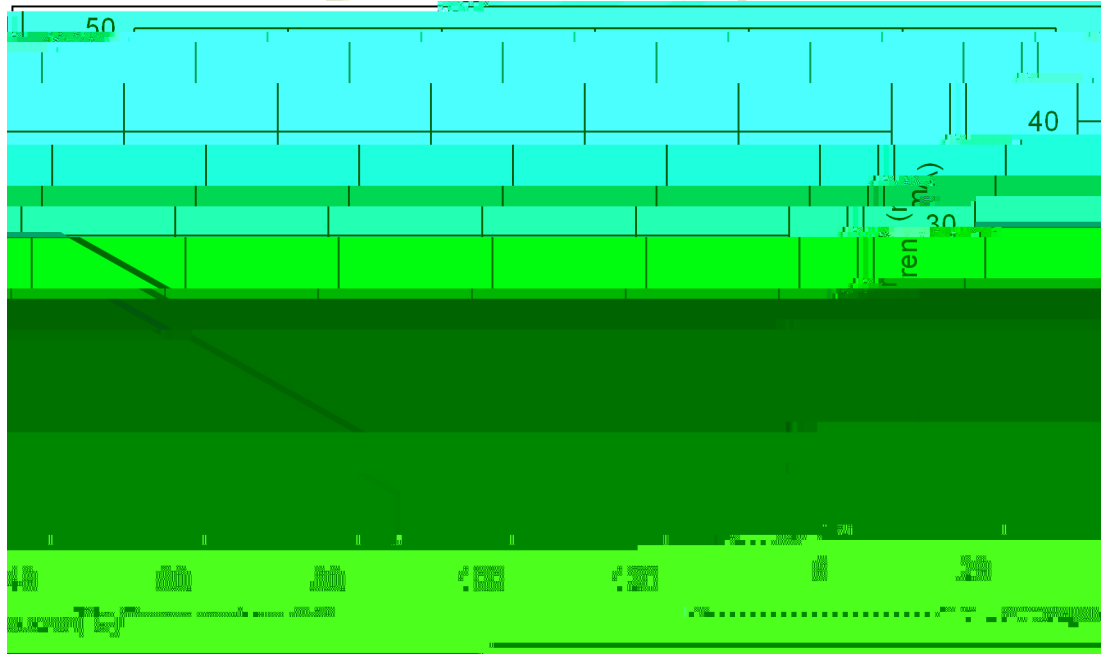
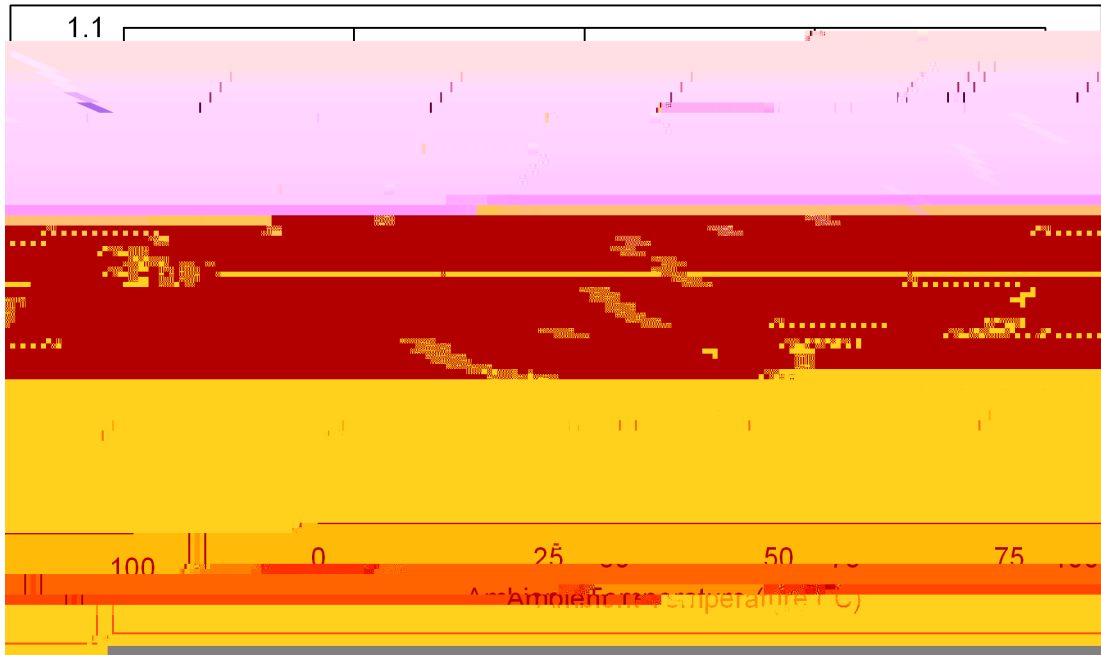
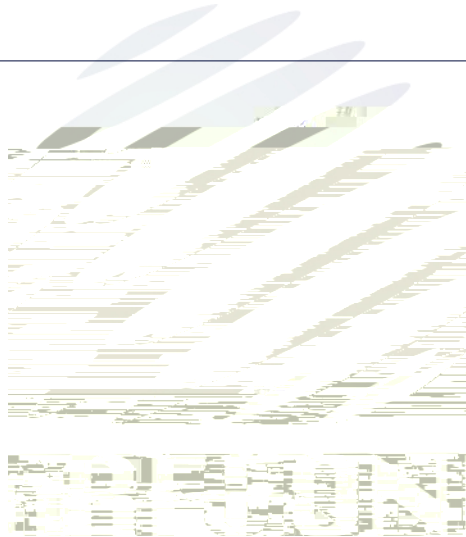
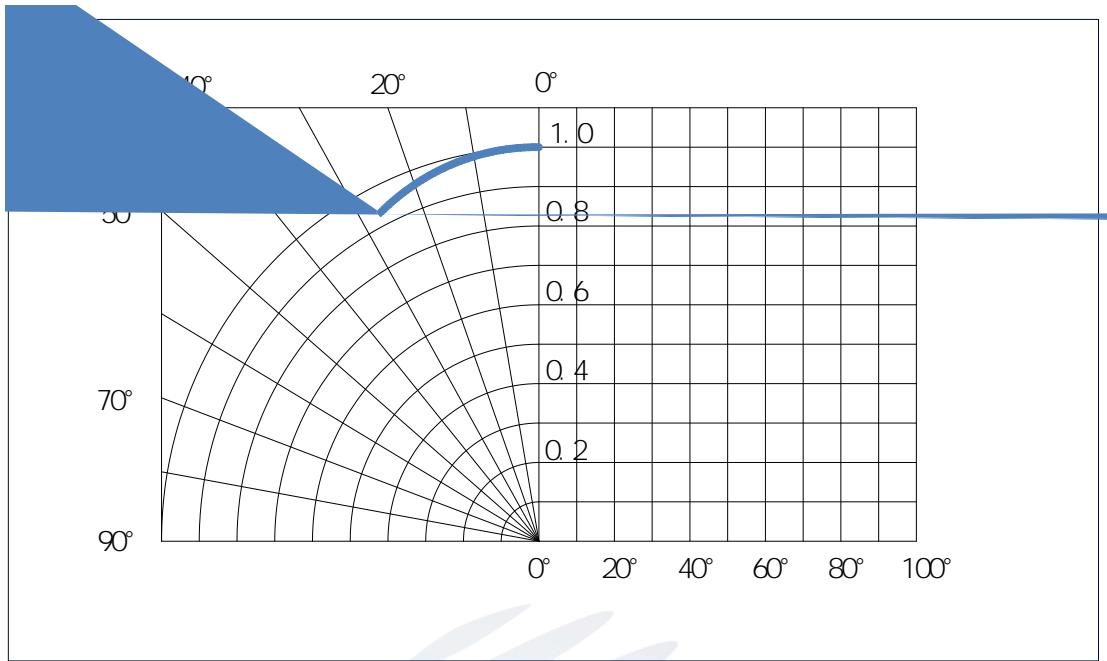



Fig 1-10 Forward Current I_K







PART NO:		
SPEC NO:		LOT NO:
		BIN CODE:
		IV:
		VF:
		
	WLD:	
	Qty:	
	Date:	

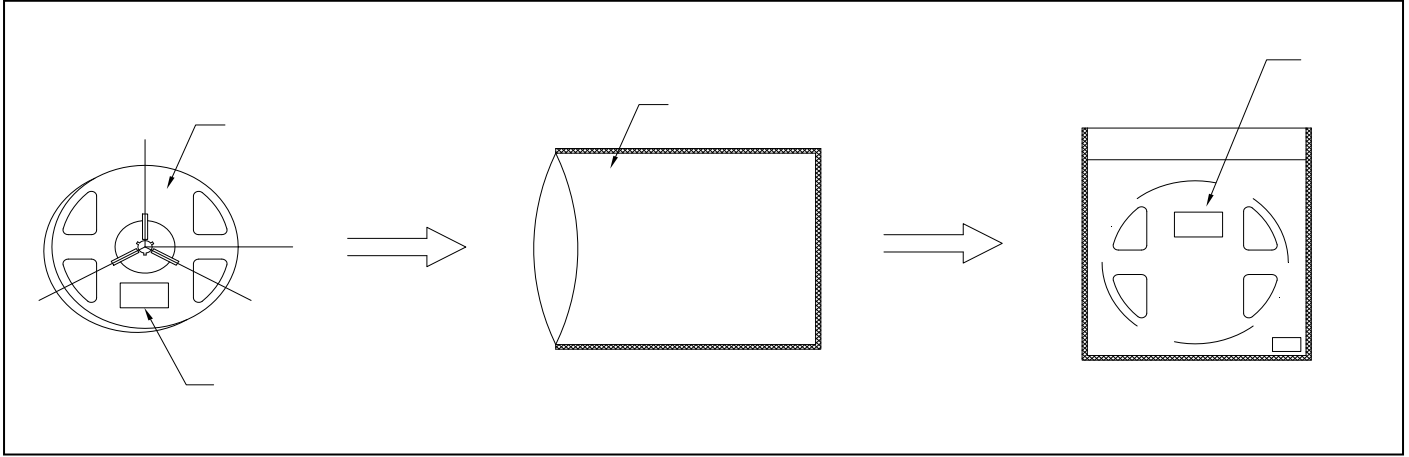

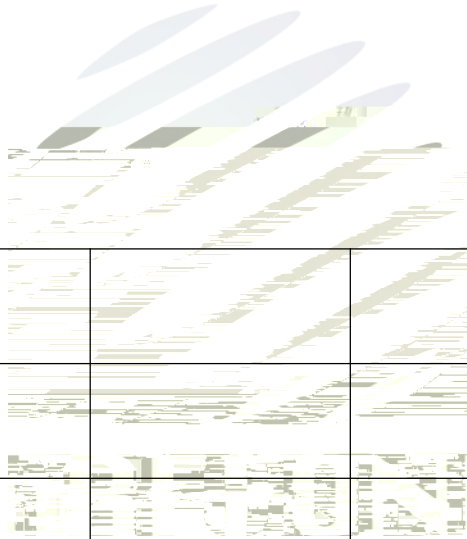
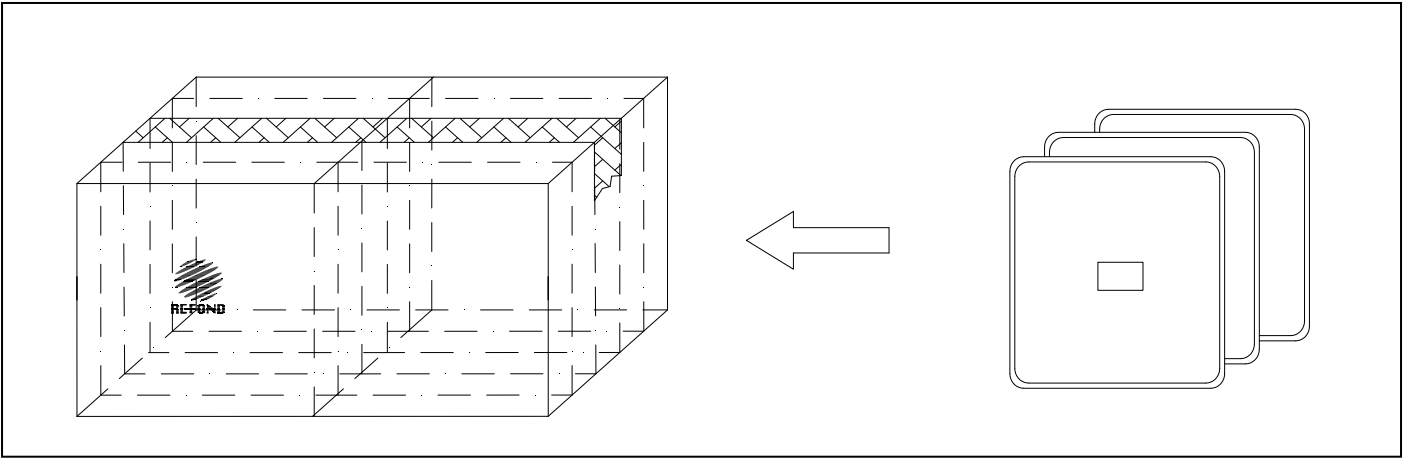



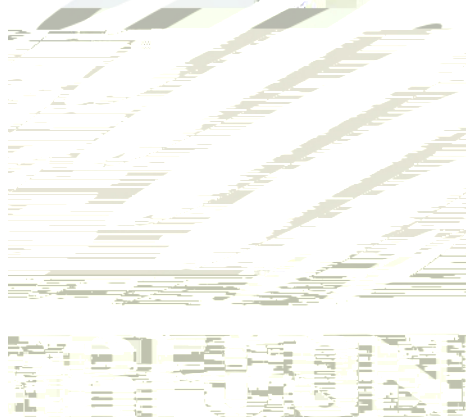

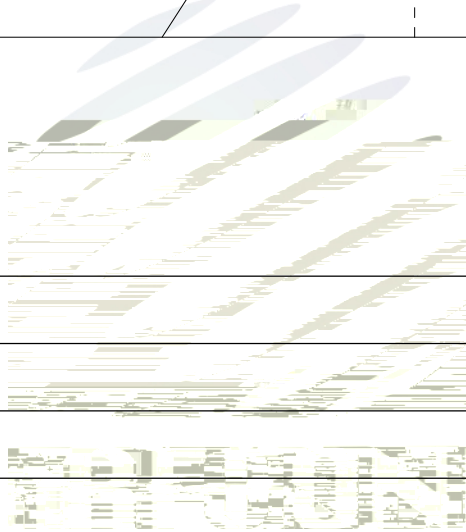
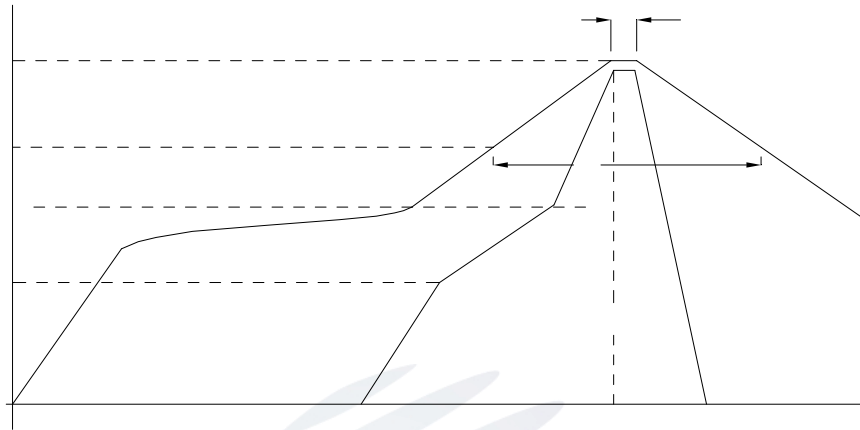



TU
REFOND

瑞登光电





TU
REFOND

瑞登光电





TU
REFOND

瑞登光电

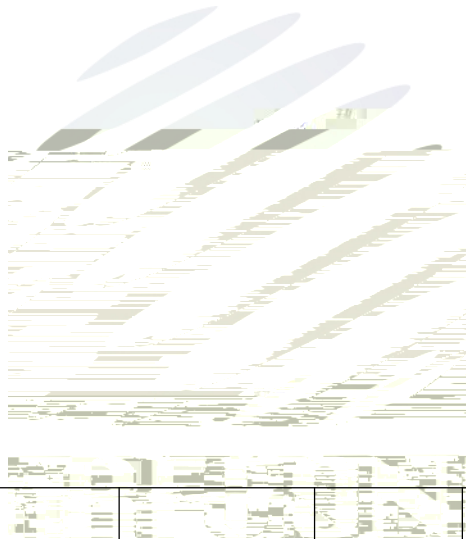



TU
REFOND

瑞登光电



