

SPECIFICATION

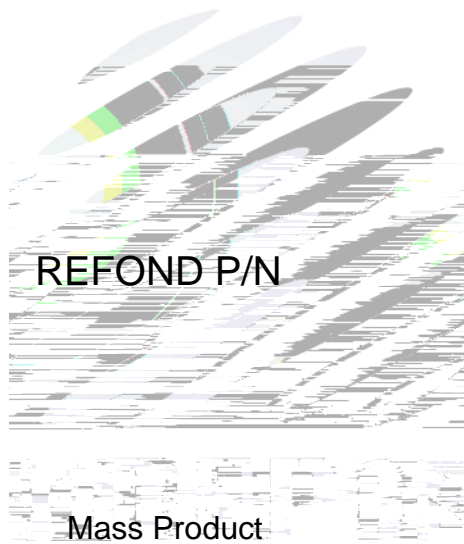

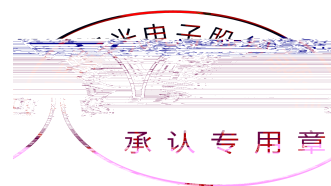
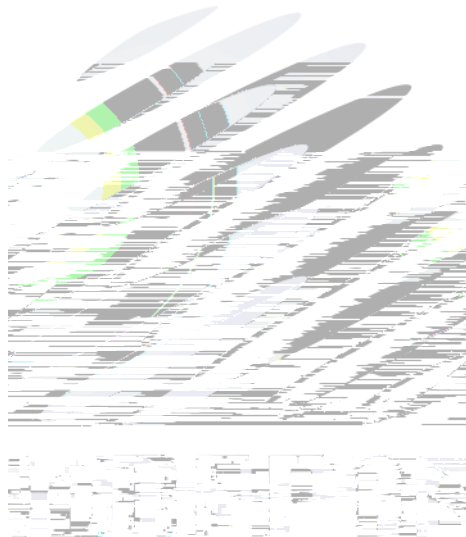

1. Description

1.1 General Description

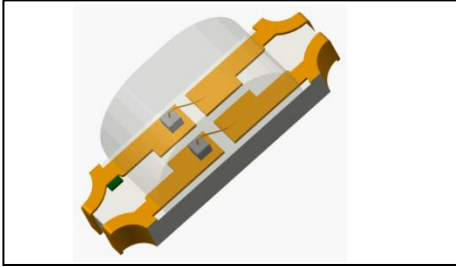

The Colour LED which was fabricated using a yellow chip and a red chip,Package Dimension : 3.2mmX1.0mmX1.48mm.

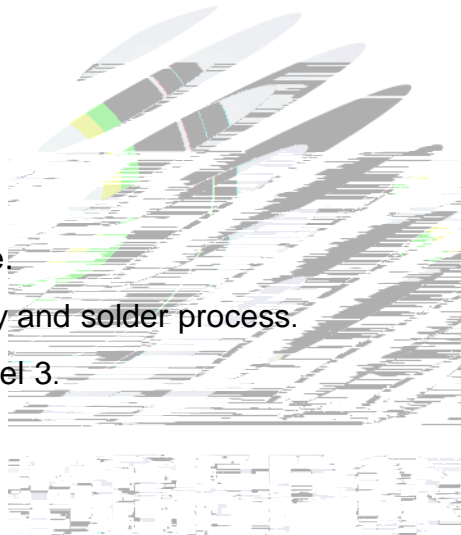

3.2mmX1.0mmX1.48mm

1.2 Features

- Extremely wide viewing angle.
- Suitable for all SMT assembly and solder process.
- Moisture sensitivity level: Level 3.
- RoHS compliant.

1.3 Application

- Optical indicator.
- Switch and symbol, display.
- General use.

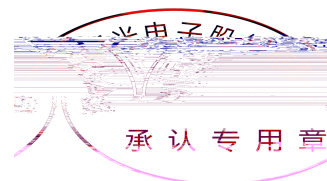

1.4 Package Dimension

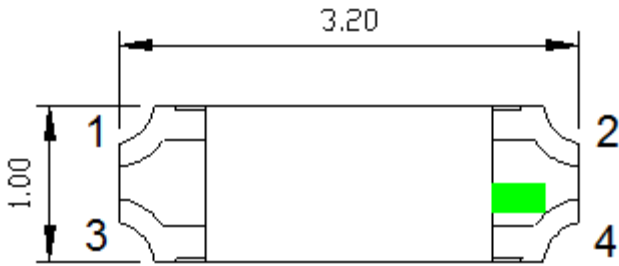

Fig.1-1 Top view

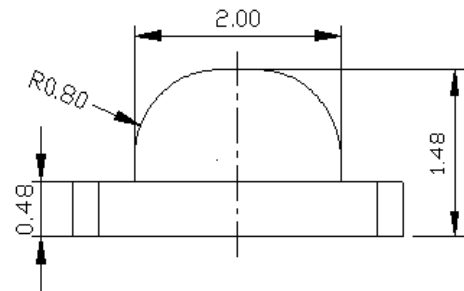

Fig.1-2 Side view

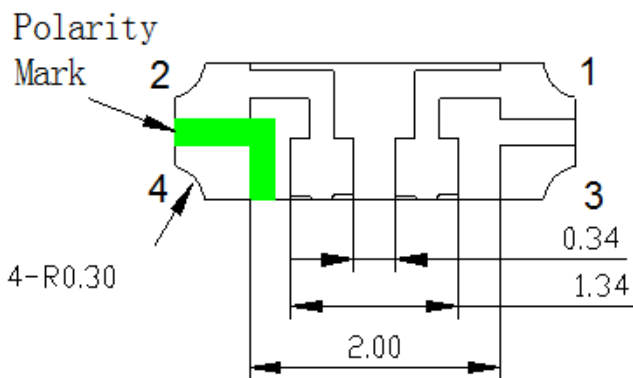

Fig.1-3 Bottom view

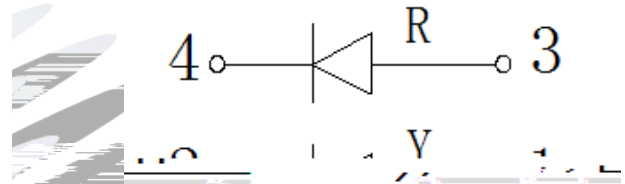

Fig.1-4 Polarity

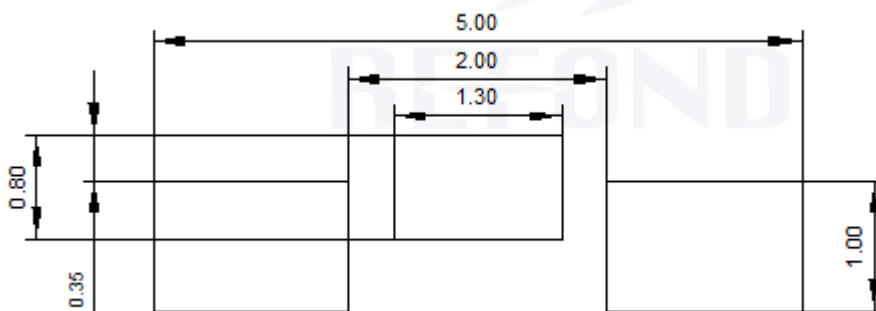
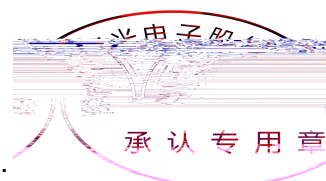

Fig.1-5 Soldering patterns

Notes

All dimensions units are millimeters.

All dimensions tolerances are 0.2mm unless otherwise noted.



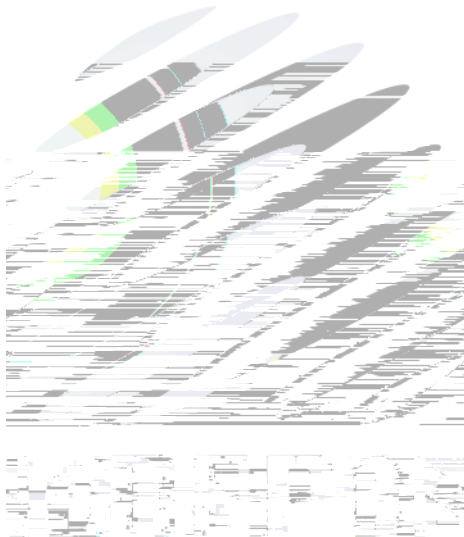
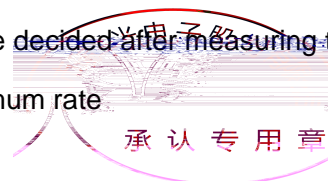

Table 1-2 Absolute Maximum Ratings at Ts=25°C

| Parameter | Symbol | Rating | | Units |
|-------------------------------|-----------|-----------|----|-------|
| | | Y | R | |
| Power Dissipation | P_d | 48 | 48 | mW |
| Forward Current | I_F | 20 | | mA |
| Peak Forward Current Of Pulse | I_{FP} | 60 | | mA |
| Electrostatic Discharge (HBM) | E_{SD} | 2000 | | V |
| Operating Temperature | T_{opr} | -40 ~ +85 | | °C |
| Storage Temperature | T_{stg} | -40 ~ +85 | | °C |
| Junction Temperature | T_j | 95 | | °C |

Notes

- 1/10 Duty cycle, 0.1ms pulse width.
- The above forward voltage measurement allowance tolerance is $\pm 0.1V$.
- The above dominant wavelength measurement allowance tolerance is $\pm 2nm$.
- The above luminous intensity measurement allowance tolerance $\pm 10\%$.
- Care is to be taken that power dissipation does not exceed the absolute maximum rating of the product.
- All measurements were made under the standardized environment of Refond.
- When the LEDs are in operation the maximum current should be decided after measuring the package temperature, junction temperature should not exceed the maximum rate.



1.6 Typical Optical Character

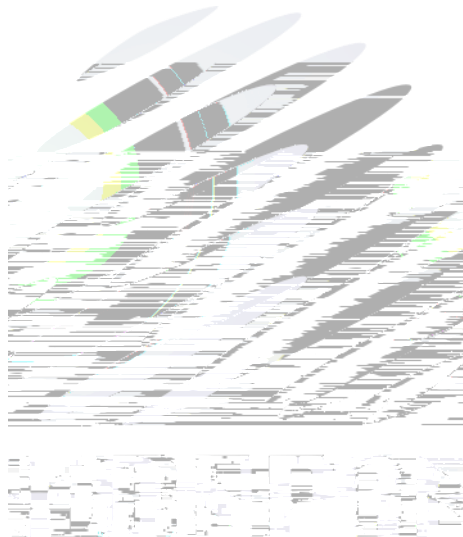

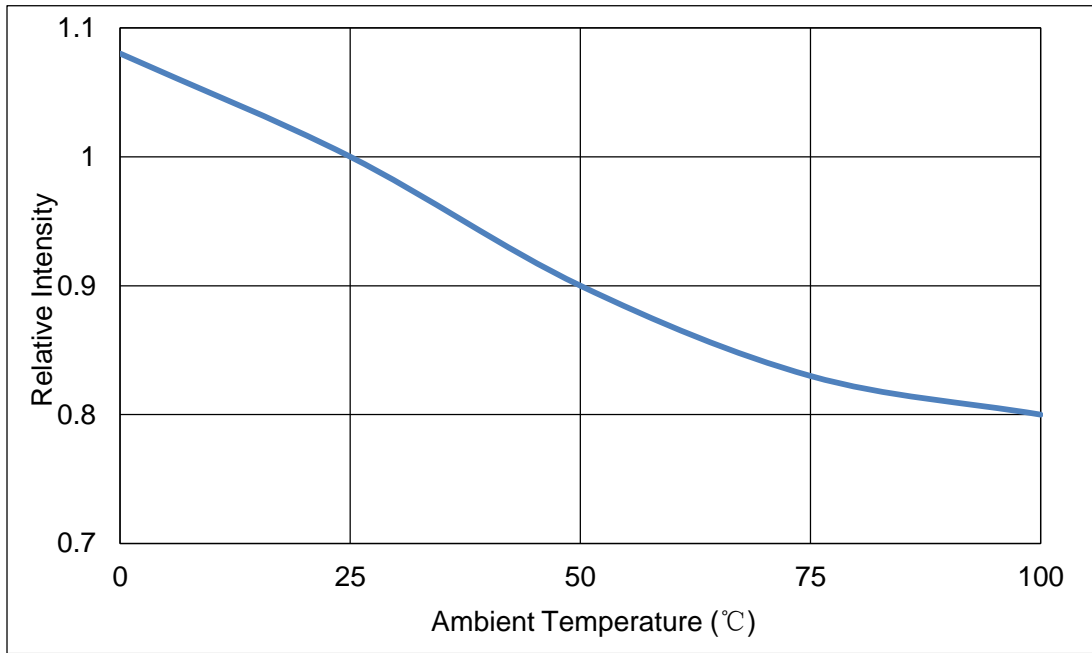

Fig.1-8 Pin Temperature Vs Relative Intensity

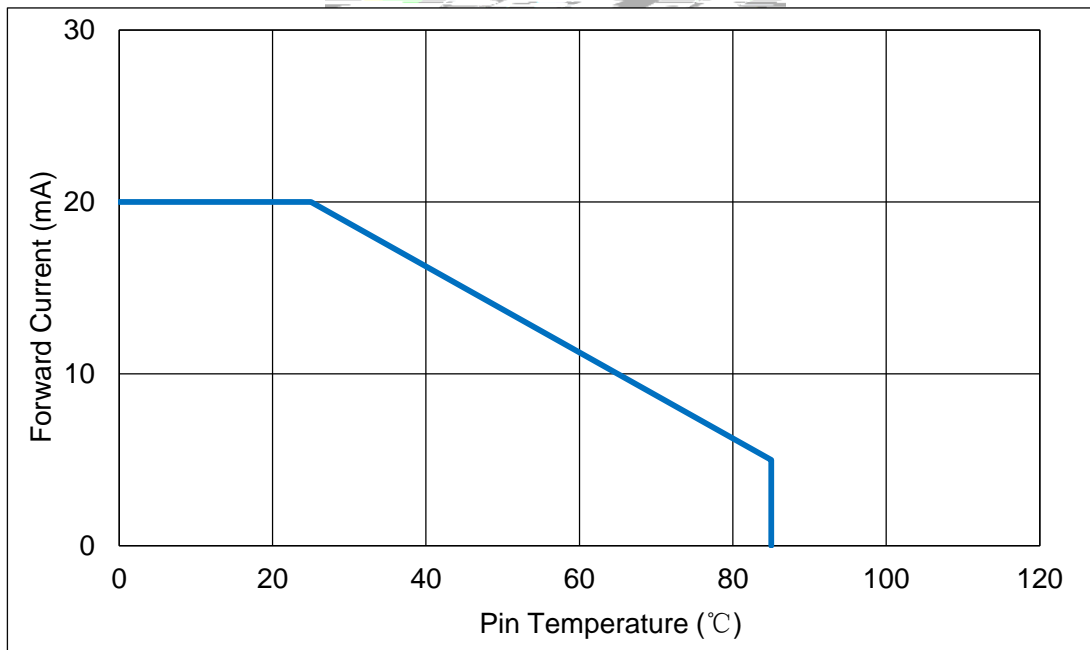
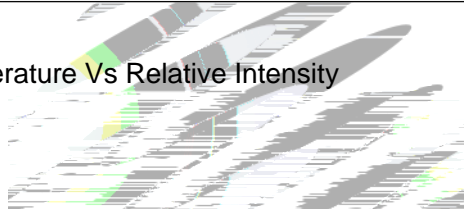

Fig.1-9 Pin Temperature Vs Forward Current



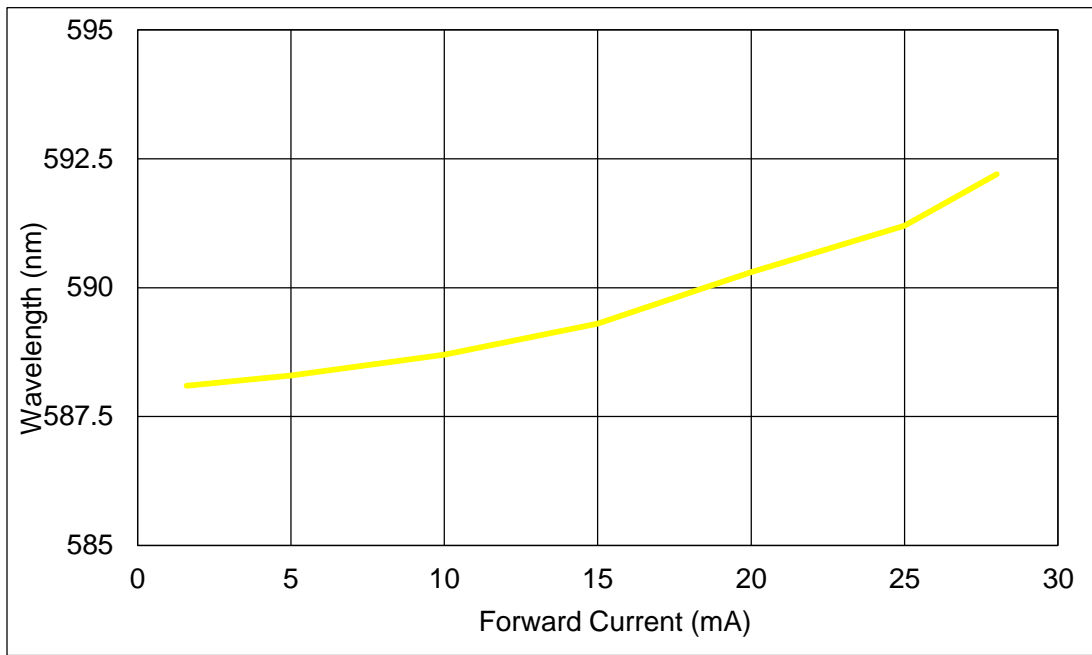

Fig.1-10 Forward Current Vs Dominate Wavelength (Ta=25)

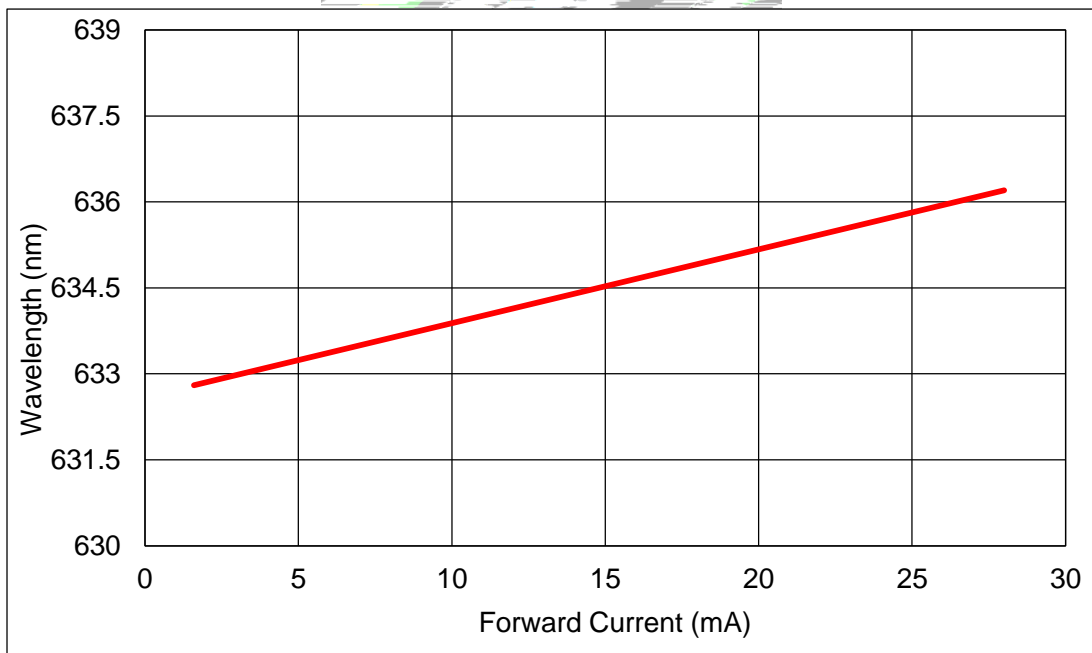
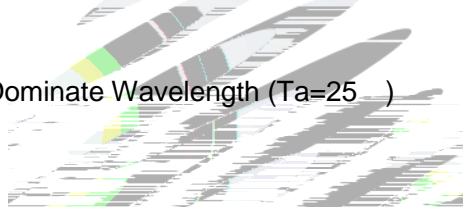
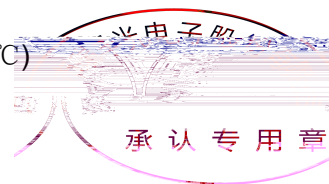

Fig.1-11 Forward Current Vs Dominate Wavelength (Ta=25°C)



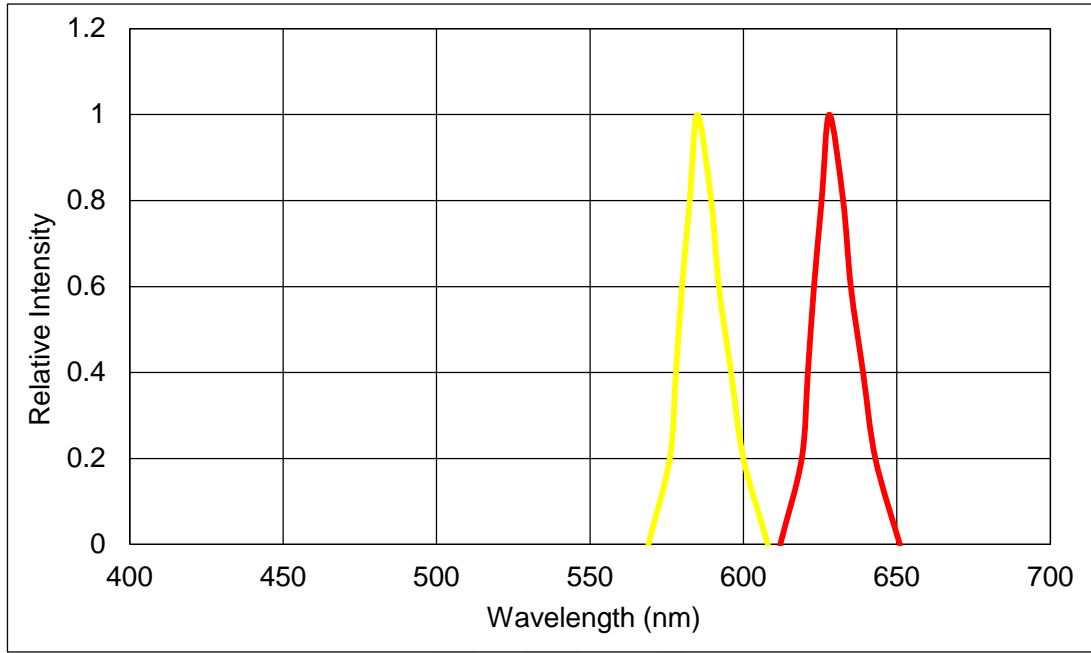

Fig.1-12 Relative Intensity Vs Wavelength (Ta=25°C)

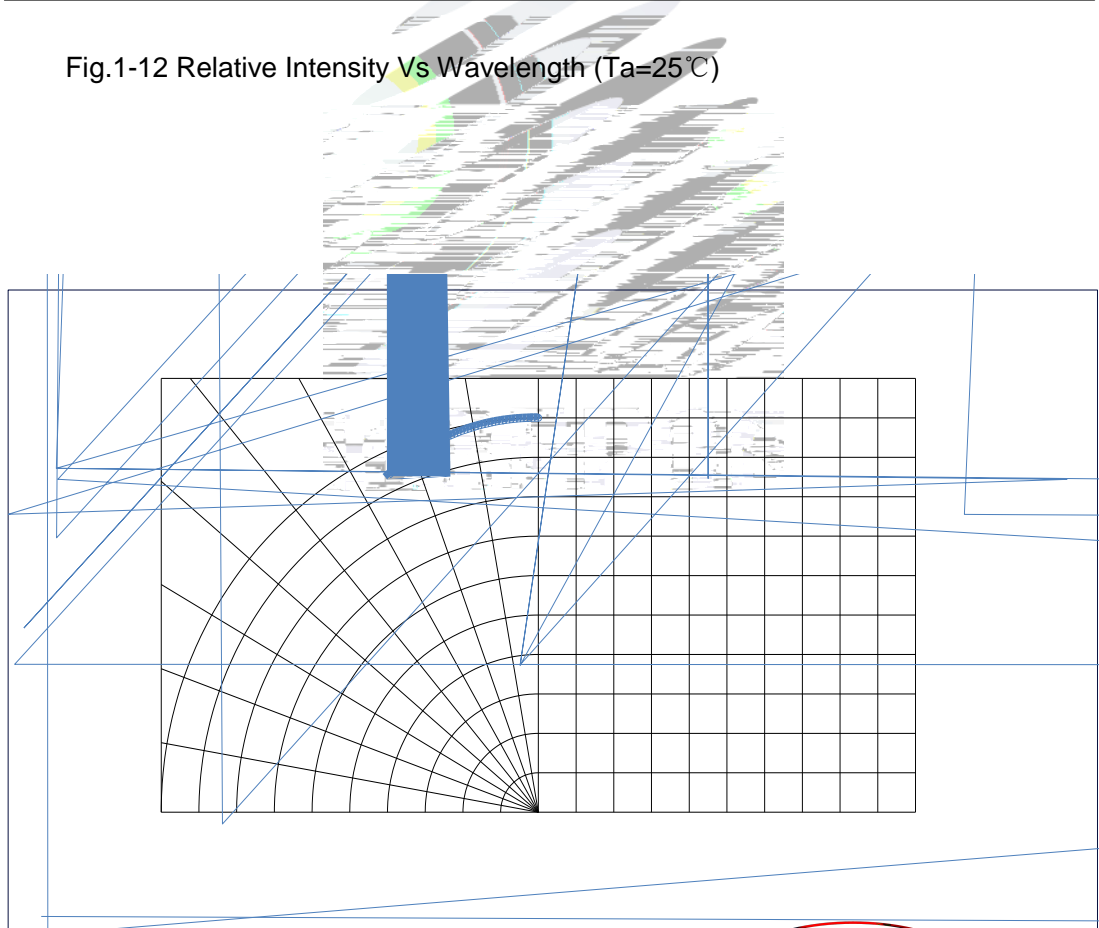
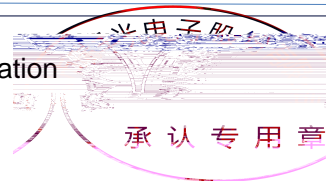

Fig.1-13 Diagram characteristics of radiation



2. Packaging

2.1 Packaging Specification

Package: 3000pcs/reel. 3000pcs

2.1.1 Carrier Tape Dimension

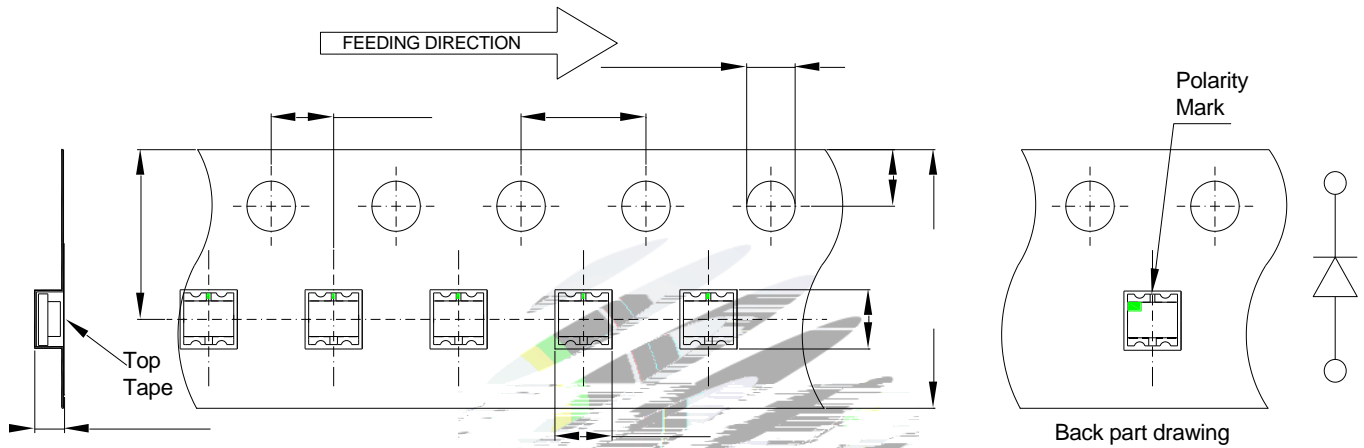

Fig.2-1 Carrier Tape Dimension

2.1.2 Reel Dimension

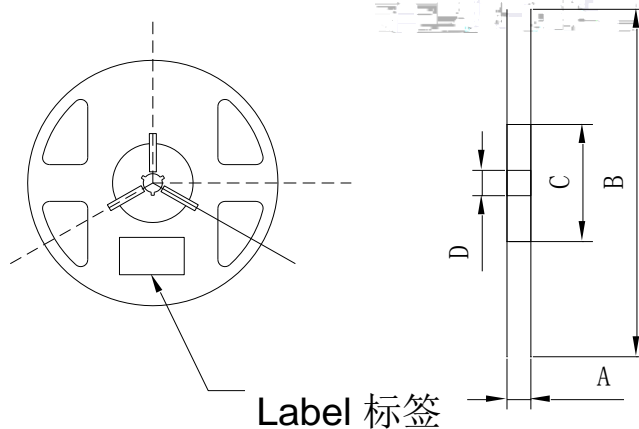

Fig.2-2 Reel Dimension

Table 2-1 Dimension

| | |
|---|------------|
| A | 8.0 0.1mm |
| B | 178 1mm |
| C | 60 1mm |
| D | 13.0 0.5mm |

Notes

The tolerances unless mentioned $\pm 0.1\text{mm}$. Unit : mm

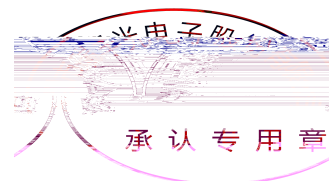

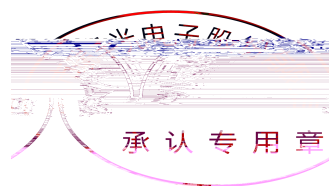
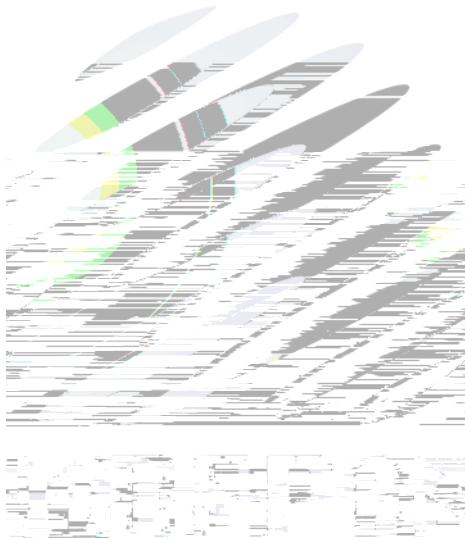

2.3 Cardboard Box

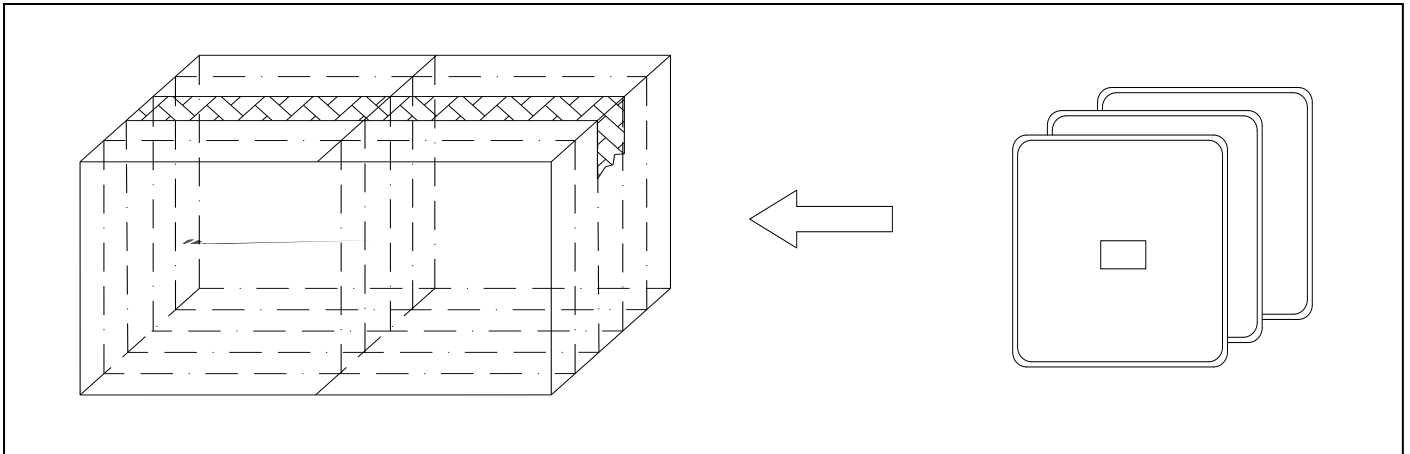
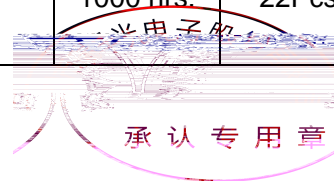

Fig.2-5 Cardboard Box

2.4 Reliability Test Items And Conditions

Table 2-3 Reliability Test Items And Conditions

| Test Items | Ref.Standard | Test Condition | Time | Quantity | Ac/Re / |
|--------------------------|--------------|--|------------|----------|---------|
| Reflow | JESD22-B106 | Temp:260 max T=10 sec | 2 times | 22Pcs. | 0/1 |
| Temperature Cycle | JESD22-A104 | 100 30 min 5 min -40 30 min | 100 cycles | 22Pcs. | 0/1 |
| Thermal Shock | JESD22-A106 | -40 15min 100 15min | 300 cycles | 22Pcs. | 0/1 |
| High Temperature Storage | JESD22-A103 | Temp:100 | 1000 hrs. | 22Pcs. | 0/1 |
| Low Temperature Storage | JESD22-A119 | Temp:-40 | 1000 hrs. | 22Pcs. | 0/1 |
| Life Test | JESD22-A108 | T _a =25 I _F =20mA | 1000 hrs. | 22Pcs. | 0/1 |



2.5 Criteria For Judging Damage

Table 2-4 Criteria For Judging Damage

| Test Items | Symbol | Test Condition | Criteria For Judgement | |
|-----------------|--------|-------------------|------------------------|-------------|
| | | | Min. | Max. |
| Forward Voltage | V_F | $I_F=20\text{mA}$ | - | U.S.L*)x1.1 |
| Reverse Current | I_R | $V_R= 5\text{V}$ | - | U.S.L*)x2.0 |
| Luminous Flux | | $I_F=20\text{mA}$ | L.S.L*)x0.7 | - |

Notes

1.U.S.L: Upper standard level

L.S.L: Lower standard level

2.The above reliability tests is based on the verification of a single/strip LED of Refond's existing experimental platform,the reliability experiment was taken under good heat dissipation conditions. When customers applies the LED to the series and parallel circuit,should take consideration of all the factors such as the current, voltage distribution, heat dissipation and others.

3.The technical information shown in the data sheets is limited to the typical characteristics and circuit examples of the referenced products. It does not constitute the warranting of industrial property nor the granting of any license.

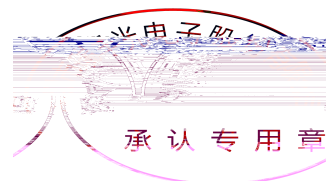

3. SMT Reflow Soldering Instructions SMT

3.1 SMT Reflow Soldering Instructions SMT

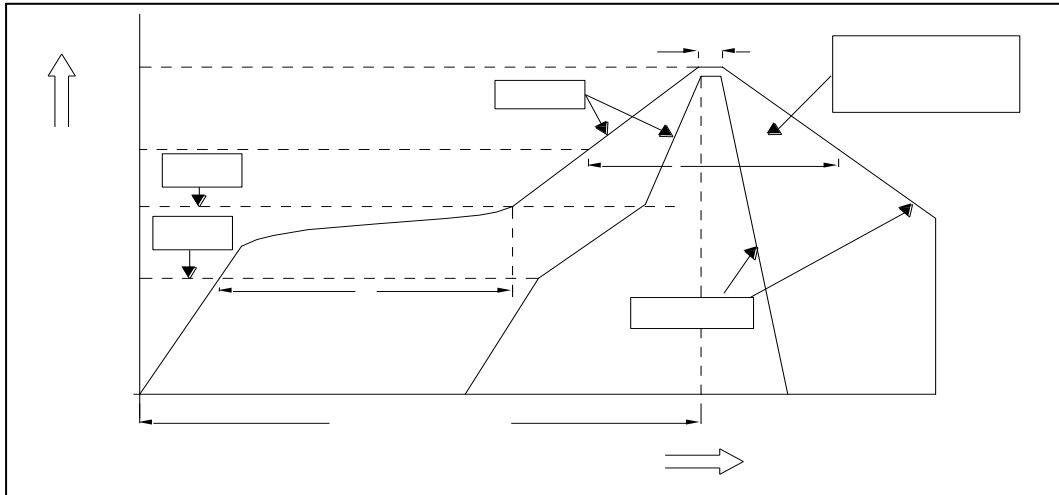
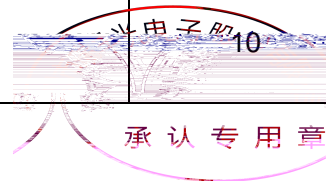

Fig.3-1 SMT Reflow Soldering Instructions SMT

Table 3-1 Parameters

| | | |
|--|-----------------------|-------------------|
| Average temperature rise speed | T_{smax} T_P | 3 °C/ Max 3 °C/ s |
| Preheating: minimum temperature | (T_{smin}) | 150 °C |
| Preheating: Max temperature | (T_{smax}) | 200 °C |
| Preheating: Time | T_{smin} T_{smax} | 60 - 120 60s-120s |
| Time limited to maintain high temperature: the temperature | (T_L) | 217 °C |
| Time limited to maintain high temperature: The Time | (t_L) | 60 Max 60s |
| Peak /Classification of temperature: | / (T_P) | 260 °C |
| Time limit classification of peak temperature time | t_p | Max 10s |



承认专用章

| | | | | |
|-------------------|--|------------------|-------|---------------|
| (T _P) | 5 °C | Hold time within | 30 | Max 30s |
| 5 | C with the actual peak temperature (TP) | | | |
| Cooling speed | | | 6 °C/ | Max 6 °C/ s |
| 25 °C | Needed time from 25 °C to T _p | | 8 | Max 8 minutes |

Notes

(1)Reflow soldering should not be done more than twice. If more than 24 hours between the two solderings, LED will be damaged.

(2)Whensoldering , do not put stress on the LEDs during heating.

3.1.1 Soldering Iron

(1) When do soldering by hand, keep the temperature of iron below less 300°C less than 3 seconds.

(2) Soldering by hand should be done only one time.

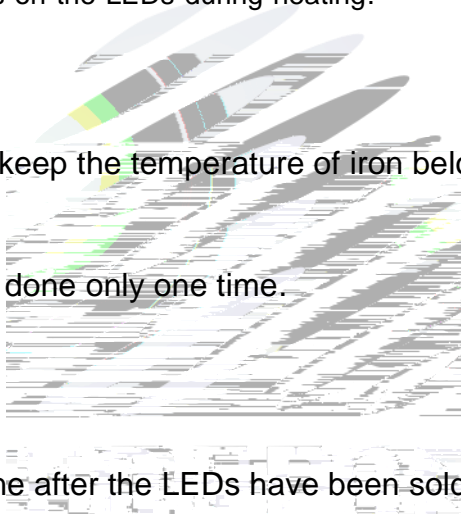

3.1.2 Repairing

Repairing should not be done after the LEDs have been soldered. When repairing is unavoidable,a double-head soldering iron should be used (as below figure). It should be confirmed in advance whether the characteristics of LEDs will or not be damaged by repairing.

LED

3.1.3 Cautions

(1) The encapsulated material of the LEDs is silicone. Therefore the LEDs have a soft surface on the top of package. The pressure to the top surface will be impacted on the reliability of the LEDs. Precautions should be taken to avoid the strong pressure on the encapsulated part. So when use the picking up nozzle, the pressure on the silicone resin should be proper. LED

- (2) Components should not be mounted on warped (non coplanar) portion of PCB. After soldering, do not warp the circuit board.LED
- (3) Do not apply mechanical force or excess vibration during the cooling process to normal temperature after soldering. Do not rapidly cool device after soldering.

4. Handling Precautions

4.1 Handling Precautions

(1) LED operating environment and sulfur element composition cannot be over 100PPM in the LED mating usage material. This is provided for informational purposes only and is not a warranty or endorsement.LED

(2) In order to prevent external material from getting into the inside of LED, which may cause the malfunction of LED, the single content of Bromine element is required to be less than 900PPM, the single content of Chlorine element is required to be less than 900PPM, the total content of Bromine element and Chlorine element in the external materials of the application products is required to be less than 1500PPM. This is provided for informational purposes only and is not a warranty or endorsement.

(3) VOCs (Volatile organic compounds) emitted from materials used in the construction of fixtures can penetrate silicone encapsulants of LEDs and discolor when exposed to heat and photonic energy. The result can be a significant loss of light output from the fixture. Knowledge of the properties of the materials selected to be used in the construction of fixtures can help prevent these issues. Refond advises against the use of any chemicals or materials that have been found or are suspected to have an adverse affect on device performance or reliability. To verify compatibility, Refond recommends that all chemicals and materials be tested in the specific

application and environment for which they are intended to be used. Attaching LEDs, do not use adhesives that outgas organic vapor.

(4) Handle the component along the side surface by using forceps or appropriate tools; Do not directly touch or Handle the silicone lens surface, it may damage the internal circuitry.

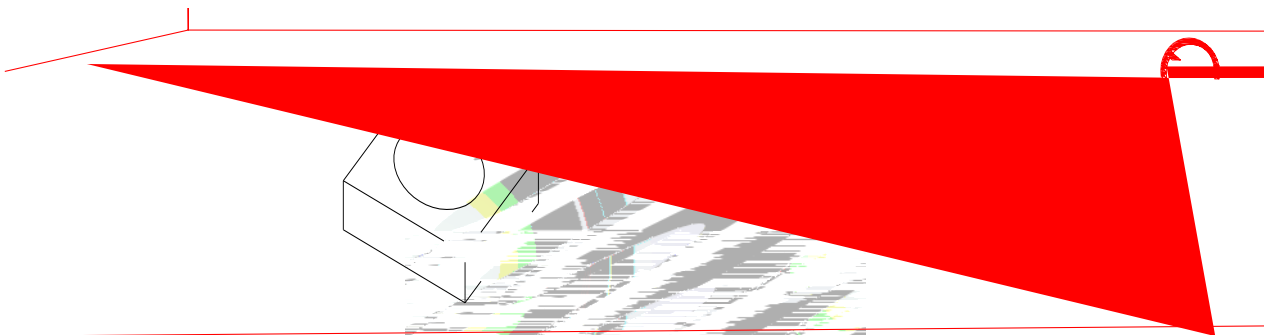
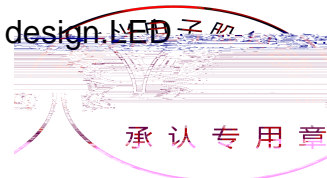

Fig 4-1

产品使用注意事项

(5) In designing a circuit, the current through each LED can not exceed the absolute maximum rating specified for each LED. In the meanwhile, resistors for protection should be applied, otherwise slight voltage shift will cause big current change, burn out may happen. The driving circuit must be designed to allow forward voltage only when it is ON or OFF. If the reverse voltage is applied to LED, migration can be generated resulting in LED damage.

(6) Thermal Design is paramount importance because heat generation may result in the Characteristics decline, such as brightness decreased, Color change and so on. Please consider the heat generation of the LEDs when making the system design.



(7) Compared to standard encapsulants, silicone is generally softer, and the surface is more likely to attract dust, requiring special care during processing. In cases where a minimal level of dirt and

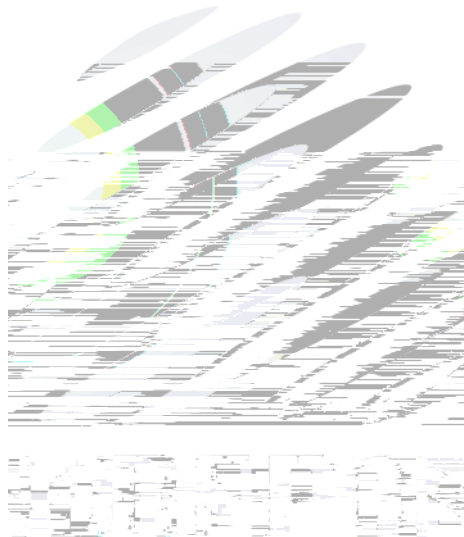

(9) Similar to most Solid state devices; LEDs are sensitive to Electro-Static Discharge (ESD) and Electrical Over Stress (EOS).

(10) Other points for attention, please refer to our relevant information.

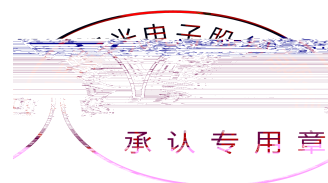
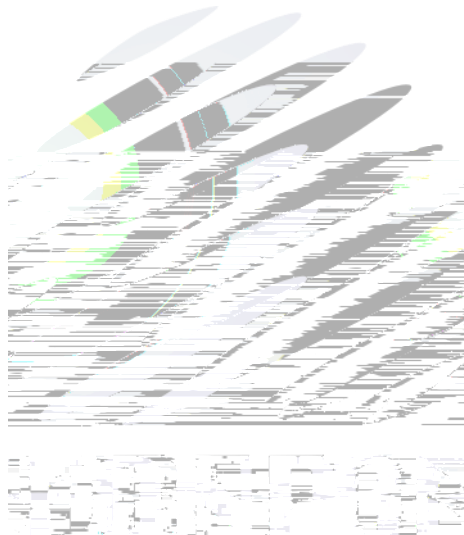



Declare

This specification is written both in English and in Chinese and the latter is formal.

