

瑞光

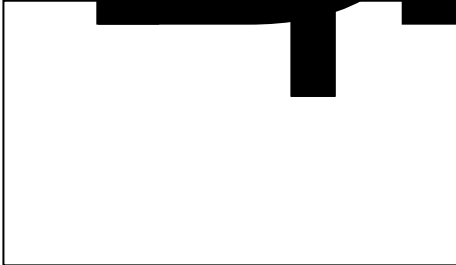

PR;

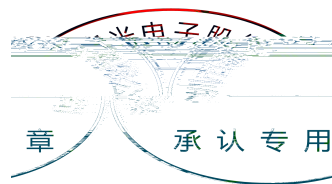

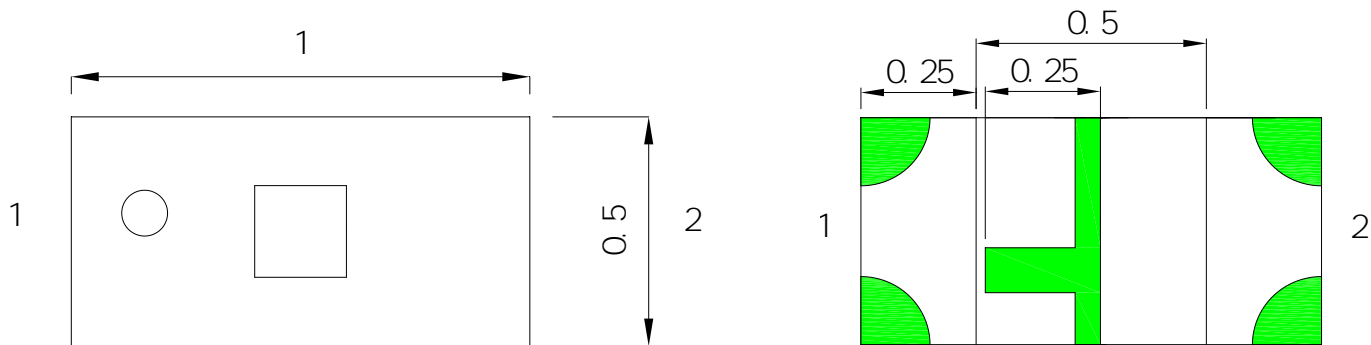

1.

±

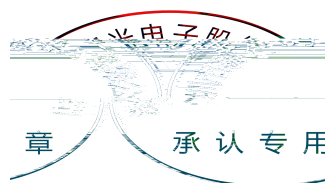

章

承认专用

± 0.2

						μ

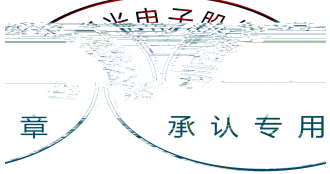

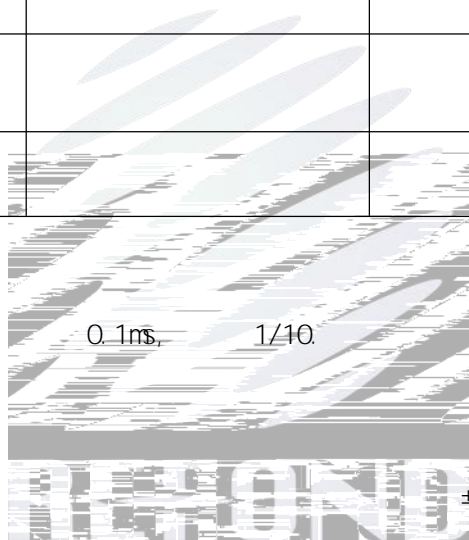

0.1ms, 1/10

± 0.1V.

± 2nm

± 10%

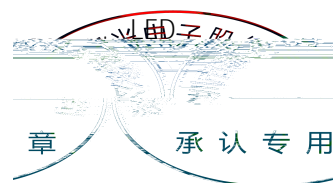

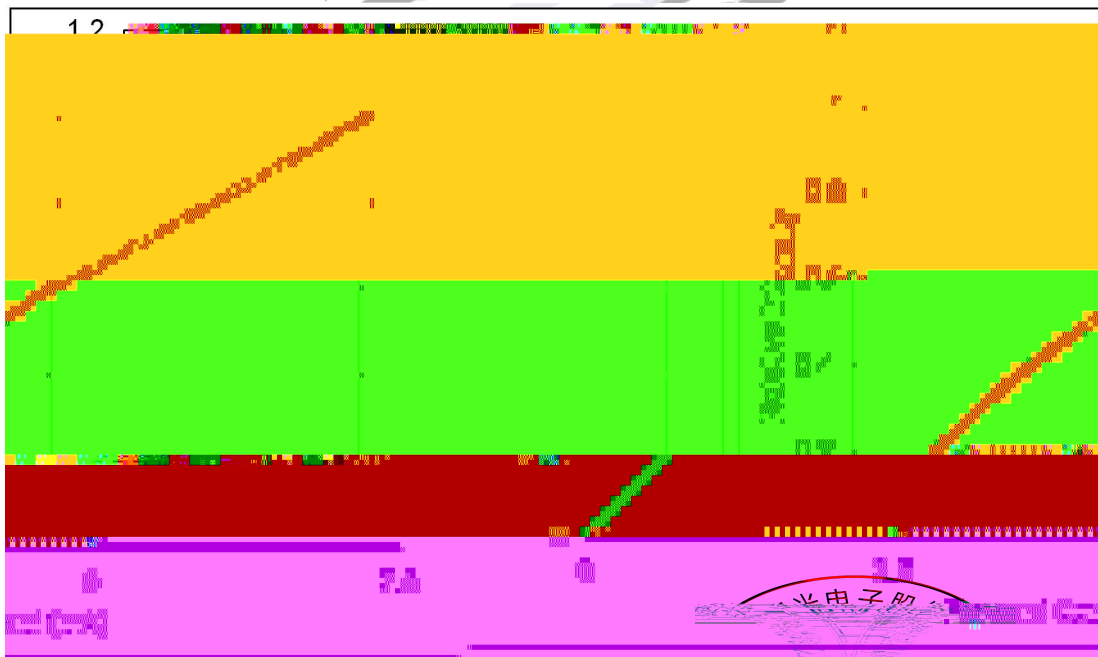
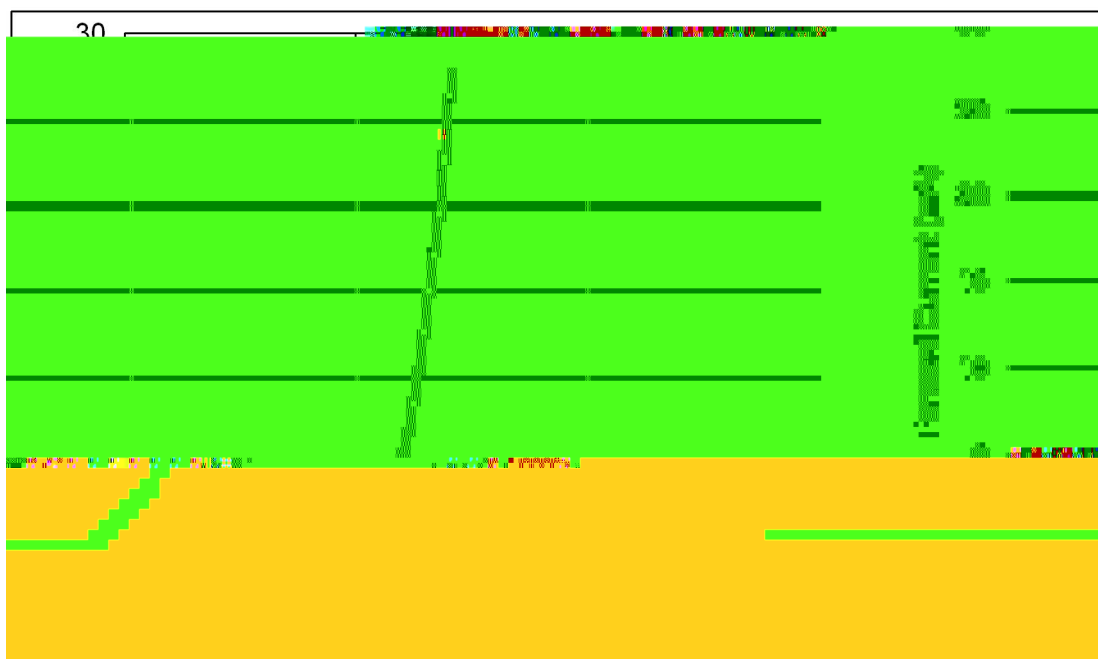

章 承认专用



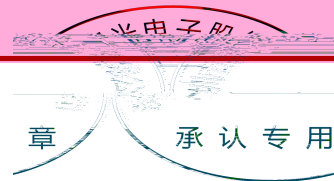
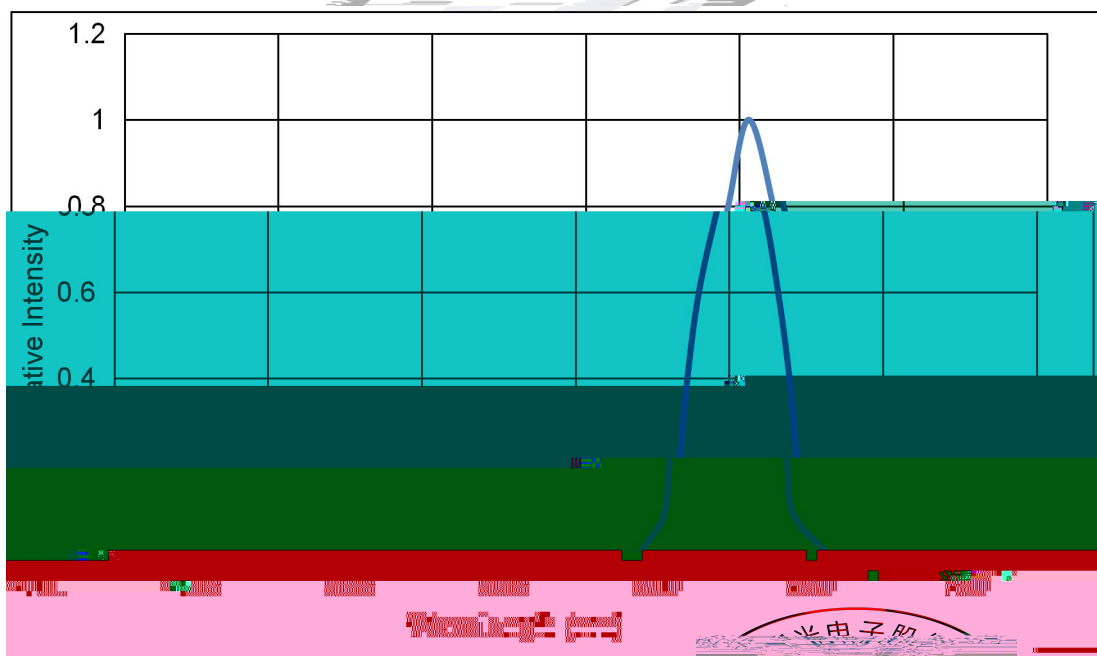
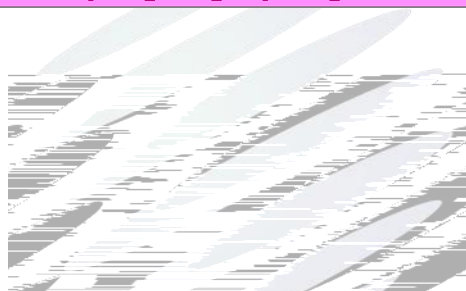
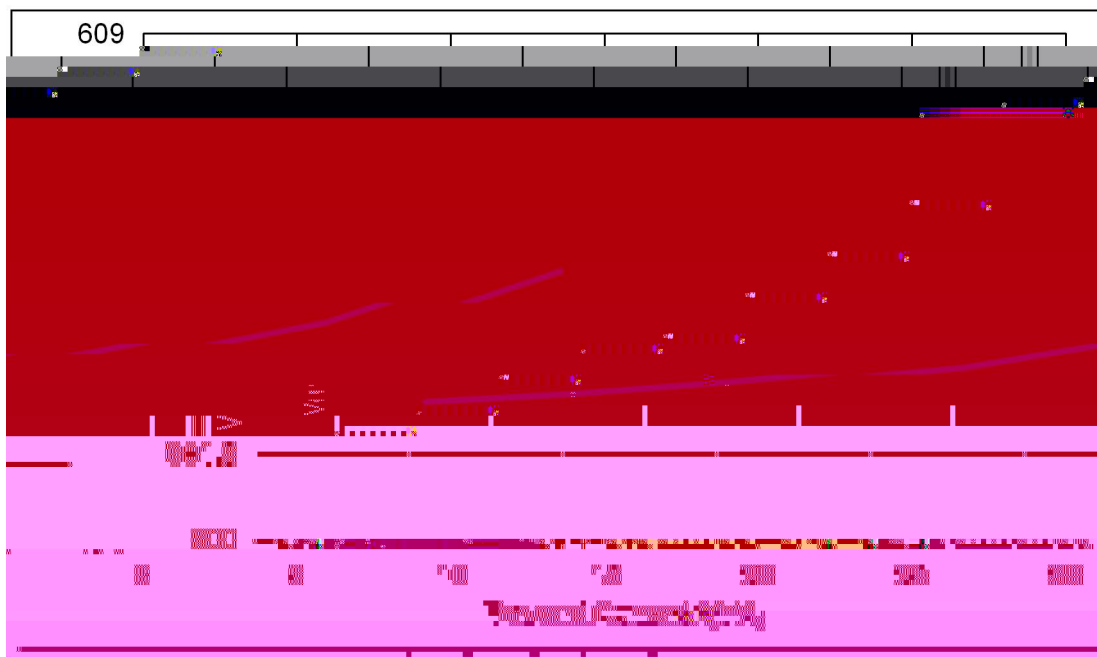

章 承认专用

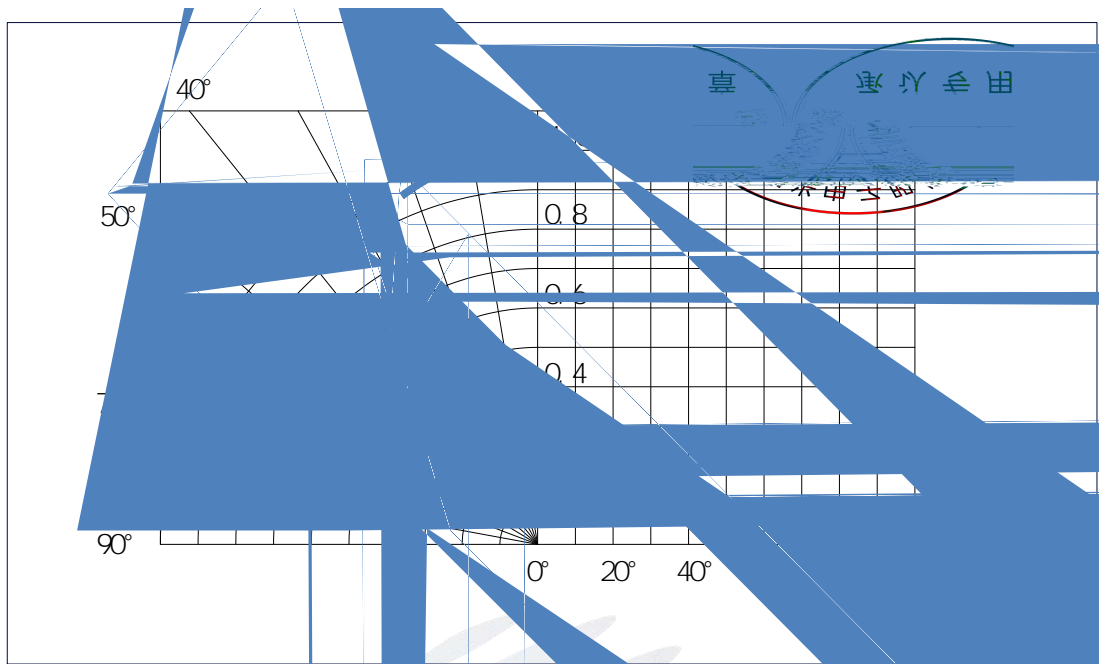

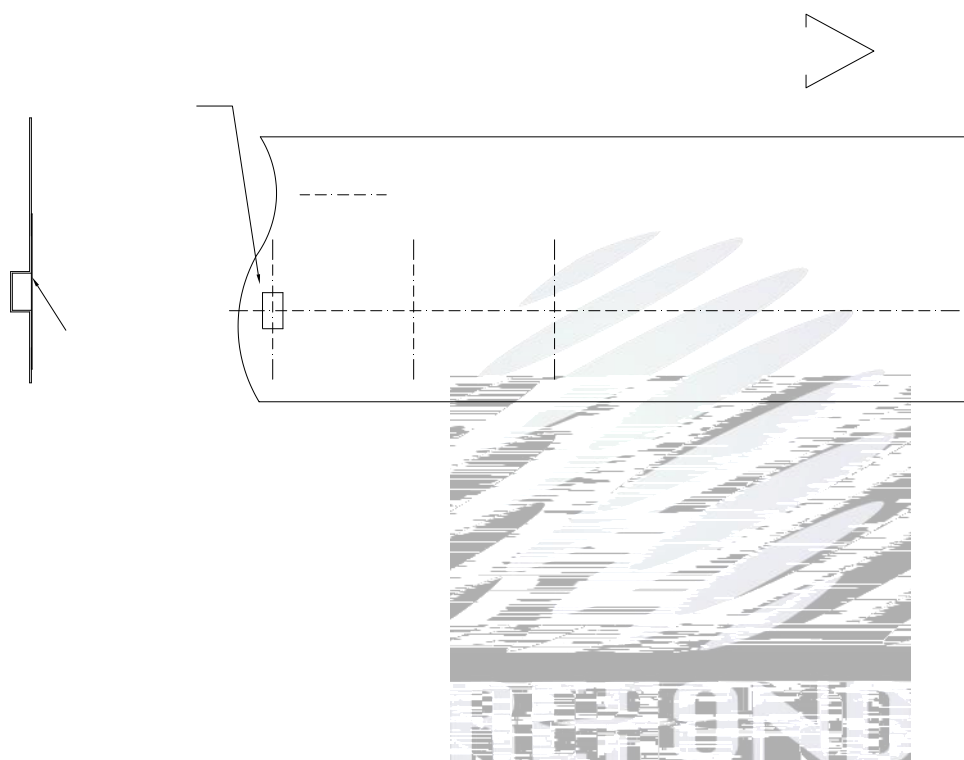



PART NO.:
SPEC NO:
LOT NO

BIN CODE:
Φ: XY:
VF: WLD:

QTY:
DATE:



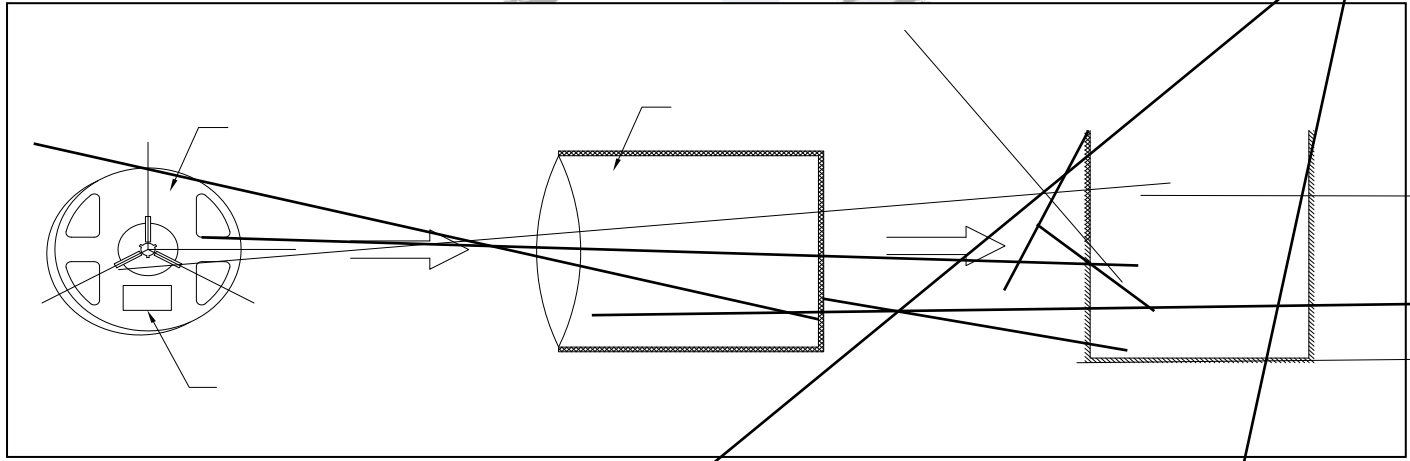

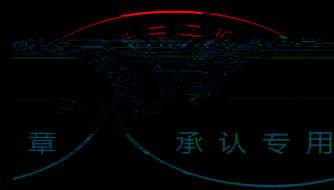
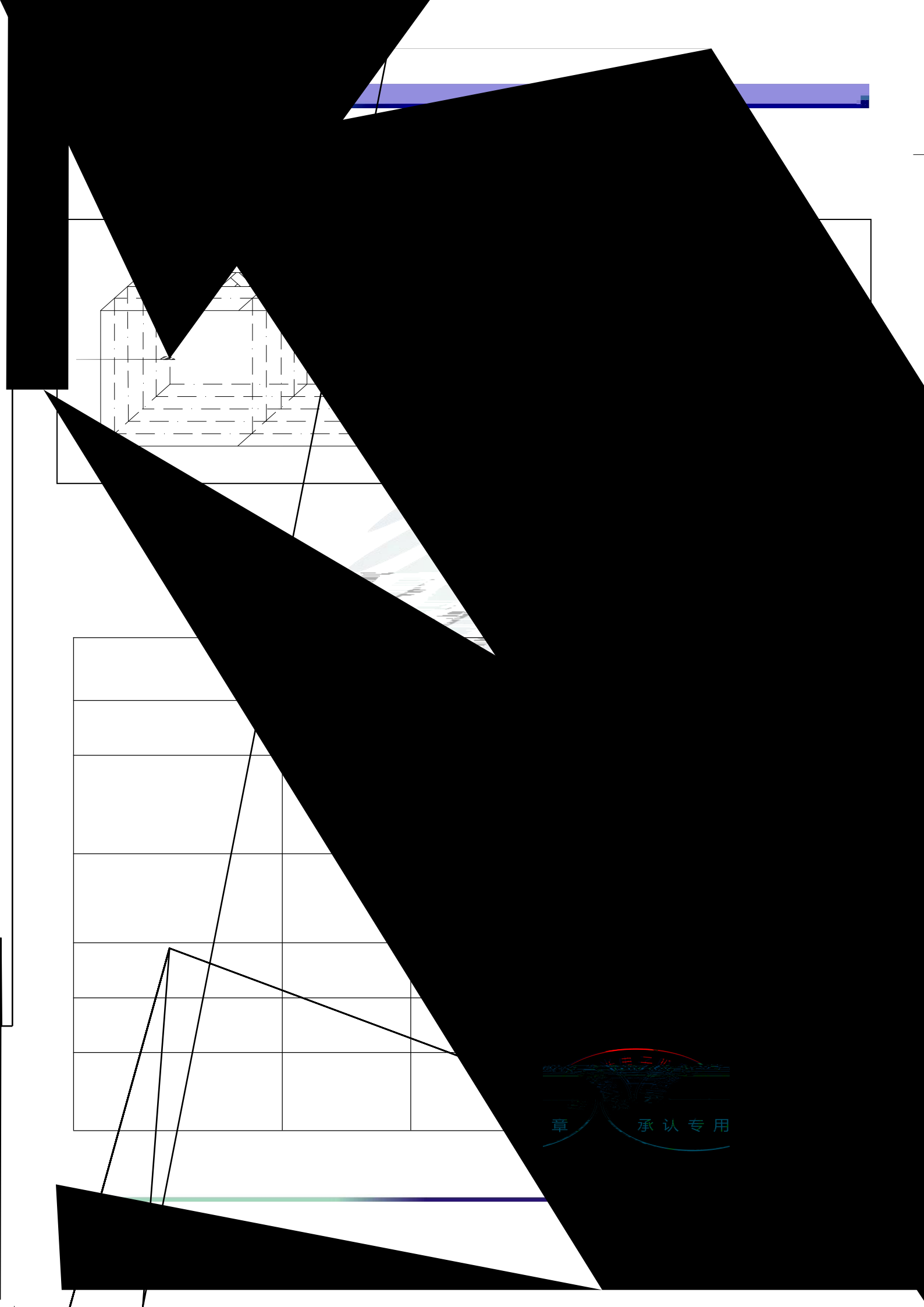



LED

/ LED

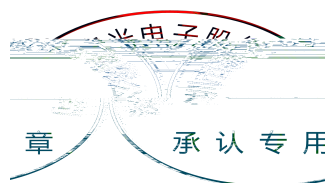



n[.

300

3

LED



PCB

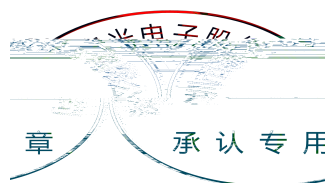

LED

100PPM

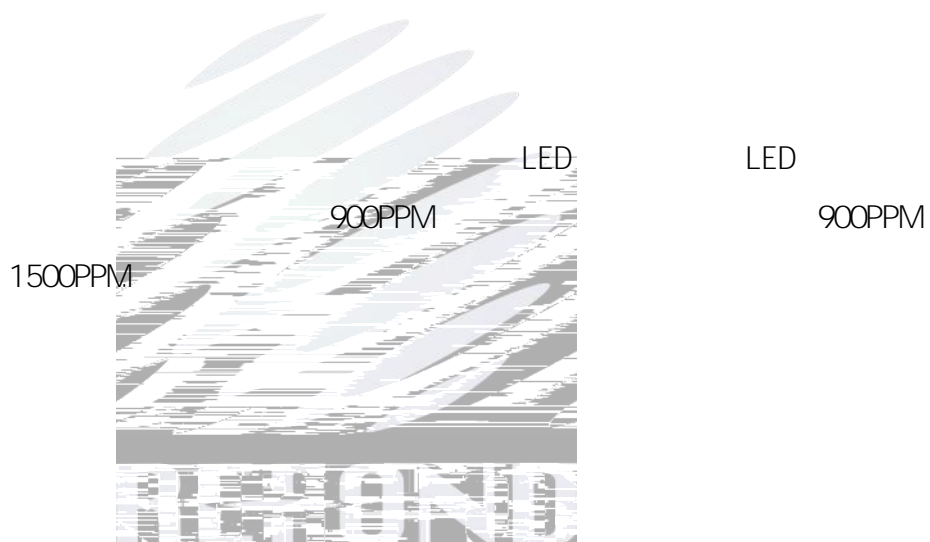

LED
LED

LED

LED

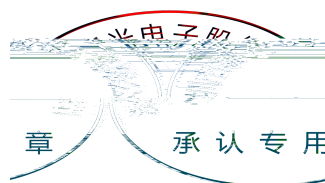

LED

LED

LED

		±		

±

60± 5

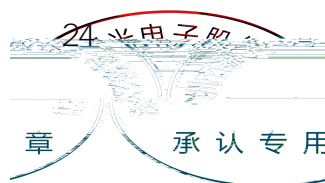

LED

