

±

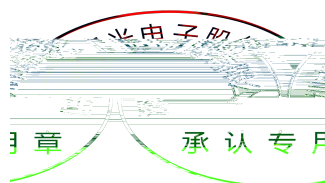

						μ

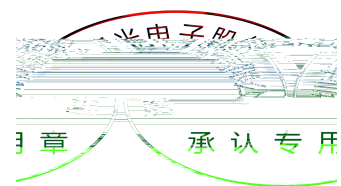

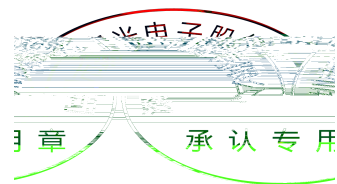
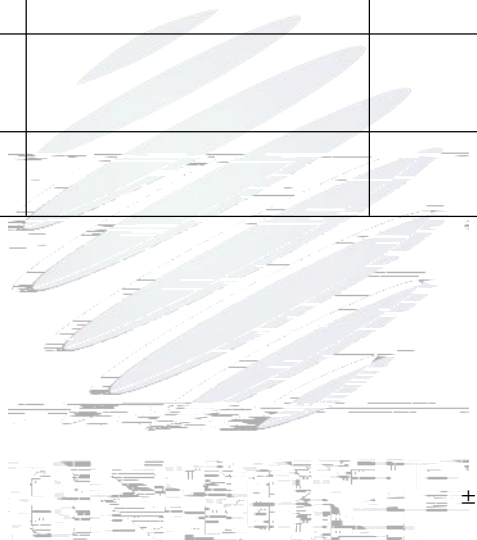

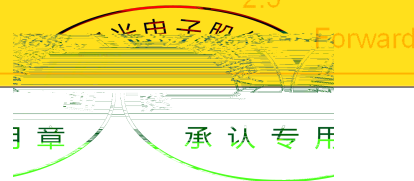
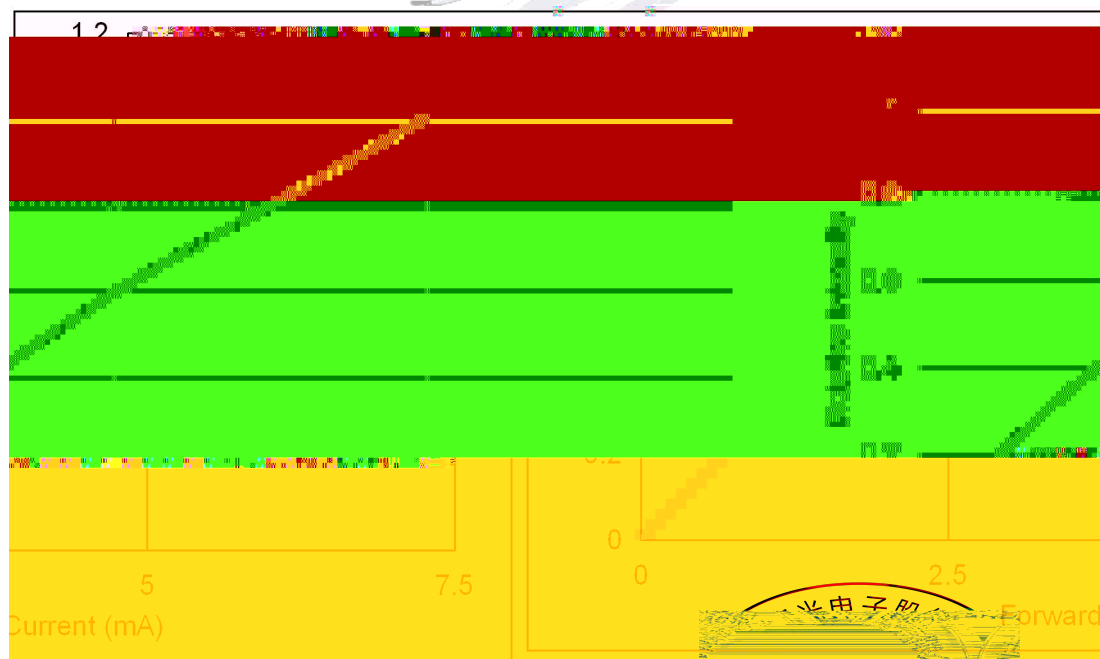
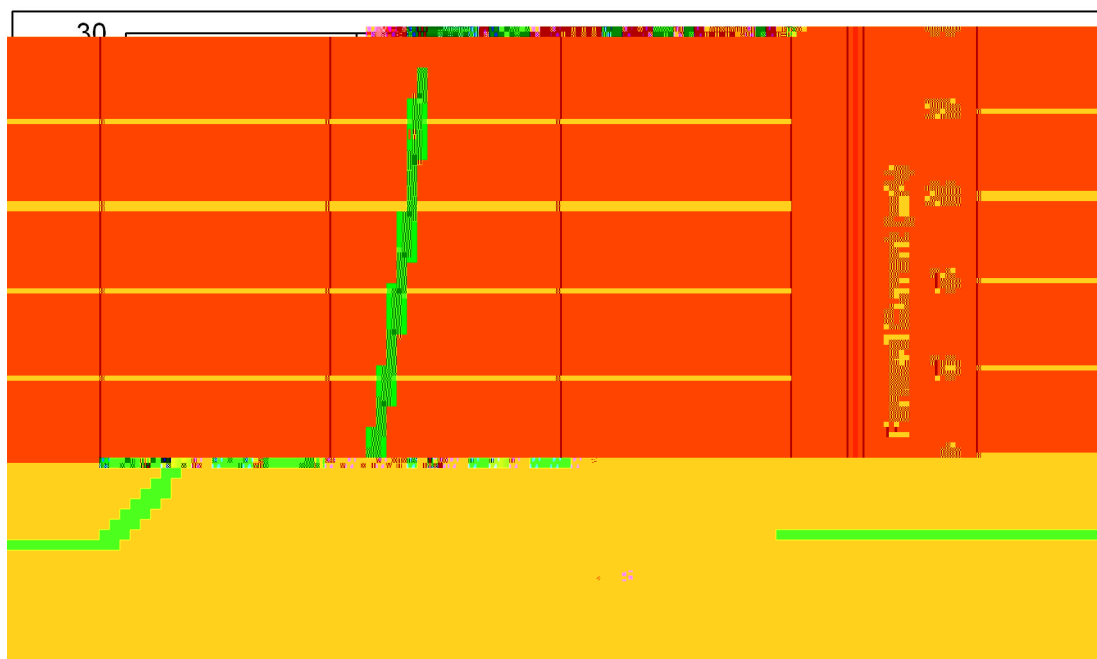

印章 承认专用

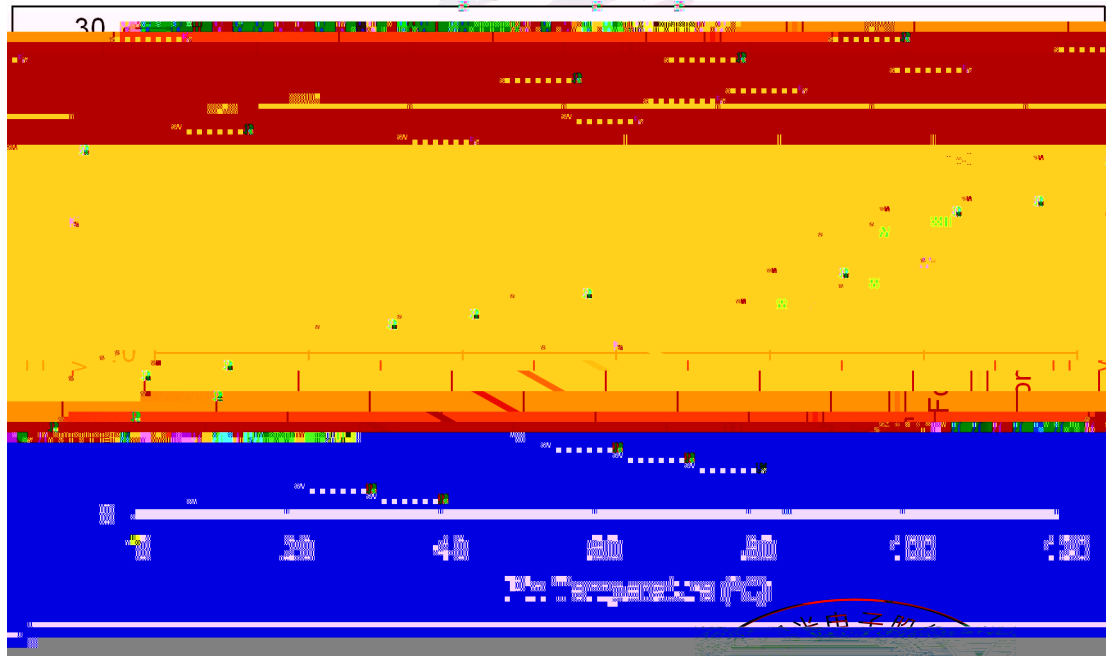
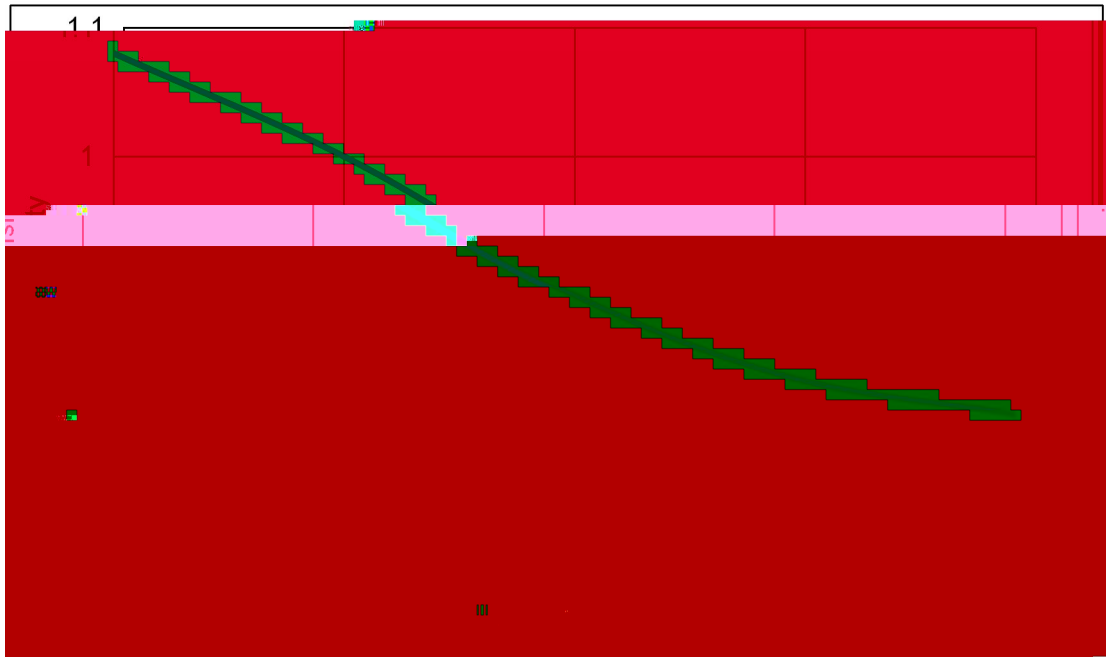

專章 承認專用

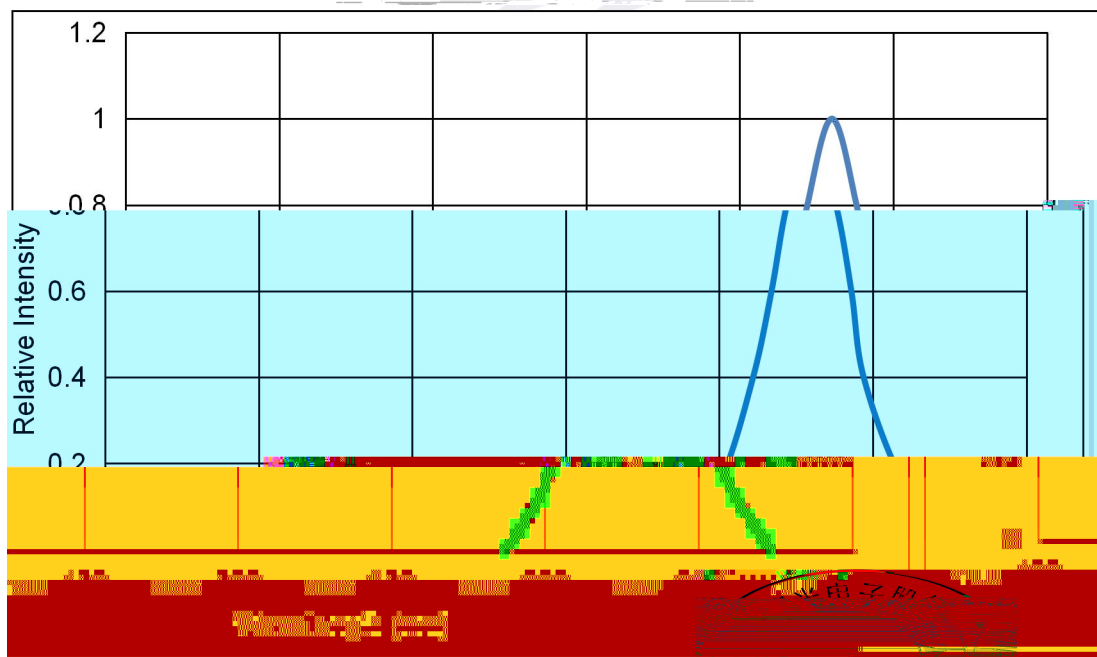
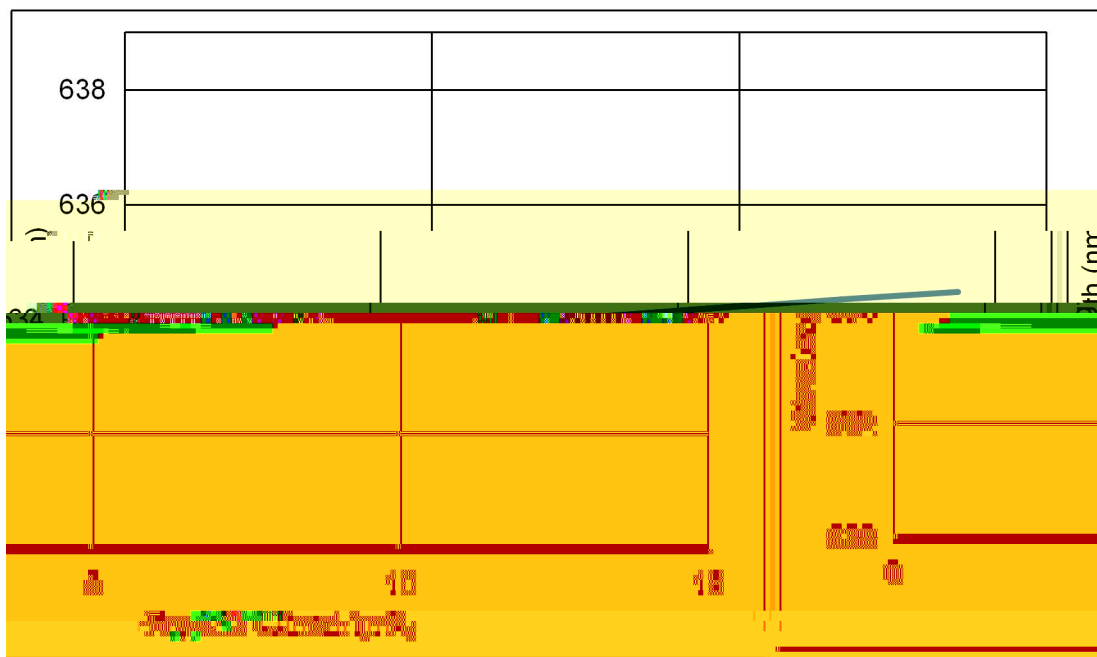

印章 承认专用

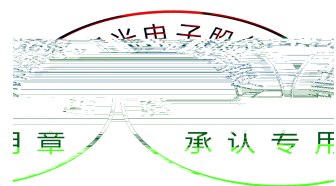
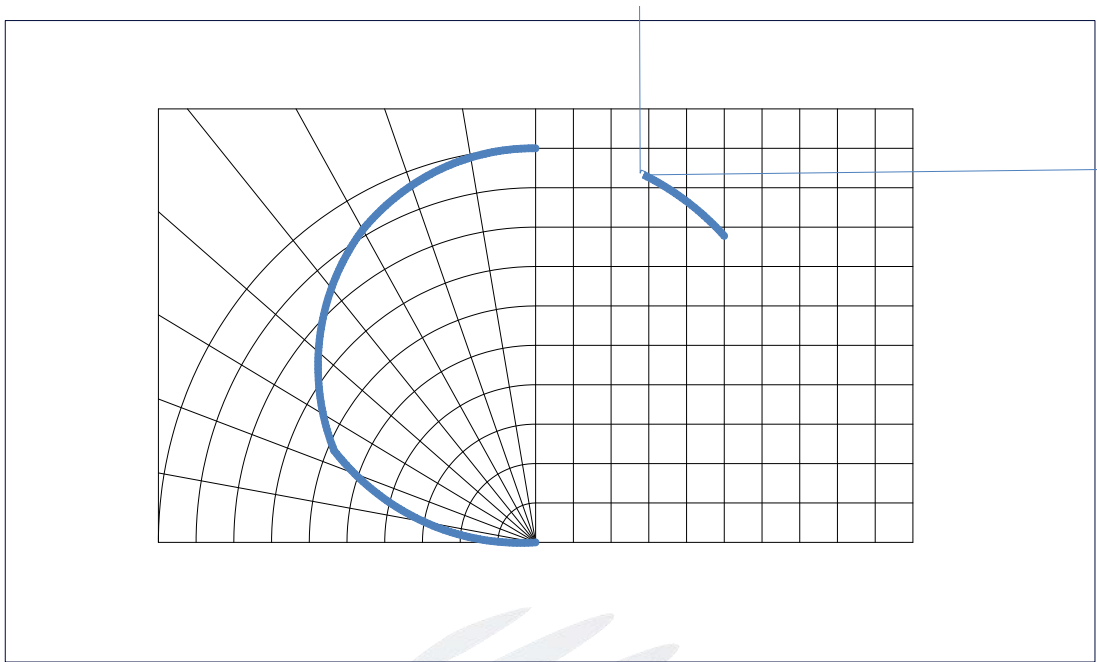

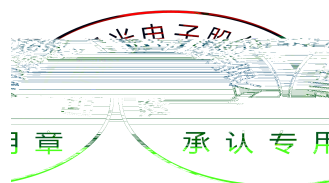
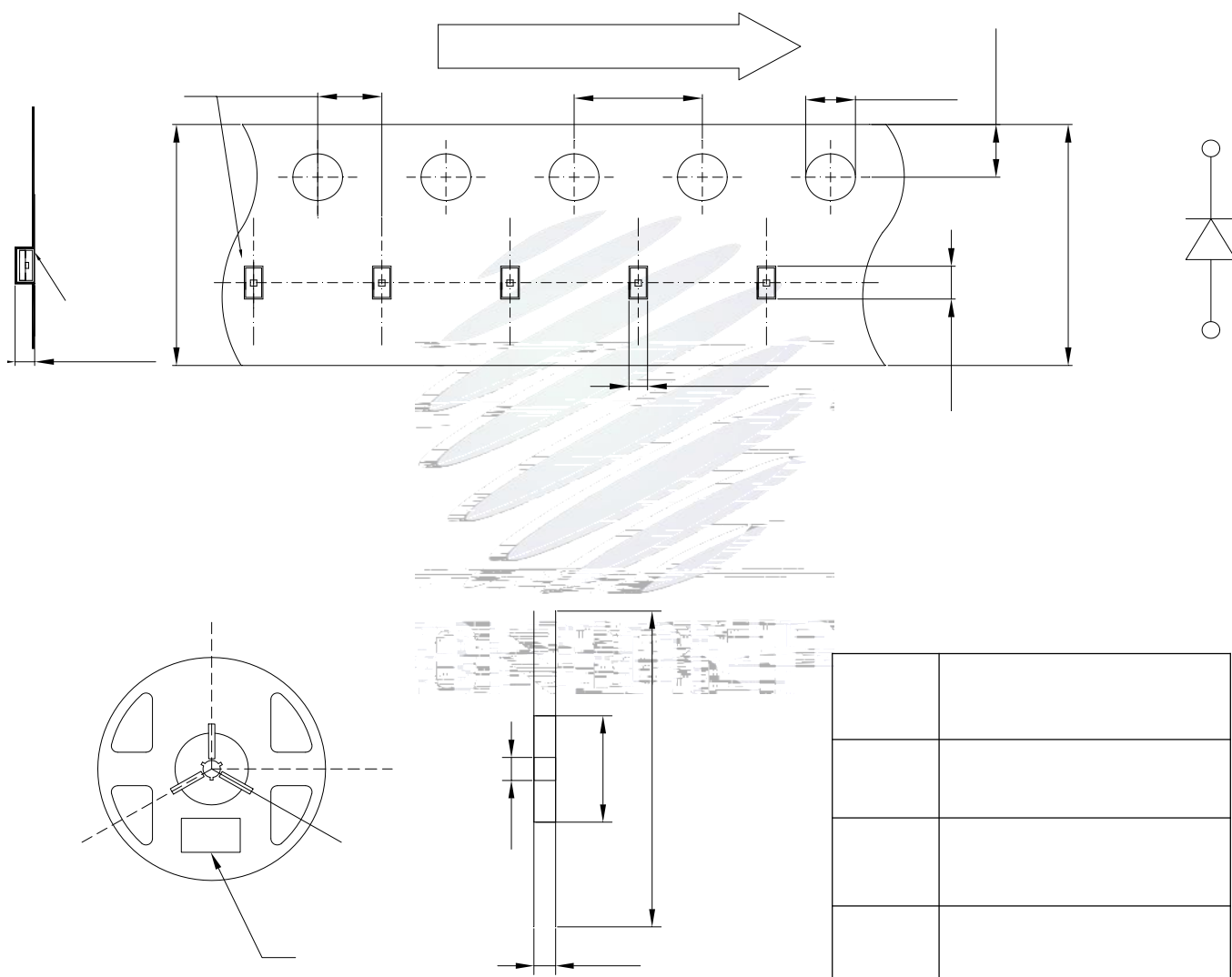

PART NO: .
 SPEC NO:
 LOT NO

BIN CODE:
 Φ: XY:
 VF: WLD:

QTY:
 DATE:



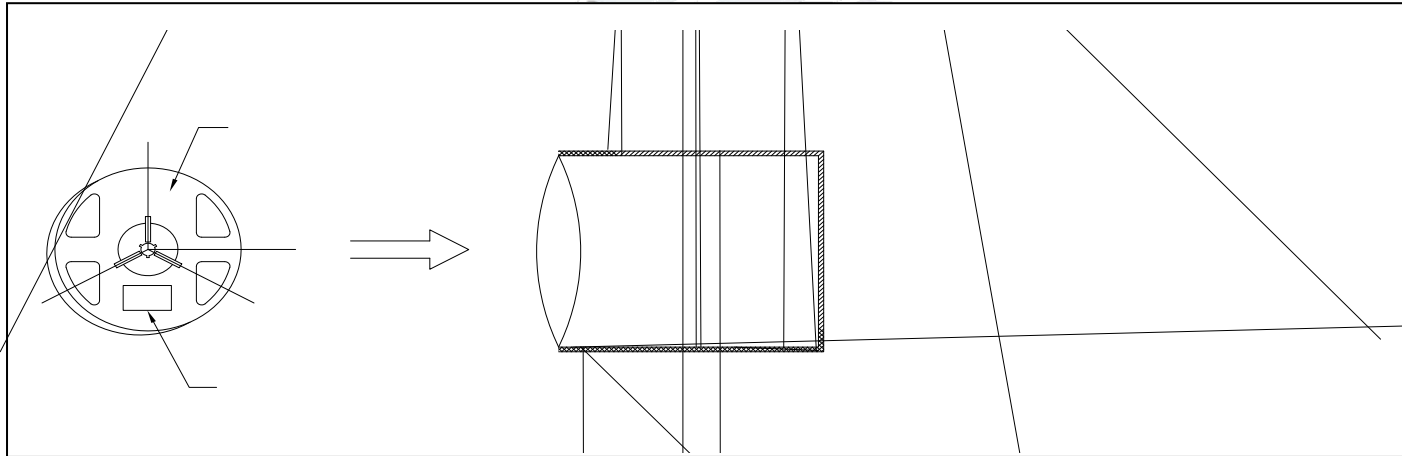

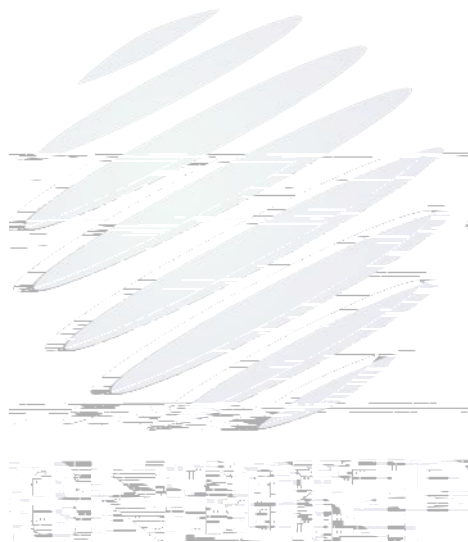

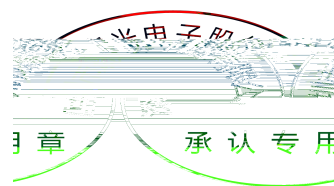
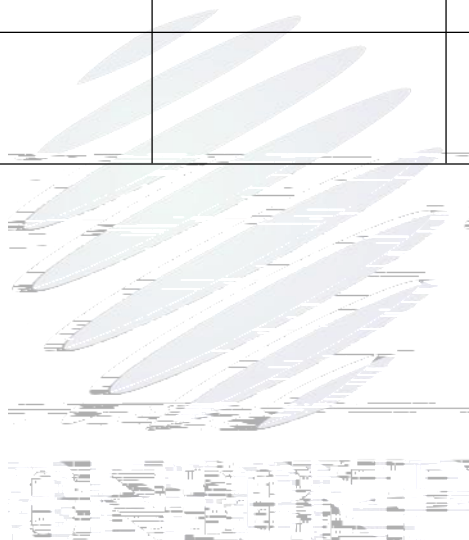

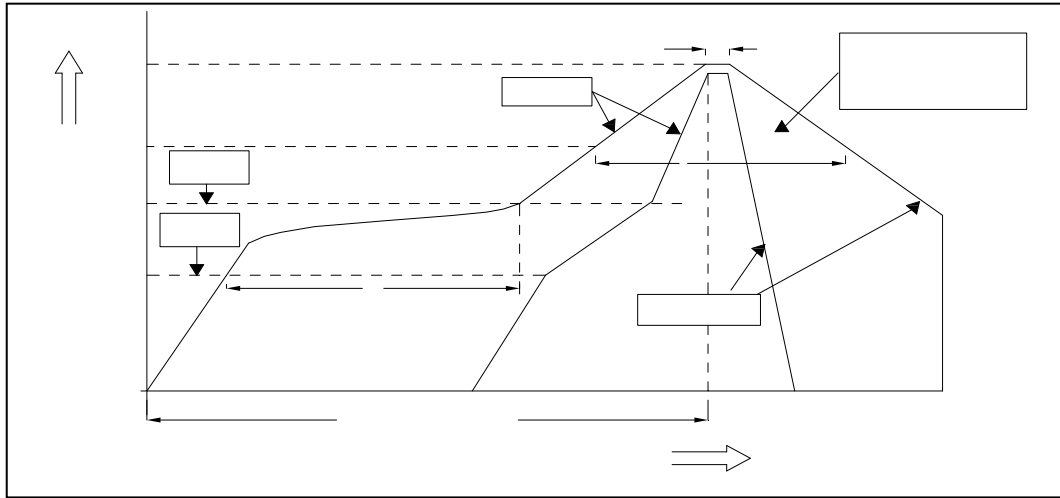

<p>行业中助 专注 承认</p>	

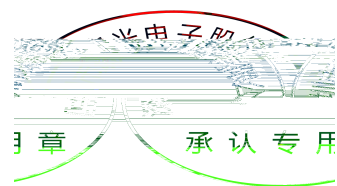
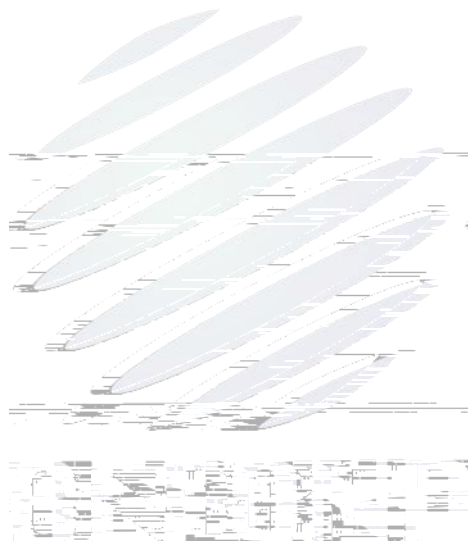

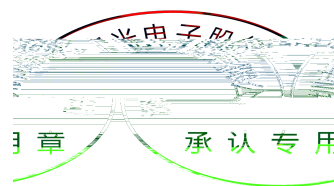
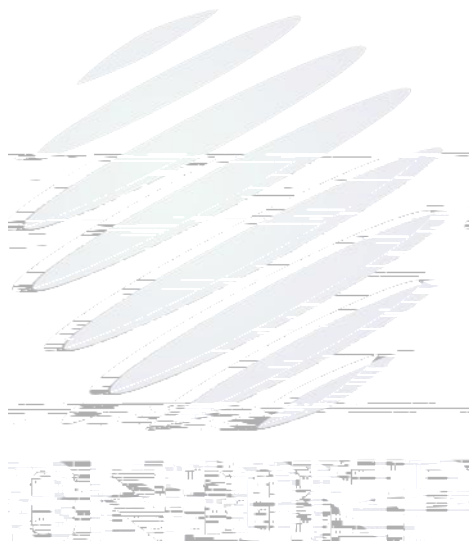

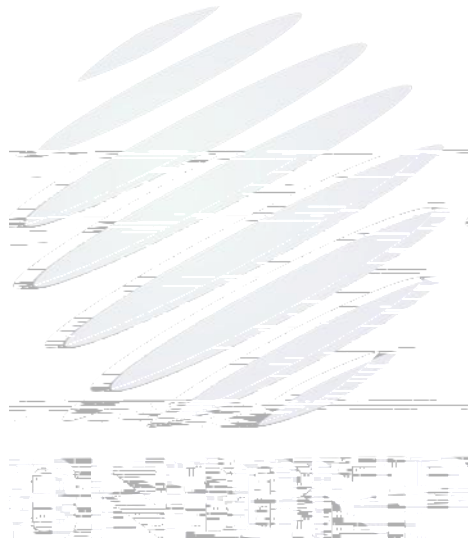
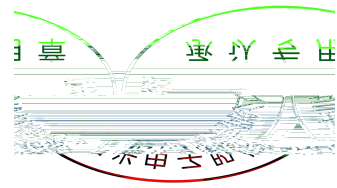

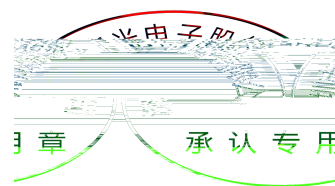
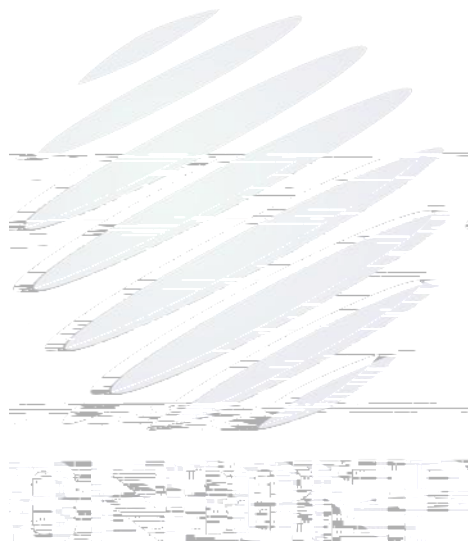
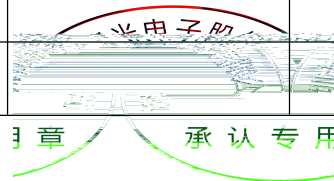

Table with 5 columns and 20 rows. The top row has a light blue header. The table contains a large watermark in the center with the text '光電子' and '光電子' and '光電子'.



印章 承认专用

