

SPECIFICATION

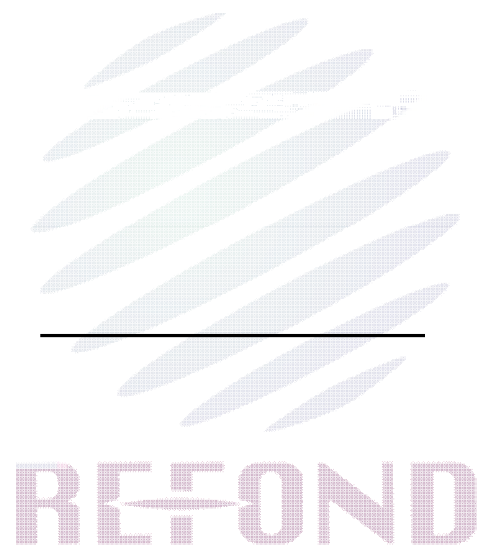



.....

.....

.....

.....

.....

..... ? ? ? ?



1. Description

1.1

1.2Features

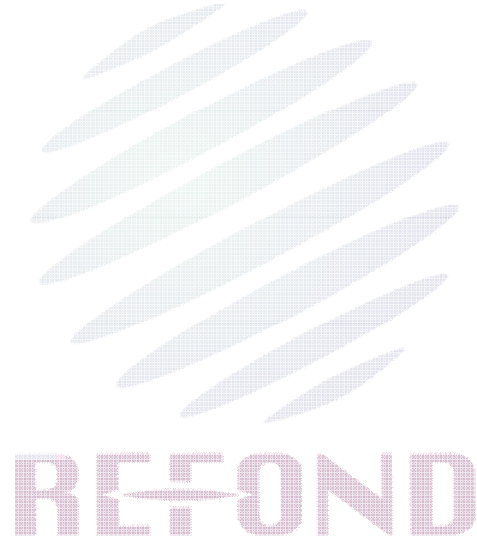



光雨

1.4P e Dimension

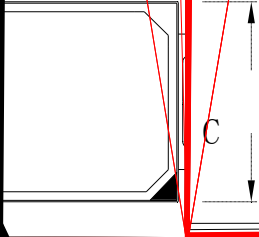

BEFOND

1.5 Product Parameters



瑞豐光電



1.6 Bin Range Of Forward Voltage and Luminous Flux

BIN

0.3 —▲

0.37 —

0.35 —

0.33 —

0.31 —

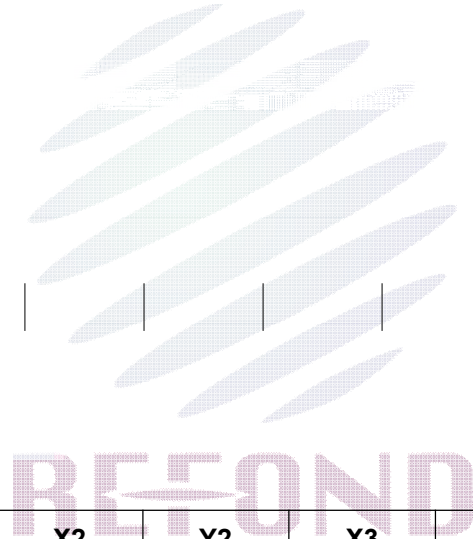

	X1		Y1		X2		Y2		X3		Y3		X4		Y4	
	X1	Y1	X2	Y2	X3	Y3	X4	Y4	X5	Y5	X6	Y6				

1.7 Typical optical characteristics curves

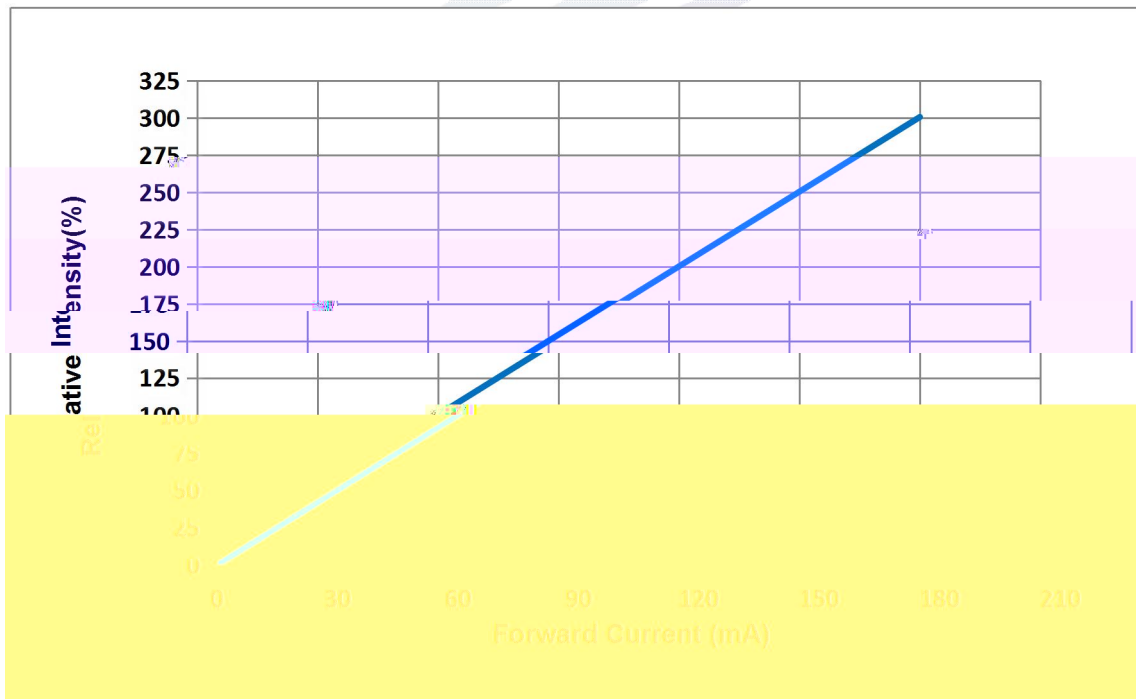
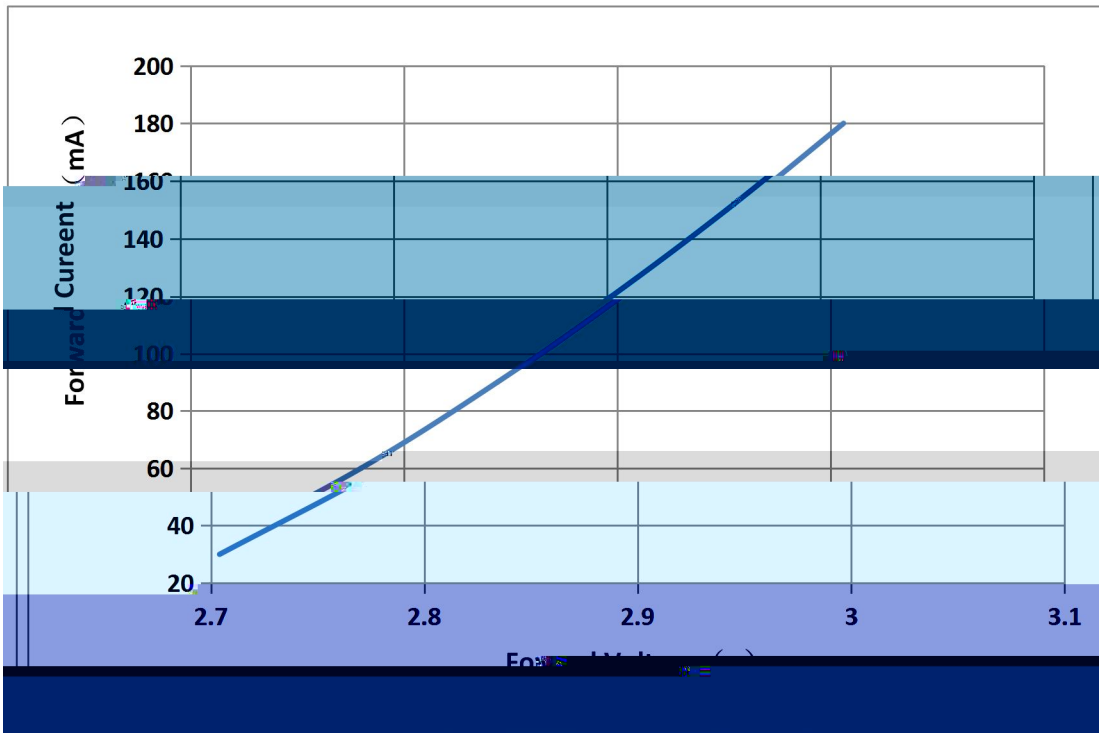

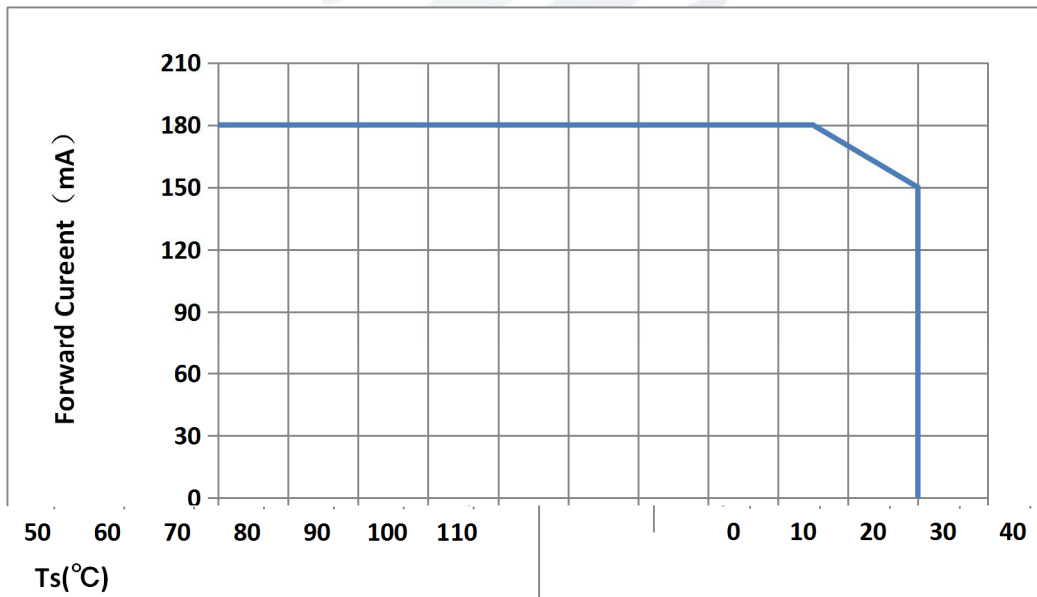
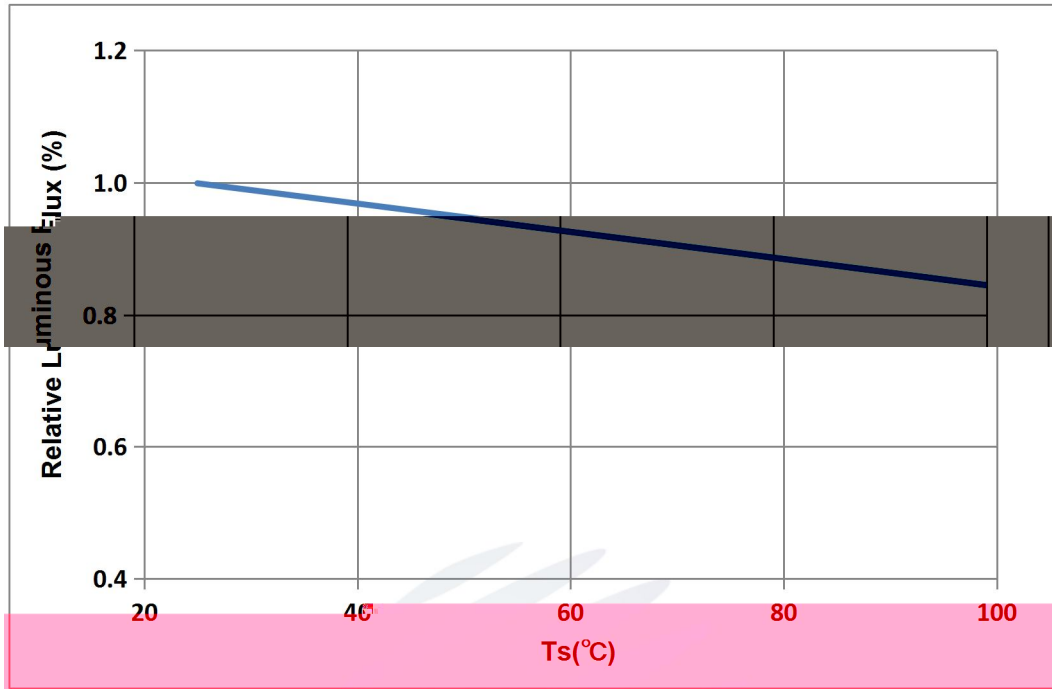

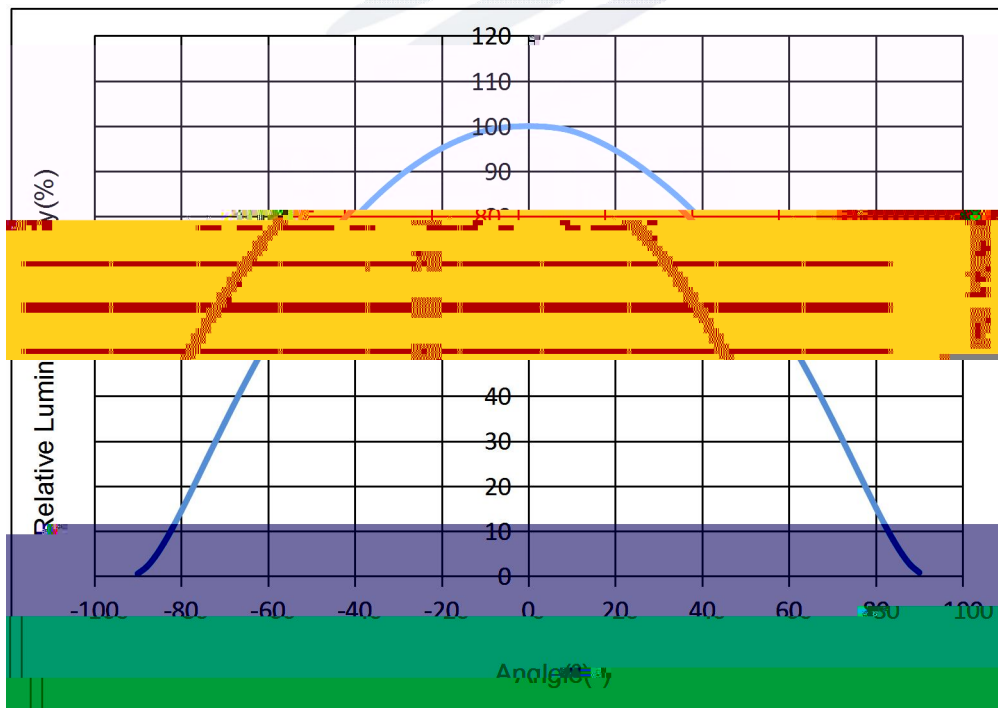
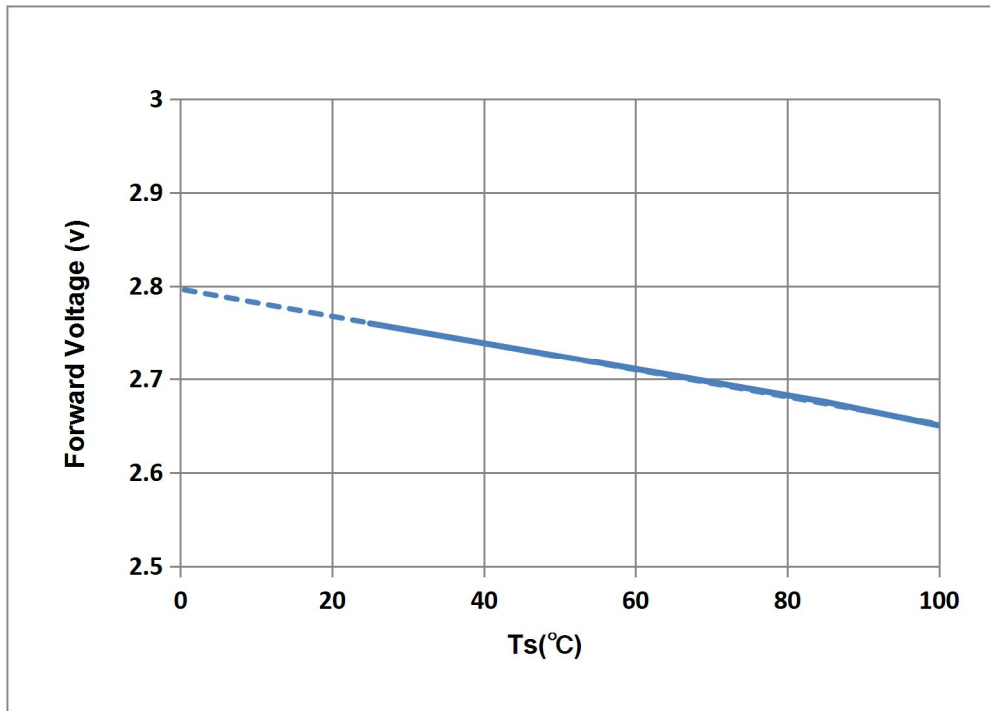

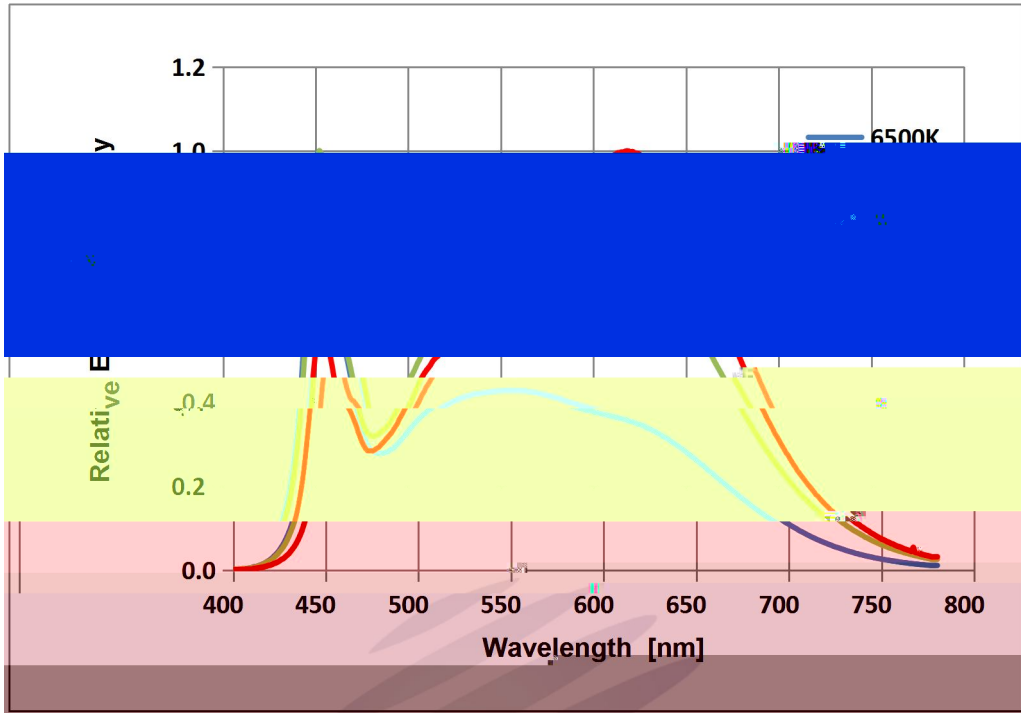

REFOND

2 . Packaging

2.1 Packaging Specification

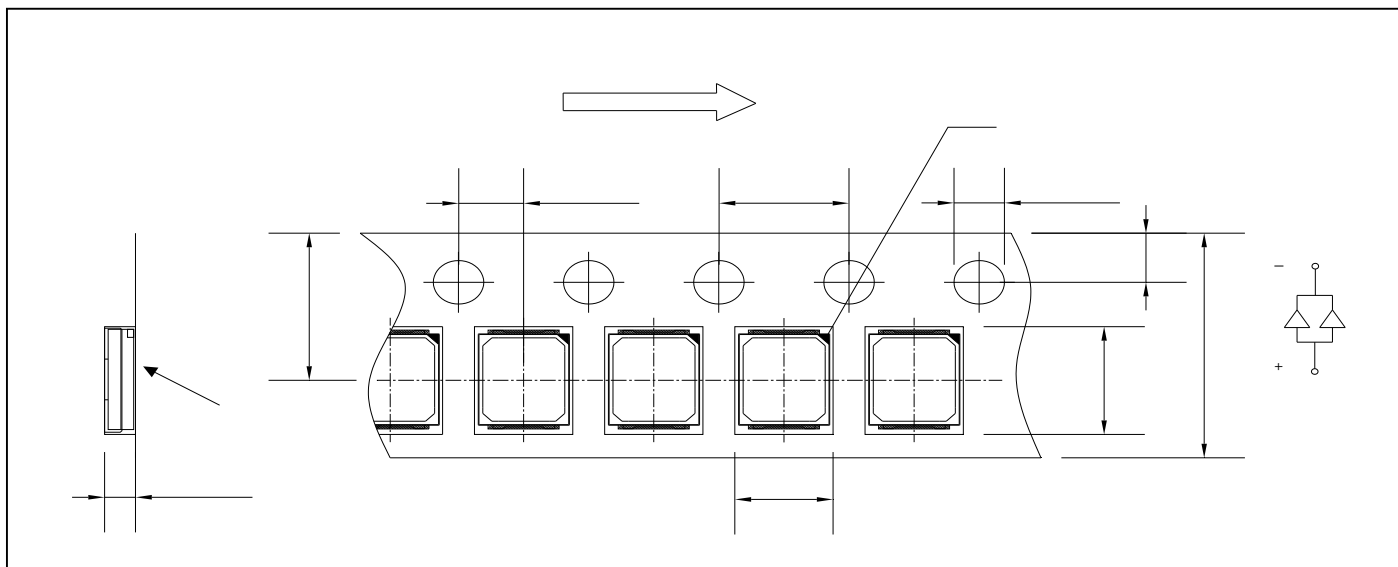

REFOND

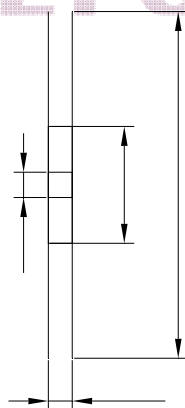
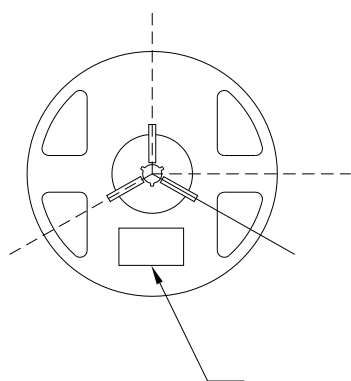

PART NO:		
SPEC NO:		
LOT NO		
BIN CODE:		
Φ:	XY:	
VF:	WLD:	
	QTY:	
	DATE:	

2.2 Moisture Resistant Packing

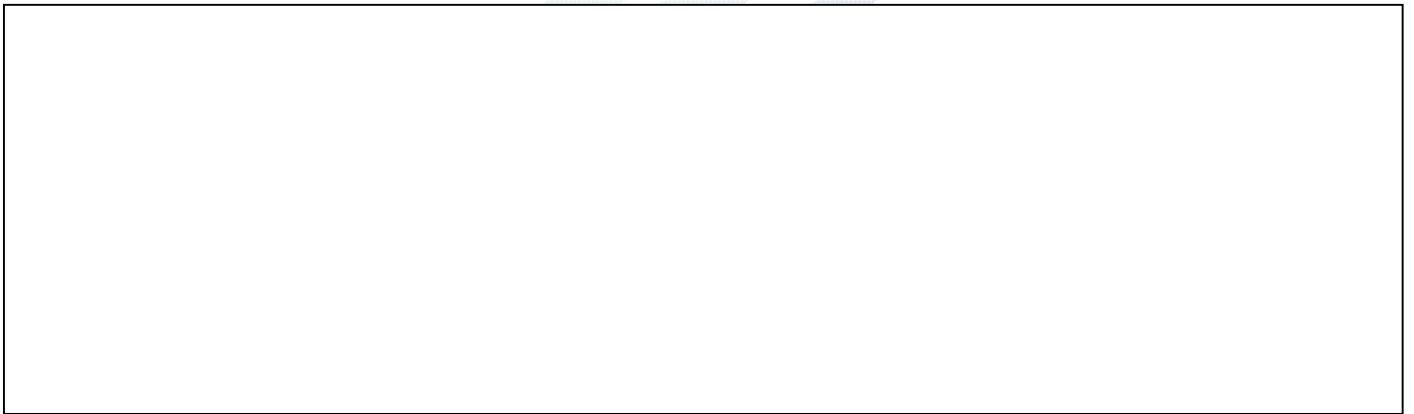

2.3 Cardboard Box

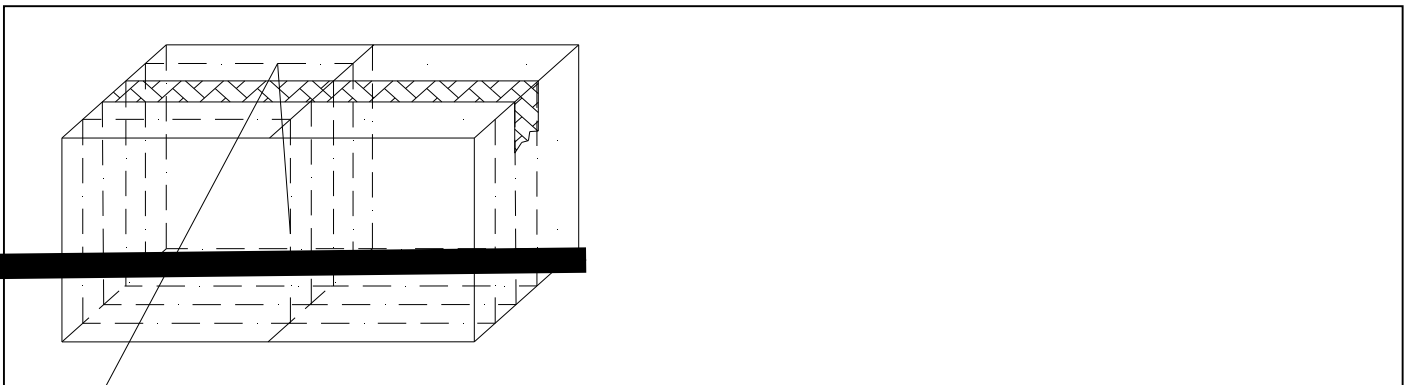



瑞豐光電



2.5 Criteria For Judging Damage

REFOND

3 SMT Reflow Soldering Instructions SMT

3.1 SMT Reflow Soldering Instructions SMT

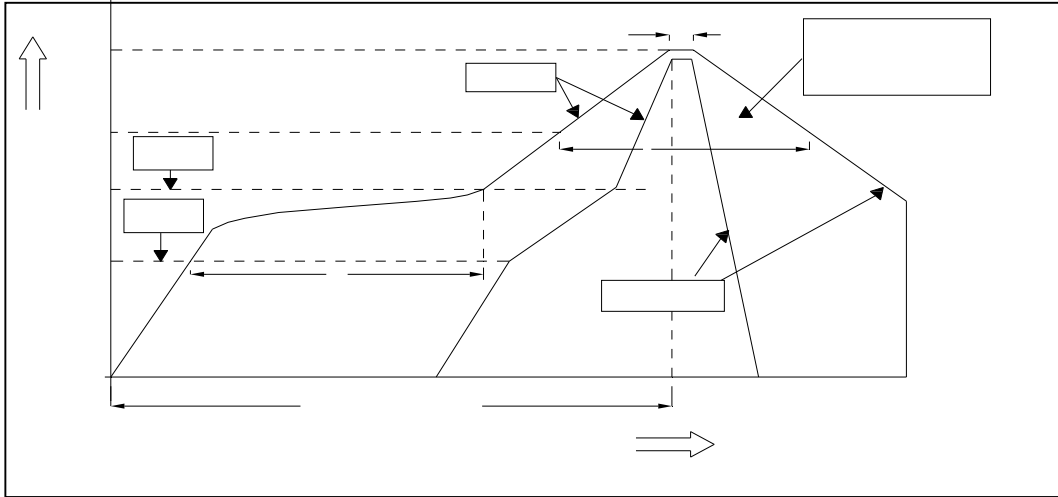



瑞豐光電



4. Handling Precautions

4.1 Handling Precautions

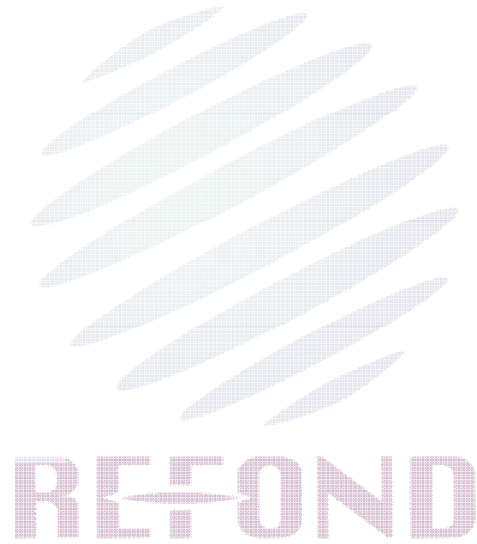

BRAND



REFOND



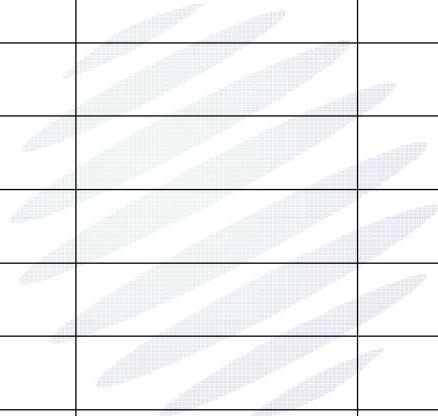

REFOND

