

SPECIFICATION

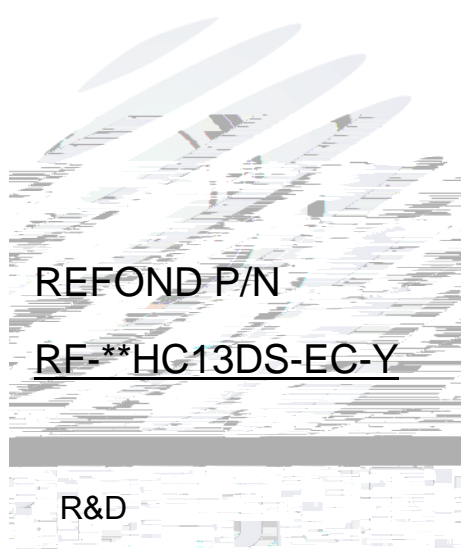

REFOND P/N

RF-**HC13DS-EG-Y

R&D

Mass Product

Contents

| | | |
|--|-----|----|
| 1. Description | | 3 |
| 1.1 General Description | | 3 |
| 1.2 Features | | 3 |
| 1.3 Application | | 3 |
| 1.4 Package Dimension | | 4 |
| 1.5 Product Parameters | | 5 |
| 1.6 Bin Range Of Forward Voltage and Luminous Flux (IF=20mA) | BIN | |
| (IF=20mA) | | 7 |
| 1.7 The Chromaticity Diagram | | 8 |
| 1.8 Typical optical characteristics curves | | 10 |
| 2. Packaging | | 14 |
| 2.1 Packaging Specification | | 14 |
| 2.2 Moisture Resistant Packing | | 15 |
| 2.3 Cardboard Box | | 15 |
| 2.4 Reliability Test Items And Conditions | | 16 |
| 2.5 Criteria For Judging Damage | | 17 |
| 3. SMT Reflow Soldering Instructions SMT | | 18 |
| 3.1 SMT Reflow Soldering Instructions SMT | | 18 |
| 4. Handling Precautions | | 20 |
| 4.1 Handling Precautions | | 20 |

1. Description

1.1



The White LED which was fabricated using a blue chip and the phosphor.

Dimension :3.0mmX1.5mmX1.38mm.

LED

3.0mmX1.5mmX1.38mm

1.2 Features

PLCC Package. PLCC

Extremely wide viewing angle.

Suitable for all SMT assembly and solder process.

Available on tape and reel.

Moisture sensitivity level: Level 3.

Level 3

RoHS compliant.

RoHS

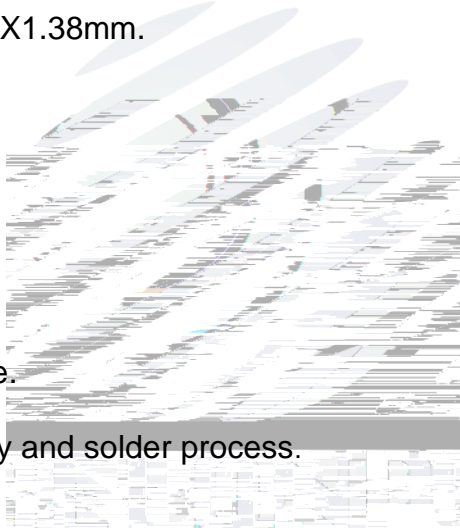

SMT

1.3 Application

Hotels,markets,offices,household and other indoor uses.

Optical indicator.

Indoor display.

Decorative lighting.

General use.

1.4 Package Dimension

Fig.1-1 Top view

Fig.1-2 Side view

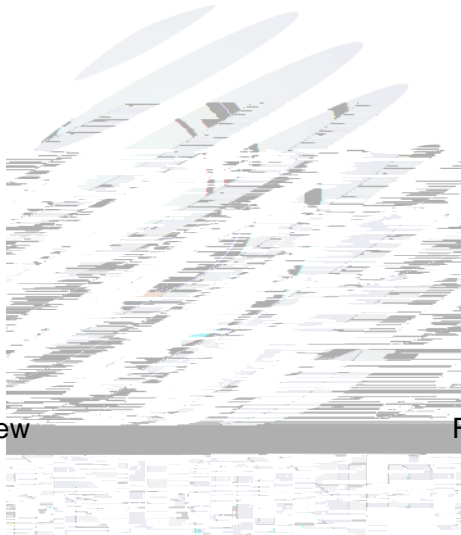

Fig.1-3 Bottom view

Fig.1-4 Side view

Fig.1-5 Soldering patterns

1.5 Product Parameters

Table 1-1 Electrical / Optical Characteristics at Ts=25°C

| Item | Symbol | Test Condition | Value | | | Unit |
|------------------------------|-------------|----------------|-------|-----|------|-------------|
| | | | Min. | Typ | Max. | |
| Forward Voltage | V_F | $I_F=20mA$ | 2.6 | --- | 3.4 | V |
| Reverse Current | I_R | $V_R=5V$ | --- | --- | 10 | μA |
| Luminous Flux | | $I_F=20mA$ | 6 | --- | 12 | lm |
| Viewing Angle | 2 1/2 | $I_F=20mA$ | --- | 120 | --- | deg |
| Color Rendering Index () | R_a | $I_F=20mA$ | 80 | --- | --- | --- |
| Thermal Resistance. | R_{THJ-S} | $I_F=20mA$ | --- | 65 | --- | $\text{}/W$ |

Table 1-2 Absolute Maximum Ratings at Ts=25°C

| Parameter | Symbol | Rating | Units |
|----------------------|----------|--------|-------|
| Power Dissipation | P_D | 132 | mW |
| Forward Current | I_F | 40 | mA |
| Peak Forward Current | I_{FP} | 100 | mA |
| Reverse Voltage | V_R | 5 | V |

EI864

Notes

1. 1/10 Duty cycle, 0.1ms pulse width. 0.1ms, 1/10.
2. The above forward voltage measurement allowance tolerance is $\pm 0.1V$.
3. The above color coordinates measurement allowance tolerance is 0.005. 0.005.
4. The above luminous intensity measurement allowance tolerance $\pm 10\%$.
5. The above Color Rendering Index measurement allowance tolerance is ± 1 . Ra ± 1 .
6. Care is to be taken that power dissipation does not exceed the absolute maximum rating of the product. 使用
7. All measurements were made under the standardized environment of Refond.
8. When the LEDs are in operation the maximum current should be decided after measuring the package temperature, junction temperature should not exceed the maximum rate. LED

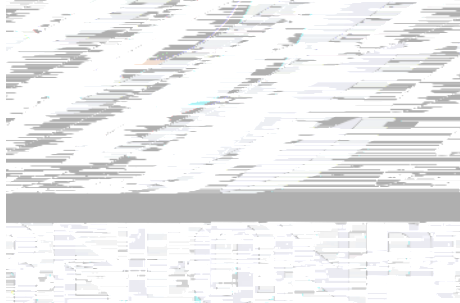

1.6 Bin Range Of Forward Voltage and Luminous Flux (IF=20mA)

BIN (IF=20mA)

Table 1-3

| V _F (V) | F2 | G1 | G2 | H1 | H2 | I1 | I2 |
|--------------------|----|---------|---------|---------|---------|---------|---------|
| | | 2.7-2.8 | 2.8-2.9 | 2.9-3.0 | 3.0-3.1 | 3.1-3.2 | 3.2-3.3 |

RF-27HC

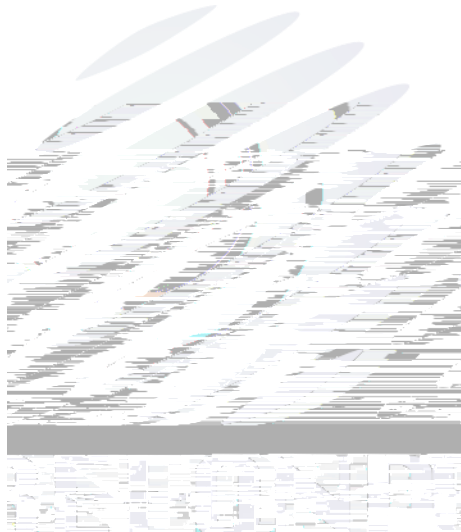



1.8 Typical optical characteristics curves

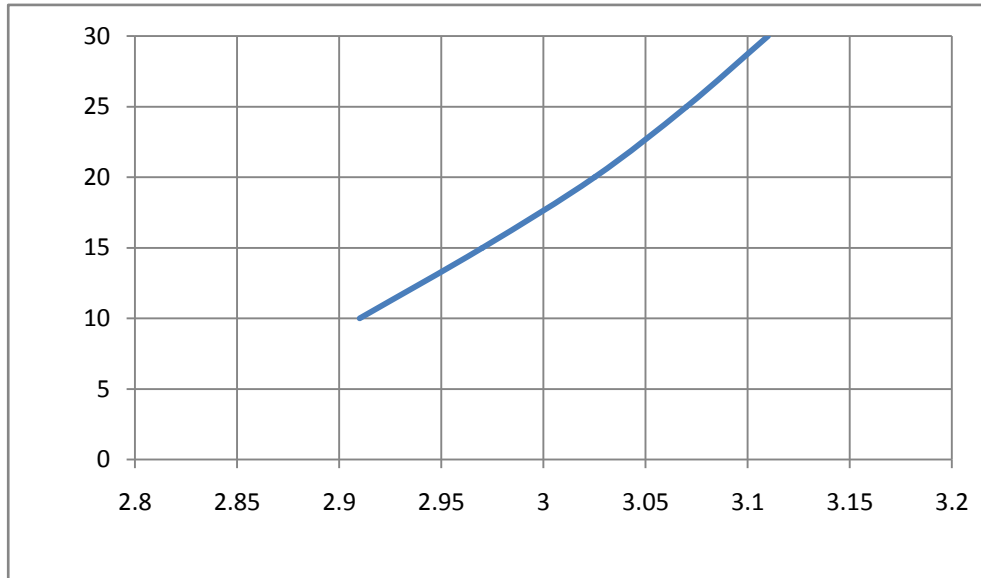

Fig 1-8 Forward Voltage Vs. Forward Current

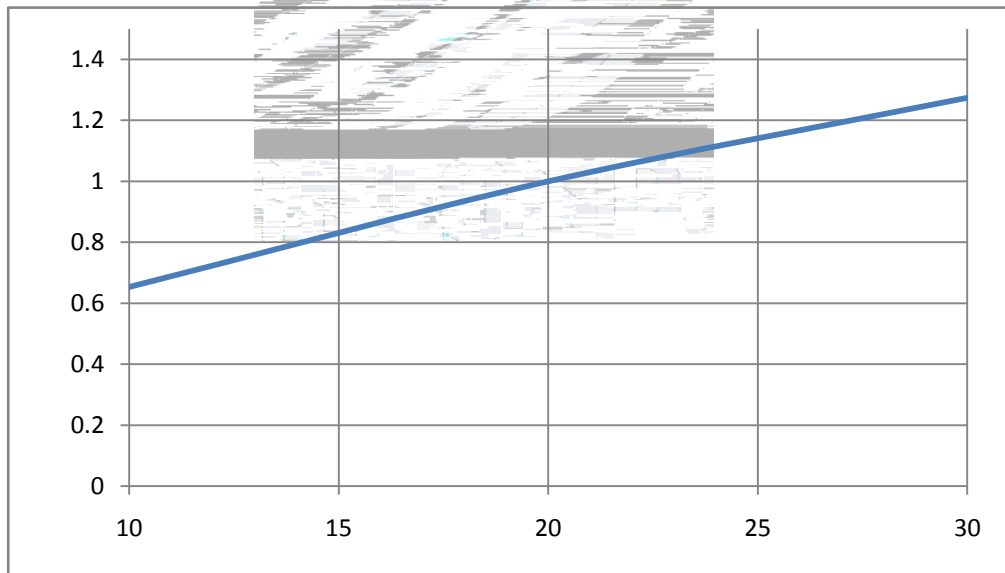

Fig 1-9 Forward Current Vs. Relative Intensity

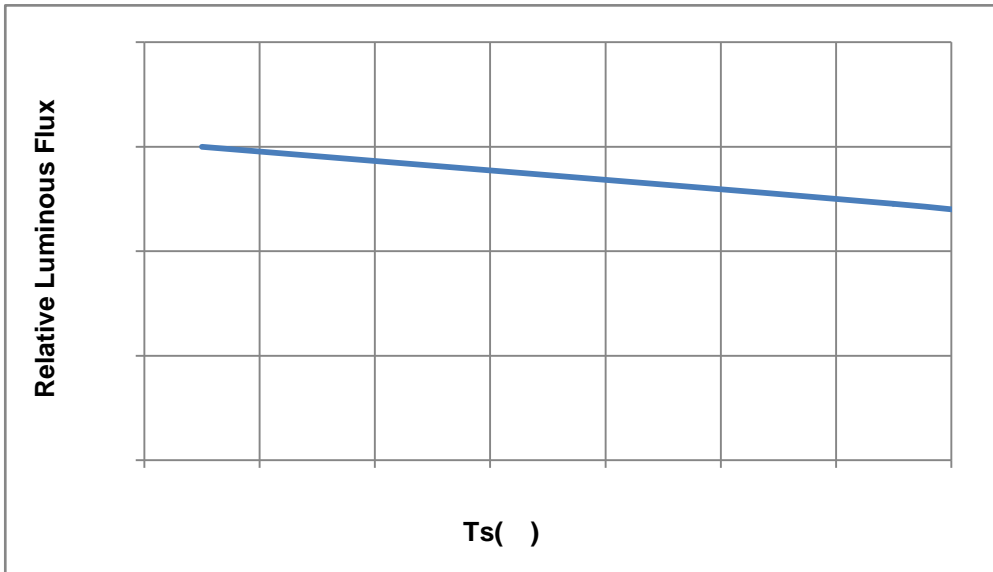

Fig 1-10 Solder Temperature Vs Relative Intensity



Fig 1-11 Solder Temperature Vs Forward Current

Tj 92

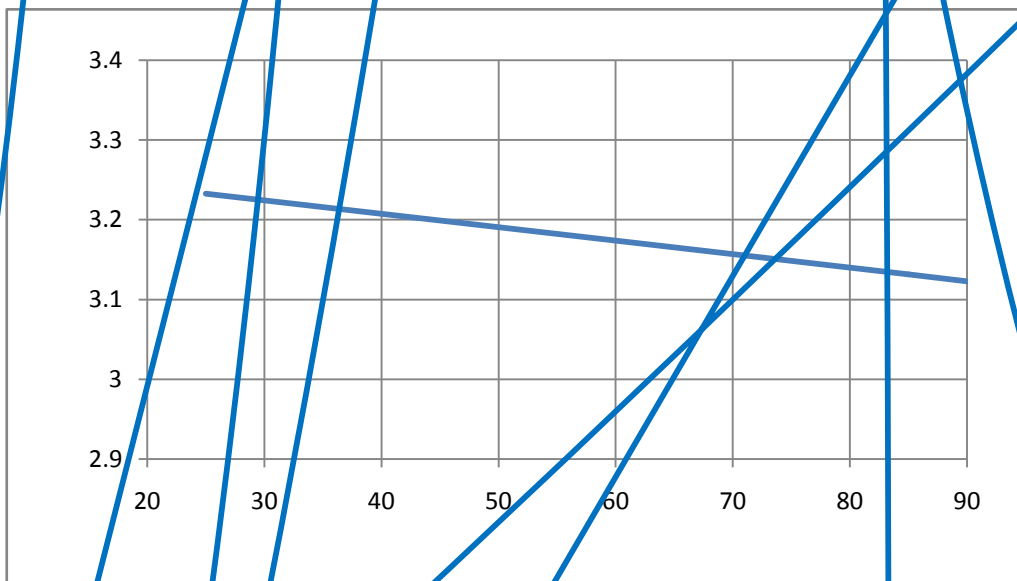

Fig 1-12 Forward Voltage Vs Solder Temperature

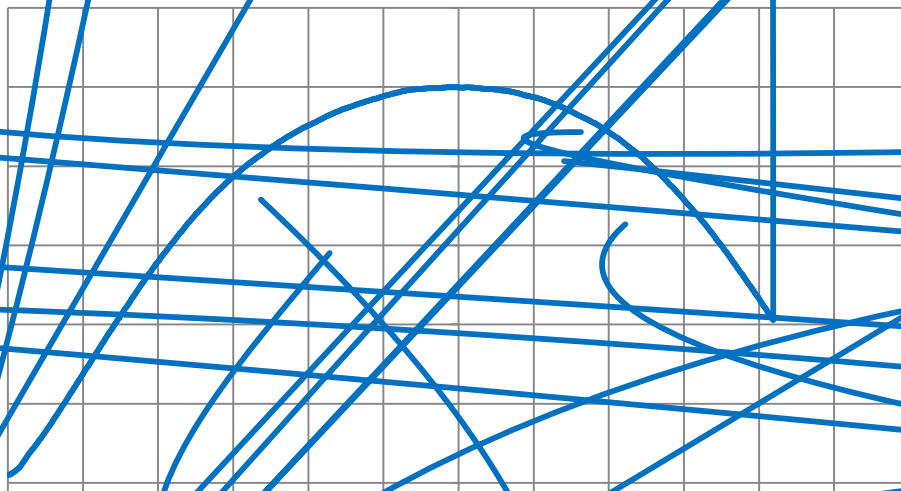

Fig 1-13 Radiation diagram

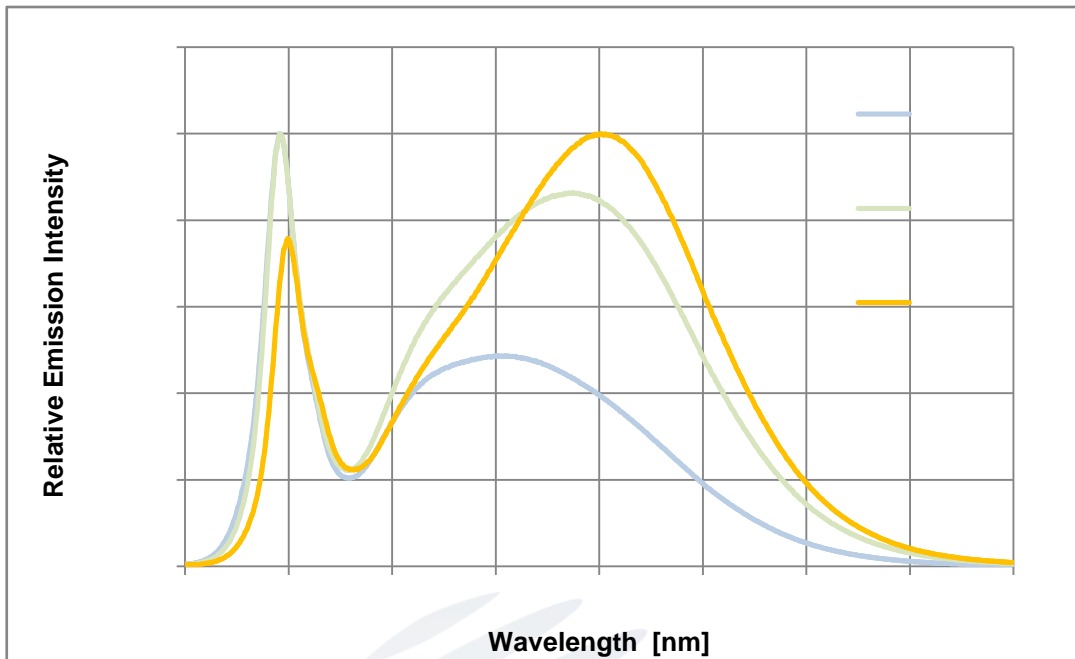
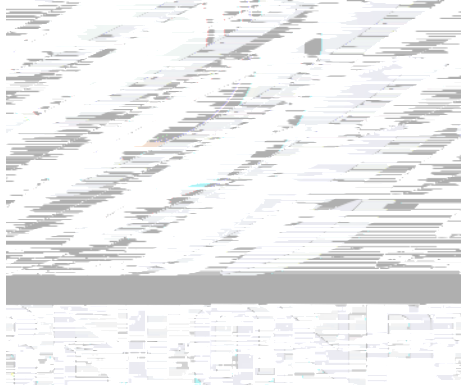

Fig 1-14 Spectrum Distribution



2. Packaging

2.1 Packaging Specification

Package: Max 3000pcs/reel I.

3000pcs

2.1.1 Carrier Tape Dimension

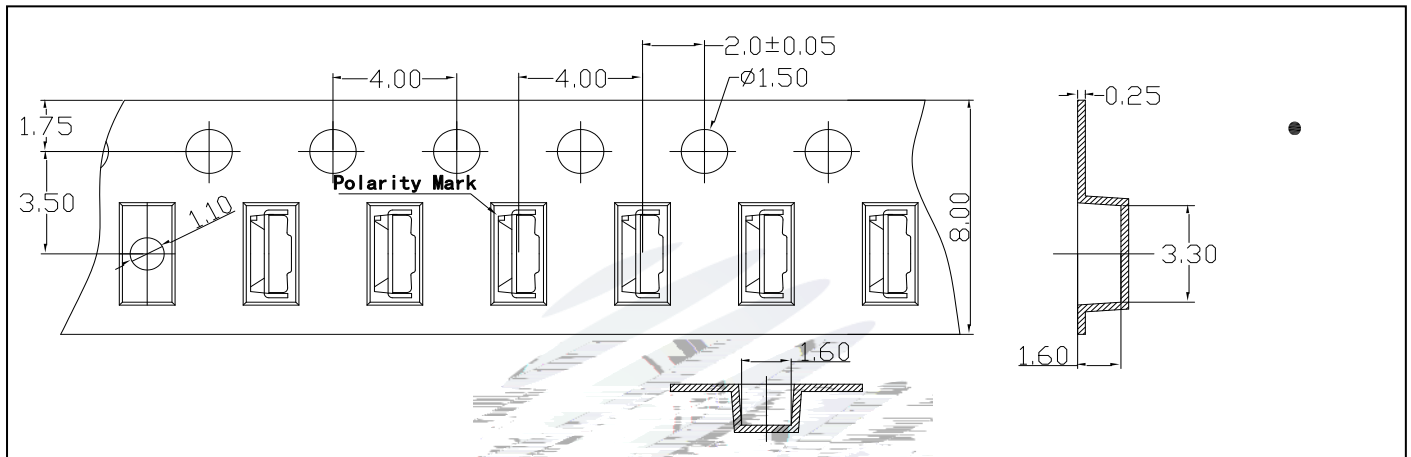

Fig.2-1 Carrier Tape Dimension

2.1.2 Reel Dimension

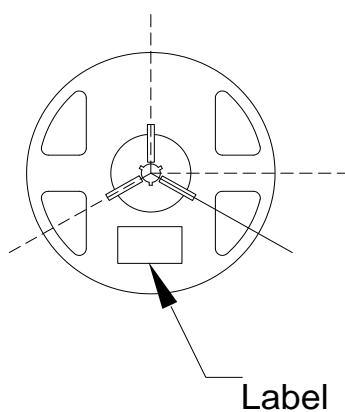

Fig.2-2

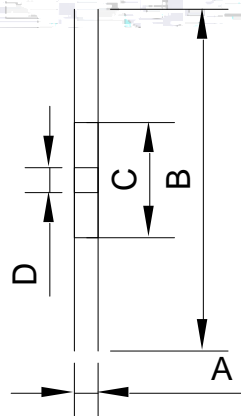

Table 2-1

| | |
|---|------------|
| A | 11.7 0.1mm |
| B | 178 1mm |
| C | 58.5 1mm |
| D | 13.5 0.5mm |

Notes

The tolerances unless mentioned ± 0.1 mm. Unit : mm 注：未注公差为 ± 0.1 毫米 尺寸单位：毫米

2.1.3 Label Form Specification

Table 2-2 Label Parameter

| | |
|----------|-------------|
| PART NO. | Part Number |
| SPEC NO. | Spec Number |

2.2 Moisture Resistant Packing

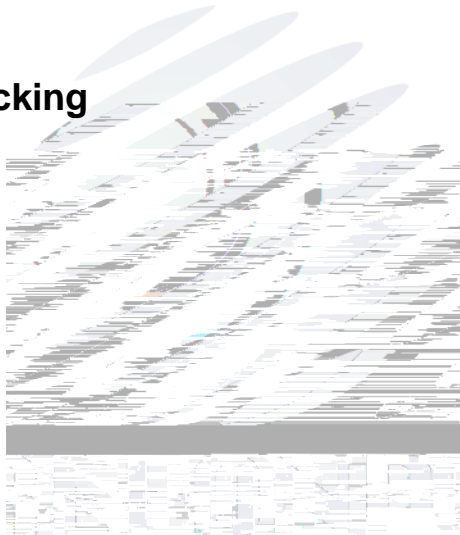
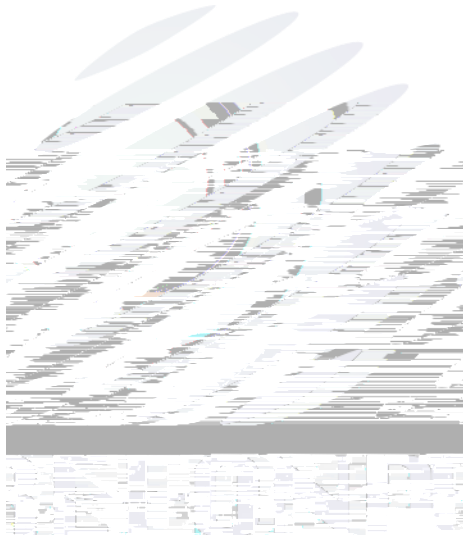

Fig.2- Packing specification

2.3 Cardboard Box

Fig.2- Cardboard Box



2.5 Criteria For Judging Damage

Table 2-4 Criteria for judging damage

| Test Items | Symbol | Test Condition | Criteria For Judgement | Applicable project |
|----------------------|--------|----------------|---|---|
| Forward Voltage | V_F | $I_F=20mA$ | 10% | Reflow Thermal Shock |
| Luminous Flux | | $I_F=20mA$ | Maintenance 90% 90% | High and Low Temperature Storage Life Test |
| Lamp Bead Light Test | / | $I_F=20mA$ | No open circuit short circuit or flicke | High Temperature High Humidity Life Test |

Notes

- 1.U.S.L: Upper standard level
L.S.L: Lower standard level
2. The above reliability tests is based on the verification of a single/strip LED of Refond's existing experimental platform, the reliability experiment was taken under good heat dissipation conditions. when customers applies the LED to the series and parallel circuit, should take consideration of all the factors such as the current, voltage distribution, heat dissipation and others. / LED
3. The technical information shown in the data sheets are limited to the typical characteristics and circuit examples of the referenced products. It does not constitute the warranting of industrial property nor the granting of any license.

3. SMT Reflow Soldering Instructions SMT

3.1 SMT Reflow Soldering Instructions SMT

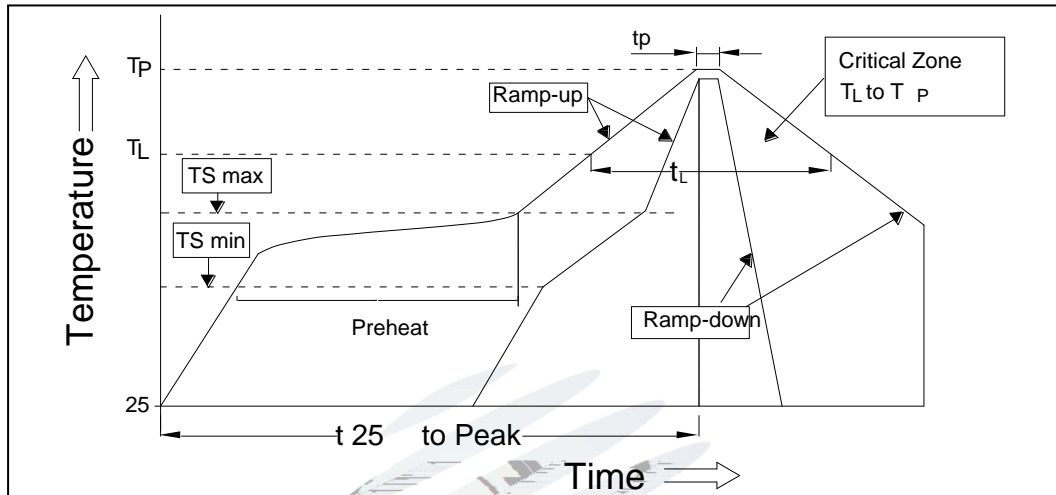

Fig.3-1 SMT Reflow Soldering Instructions SMT

Table 3-1 SMT Reflow Soldering Parameter SMT

| | | |
|--|-----------------------|----------------------|
| Average temperature rise speed | T_{smax} T_P | Max 3 °C/ s 3 °C/ |
| Preheating: minimum temperature | (T_{smin}) | 150 °C |
| Preheating: Max temperature | (T_{smax}) | 200 °C |
| Preheating: Time | T_{smin} T_{smax} | 60s-120s |
| Time limited to maintain high temperature: the temperature | (T_L) | 217 °C |
| Time limited to maintain high temperature: The Time | (t_L) | Max 60s 60 |
| Peak /Classification of temperature: | (T_P) | 260 °C |
| Time limit classification of peak temperature time | t_p | Max 10s 10 |
| Hold time within 5 °C with the actual peak temperature (T_P) 5 °C | (T_P) | Max 30s 30 |
| Cooling speed | | Max 6 °C/ s 6 °C/ |
| Needed time from 25 °C to T_p 25 °C | | Max 8 minutes 8 |

Notes

(1) Reflow soldering should not be done more than two times. In the case of more than 24 hours passed soldering after first, LEDs will be damaged. 24

LED

(2) When soldering , do not put stress on the LEDs during heating.

3.1.1 Soldering Iron

(1) When hand soldering, keep the temperature of iron below less 300 less than 3 seconds
300 3

(2) The hand solder should be done only one time.

3.1.2 Repairing

Repair should not be done after the LEDs have been soldered. When repairing is unavoidable,a double-head soldering iron should be used (as below figure). It should be confirmed in advance whether the characteristics of LEDs will or will not be damaged by repairing.

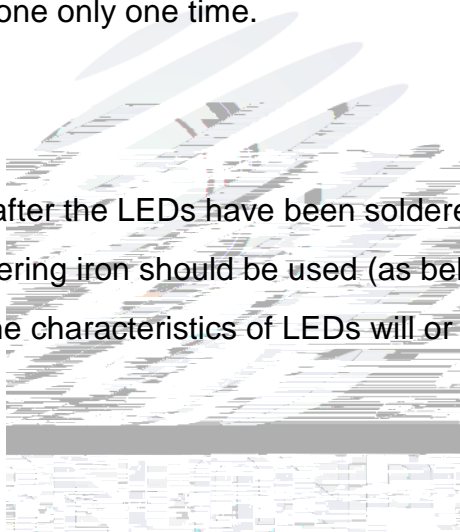

LED

LED

3.1.3 Cautions

(1) The encapsulated material of the LEDs is silicone. Therefore the LEDs have a soft surface on the top of package. The pressure to the top surface will be influence to the reliability of the LEDs. Precautions should be taken to avoid the strong pressure on the encapsulated part. So when use the picking up nozzle, the pressure on the silicone resin should be proper. LED

LED

(2) Components should not be mounted on warped (non coplanar) portion of PCB. After soldering, do not warp the circuit board.LED PCB

(3) Do not apply mechanical force or excess vibration during the cooling process to normal temperature after soldering. Do not rapidly cool device after soldering.

4. Handling Precautions

4.1 Handling Precautions

(1) LED operating environment and sulfur element composition cannot be over 100PPM in the LED mating usage material. This is provided for informational purposes only and is not a warranty or endorsement.

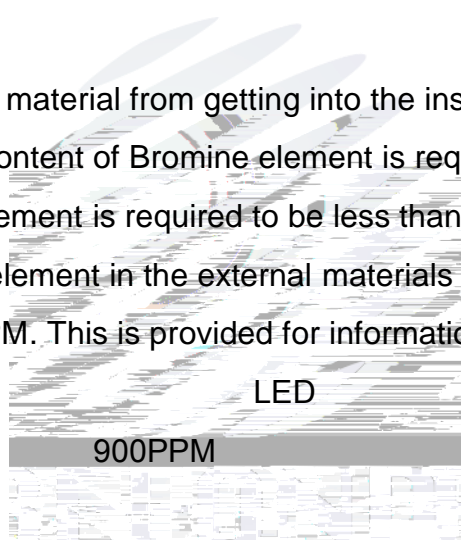

(2) In order to prevent external material from getting into the inside of LED, which may cause the malfunction of LED, the single content of Bromine element is required to be less than 900PPM, the single content of Chlorine element is required to be less than 900PPM, the total content of Bromine element and Chlorine element in the external materials of the application products is required to be less than 1500PPM. This is provided for informational purposes only and is not a warranty or endorsement.

1500PPM.

(3) VOCs (Volatile organic compounds) emitted from materials used in the construction of fixtures can penetrate silicone encapsulants of LEDs and discolor when exposed to heat and photonic energy. The result can be a significant loss of light output from the fixture. Knowledge of the properties of the materials selected to be used in the construction of fixtures can help prevent these issues. Refond advises against the use of any chemicals or materials that have been found or are suspected to have an adverse affect on device performance or reliability. To verify compatibility, Refond recommends that all chemicals and materials be tested in the specific application and environment for which they are intended to be used. Attaching LEDs, do not use adhesives that outgas organic vapor.

LED
LED

LED

(4) Handle the component along the side surface by using forceps or appropriate tools; do not directly touch or Handle the silicone lens surface, it may damage the internal circuitry.

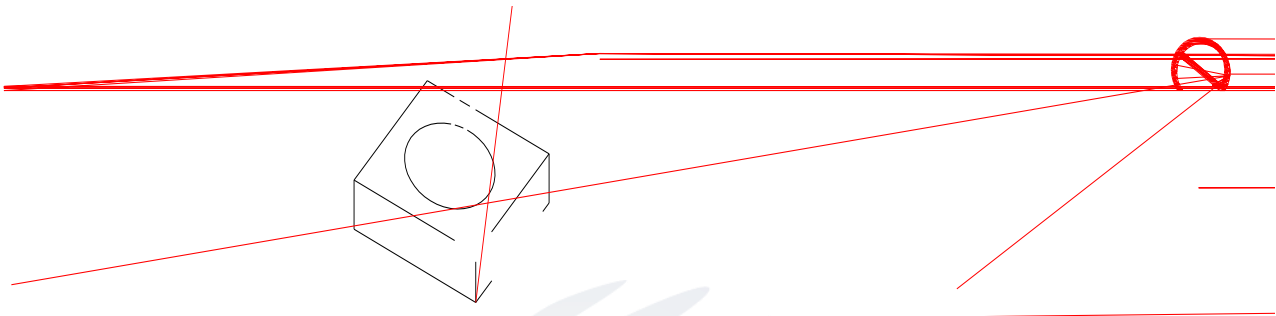

Fig 4-1. Misoperation

(5) In designing a circuit, the current through each LED must not exceed the absolute maximum rating specified for each LED. In the meanwhile, resistors for protection should be applied, otherwise slight voltage shift will cause big current change, burn out may happen. The driving circuit must be designed to allow forward voltage only when it is ON or OFF. If the reverse voltage is applied to LED, migration can be generated resulting in LED damage.

LED

LED

(6) Thermal Design is paramount importance because heat generation may result in the Characteristics decline, such as brightness decreased, Color change and so on. Please consider the heat generation of the LEDs when making the system design. LED

LED

(7) Compared to standard encapsulants, silicone is generally softer, and the surface is more likely to attract dust, requiring special care during processing. In cases where a minimal level of dirt and dust particles cannot be guaranteed, a suitable cleaning solution must be applied to the surface after the soldering of components. Refond suggests using isopropyl alcohol for cleaning.

In case other solvents are used, it must be assured that these solvents do not dissolve the package or resin. Ultrasonic cleaning is not recommended. Ultrasonic cleaning may cause damage to the LED.

LED

Table 4-1 Storage

| Conditions | | Temperature | Humidity | Time |
|------------|-----------------------------|-------------|----------|-------------------------|
| Storage | Before Opening Aluminum Bag | 30 | 75% | Within 1 Year From Date |
| | After Opening Aluminum Bag | 30 | 60% | 24hours 24 |
| Baking | | 60 ± 5 | | 24hours 24 |

(8) If the moisture absorbent material(silica gel)has faded away or the LEDs have exceeded the storage time , baking treatment should be performed after unpacking and based on the following condition(60±5) for above 24 hours.

60 ± 5 24

If the package is flatulence or damaged,please notify the sales staff to assist.

(9) Similar to most Solid state devices; LEDs are sensitive to Electro-Static Discharge (ESD) and Electrical Over Stress (EOS).

LED

(10) Other points for attention, please refer to our relevant information.



Declare

This specification is written both in English and in Chinese and the latter is formal.