

# SPECIFICATION

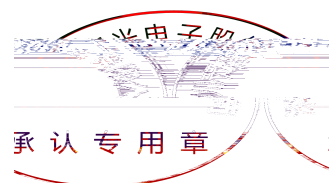

## Contents

- 1. Description
  - 1.1 General Description
  - 1.2 Features
  - 1.3 Application
  - 1.4 Package Dimension

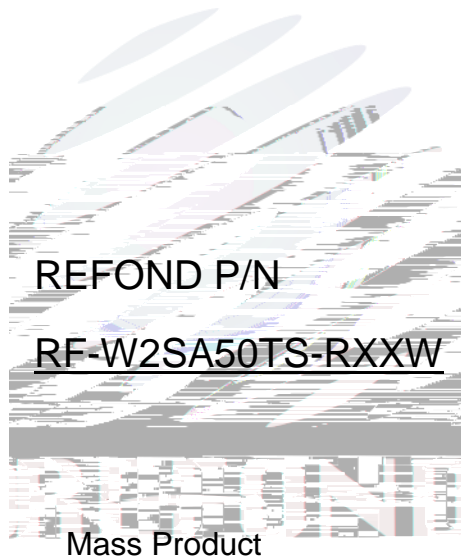



### 1.3 Application

Article color lamp, lamp belt.

Landscape lighting, Trademark logo.

Hotels, markets, offices, household and other architectural uses.

General use.

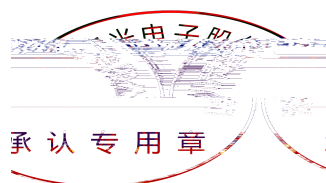

### 1.4 Package Dimension

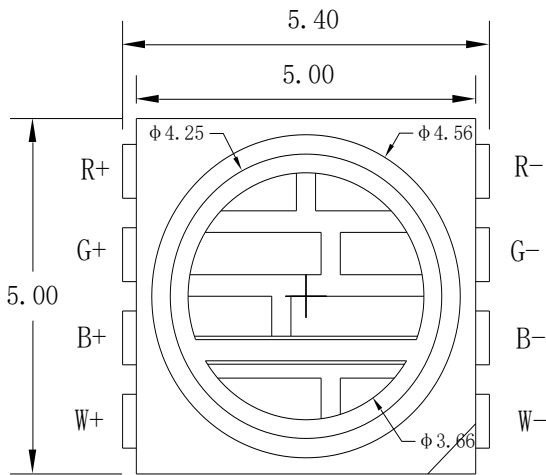

Fig.1-1 Top view

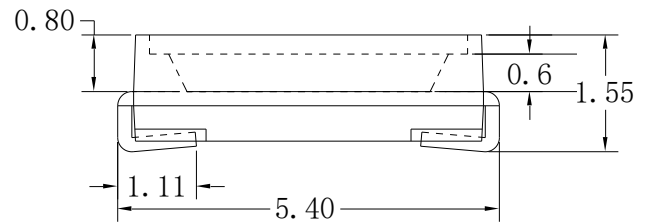

Fig.1-2 Side view

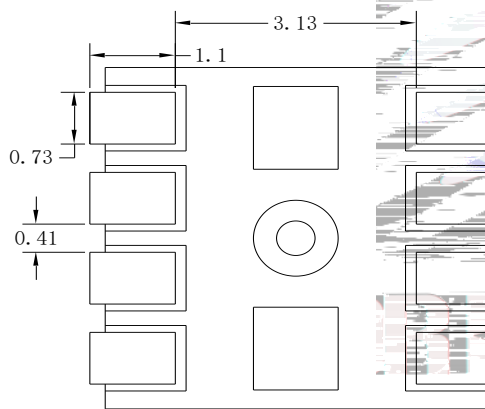

Fig.1-3 Bottom view

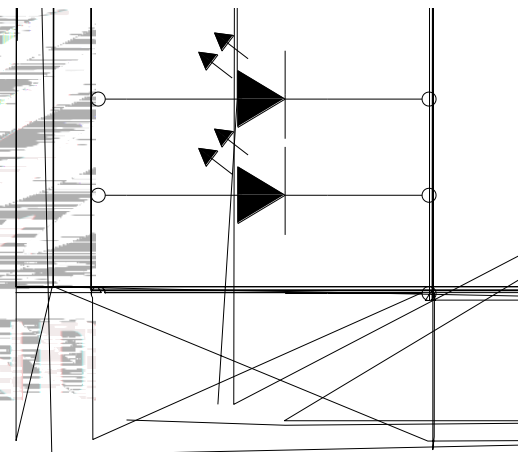

Fig.1-4 Polarity

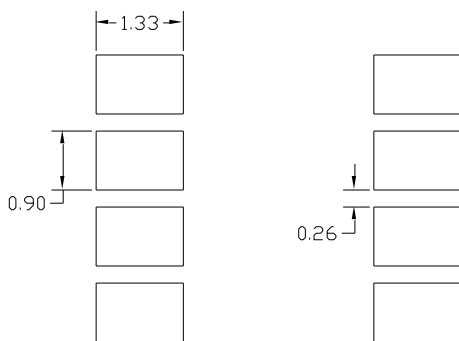

Fig.1-5 Soldering patterns



Notes

, ) All dimensions units are millimeters.

- ) All dimensions tolerances are  $\pm 0.2\text{mm}$  unless otherwise noted.

### 1.5 Product Parameters

Table 1-1 Electrical / Optical Characteristics at  $T_s=25^\circ\text{C}$

Item	Symbol	Test Condition	Value			Unit
			Min.	Typ	Max.	
Forward Voltage R	$V_F$	$I_F=20\text{mA}$	2.0	---	2.3	V
Forward Voltage G			2.95	---	3.25	V
Forward Voltage B			2.85	---	3.25	V
Forward Voltage W			2.75	---	3.05	V
Luminous Intensity R						

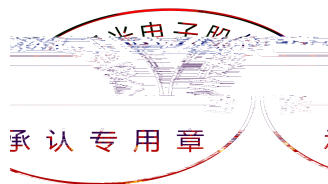

Thermal Resistance W			---	75	---	/W
----------------------	--	--	-----	----	-----	----

Table 1-2 Absolute Maximum Ratings at Ts=25°C

Parameter	Symbol	Rating	Units
Power Dissipation	$P_D$	293.75	mW
Forward Current	$I_F$	R/G/B/W 25	mA
Peak Forward Current	$I_{FP}$	80	mA
Reverse Voltage	$V_R$	5	V
Electrostatic Discharge (HBM)	$E_{SD}$	2000	V
Operating Temperature	$T_{OPR}$	-40 ~ +85	
Storage Temperature	$T_{OPR}$	-40 ~ +85	
Junction Temperature R	$T_J$	94	
Junction Temperature G	$T_J$	94	
Junction Temperature B	$T_J$	94	
Junction Temperature W	$T_J$	93	

Notes

- 1/10 Duty cycle, 0.1ms pulse width. ( , , )
- The above forward voltage measurement allowance tolerance is  $\pm 0.1V$ .
- The above wavelength measurement allowance tolerance is  $\pm 1nm$ . ( $\pm 1nm$ )
- The above color coordinates measurement allowance tolerance is  $\pm 0.005$ . ( ) 0)





5. The above luminous intensity measurement allowance tolerance  $\pm 10\%$ .
6. The above color rendering index measurement allowance tolerance is  $\pm 1$ .
7. Care is to be taken that power dissipation does not exceed the absolute maximum rating of the product.
8. All measurements were made under the standardized environment of Refond.
9. When the LEDs are in operation the maximum current should be decided after measuring the package temperature (junction temperature should not exceed the maximum rate)
10. ESD yield is over 80% at 2000V ESD (HBM). ESD protection during products handling is needed.

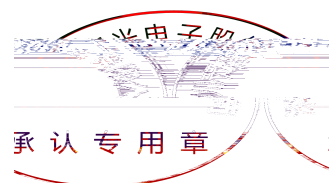

### 1.5.1 Bin Range Of Forward Voltage and Luminous Intensity (IF=20mA)

**BIN (IF=20mA)**

Table 1-3

		B	v
Forward Voltage R	$V_F$	V R	Rv
			2.0-2.3
Forward Voltage G	$V_F$	V G	Gv
			2.95-3.25
Forward Voltage B	$V_F$	V B	Bv



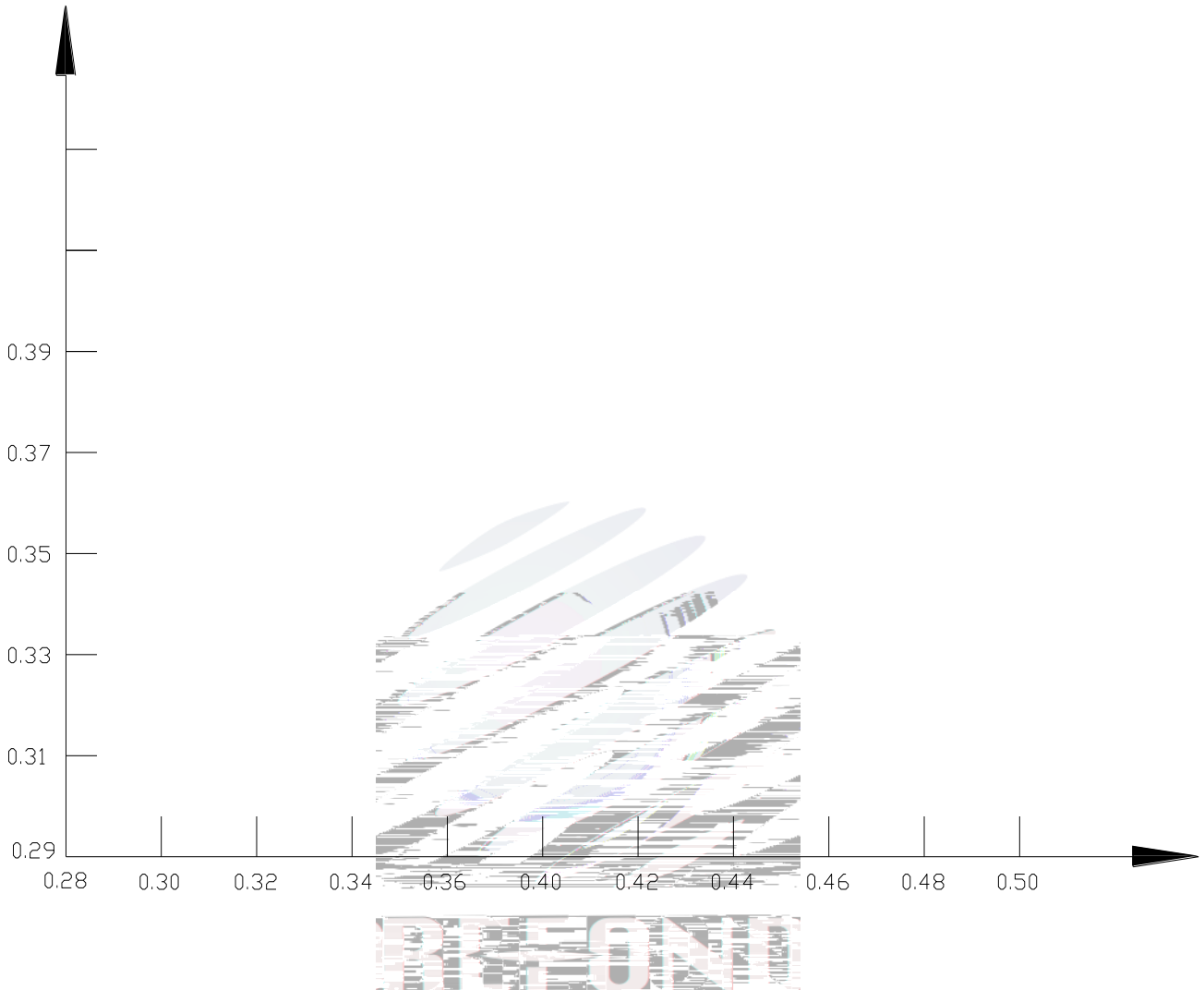
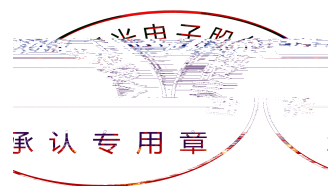

Fig 1-6 The C.I.E Chromaticity Diagram CIE



## 1.5.2 BIN and parameter comparison table BIN

Table 1-4

Bin code	XY	VF-W	VF-G	VF-R	VF-B	IV-W	IV-G	IV-R	IV-B	WLD-G	WLD-R
----------	----	------	------	------	------	------	------	------	------	-------	-------



## 1.6 Typical optical characteristics curves

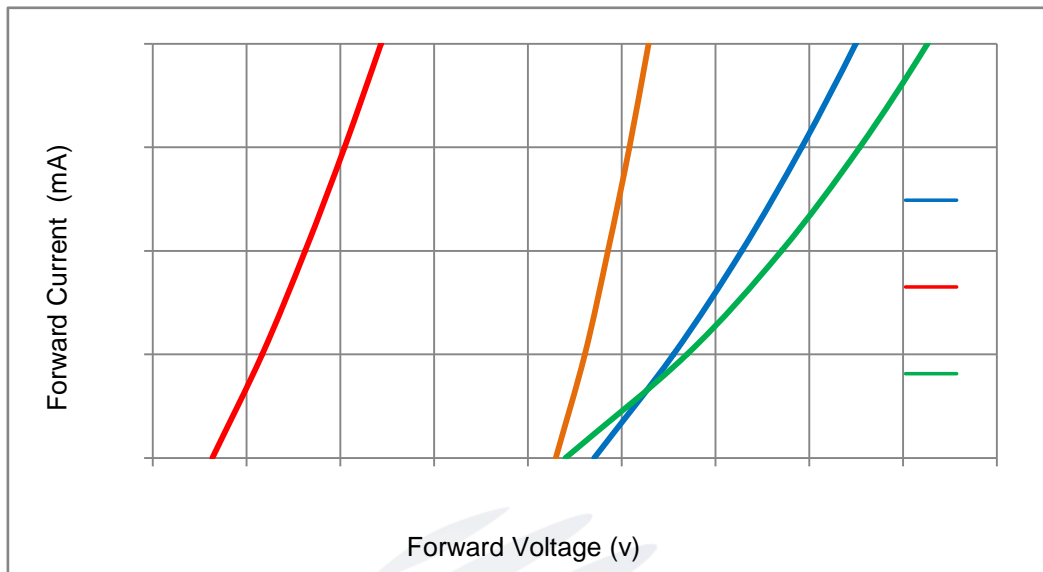

Fig 1-7 Forward Voltage Vs. Forward Current

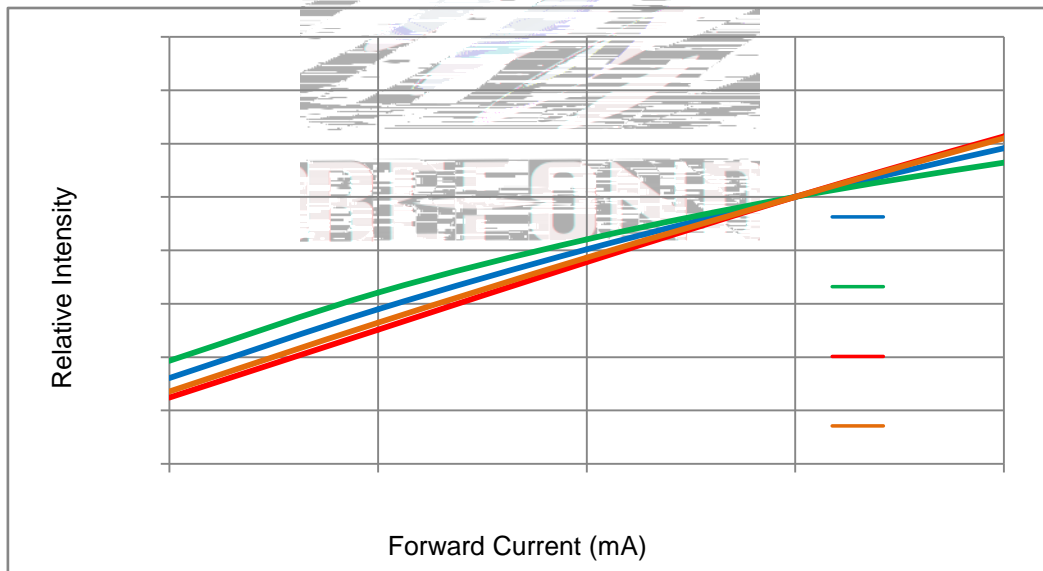
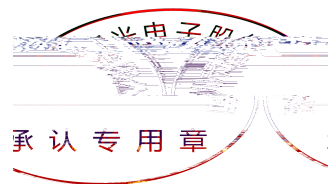

Fig 1-8 Forward Current Vs. Relative Intensity



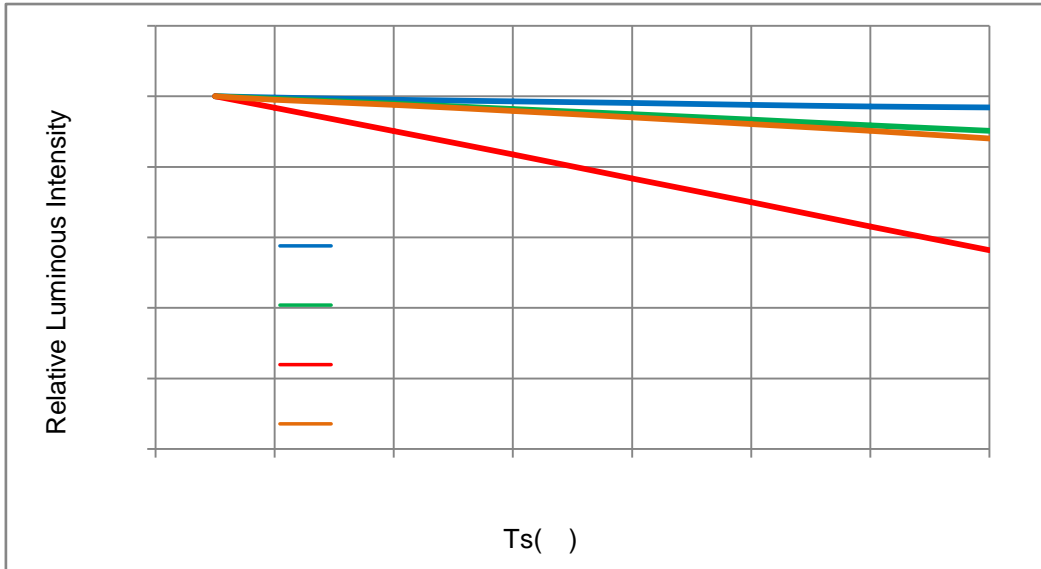

Fig 1-9 Solder Temperature Vs Relative Intensity

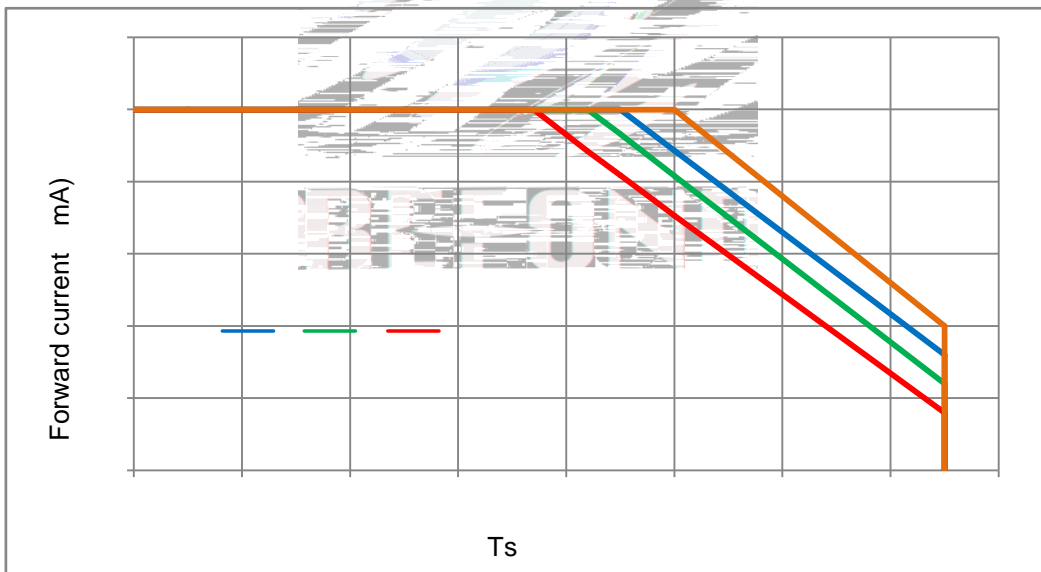

Fig 1-10 Solder Temperature Vs Forward Current

光中  
R&C&B Tj: 94  
W1 Tj: 93  
承认专用章

Fig 1-11 Forward Voltage Vs Solder Temperature

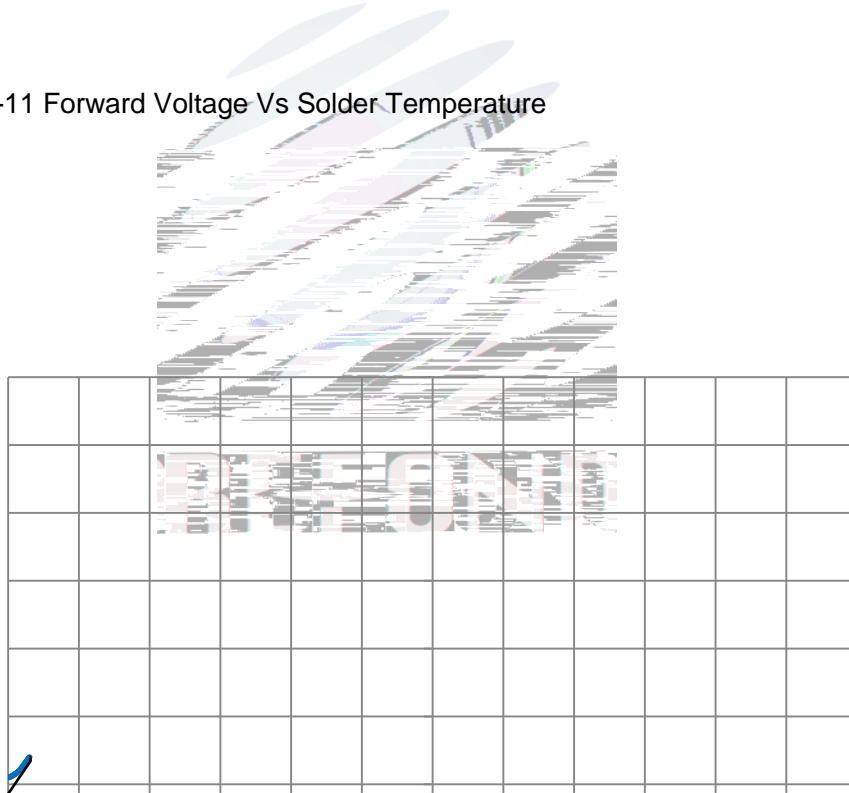
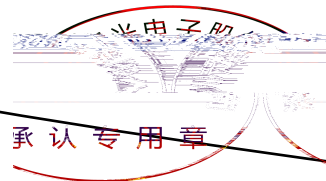
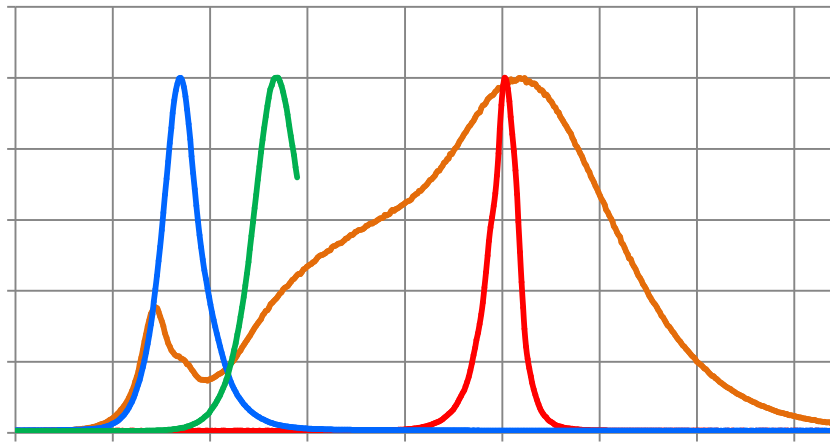

Fig 1-12 Radiation diagram







## 2. Packaging

### 2.1 Packaging Specification

Package:1000pcs/reel.

#### 2.1.1 Carrier Tape Dimension

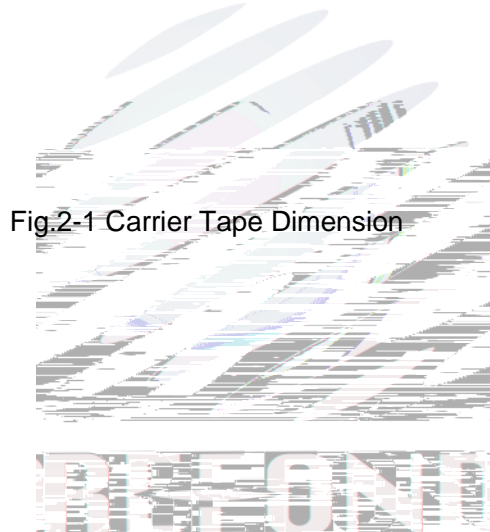

Fig.2-1 Carrier Tape Dimension

#### 2.1.2 Reel Dimension



-(,

Fig.2-2 Reel

Notes

### 2.1.3 Label Form Specification

-(-

<b>PART NO.</b> cinvcode	
<b>SPEC NO.</b> cspecno	
<b>LOT NO.</b> lotno	
<hr/>	
<b>BIN CODE</b>	
<b>XY:</b>	
	<b>QTY:</b>
	<b>DATE:</b>

PART NO.	Part Number
SPEC NO.	Spec Number
LOT NO.	Lot Number
BIN CODE	Bin Code
XY	Chromaticity Bin
QTY	Packing Quantity
DATE	Made Date

Fig 2-3 Label Form

### 2.2 Moisture Resistant Packing

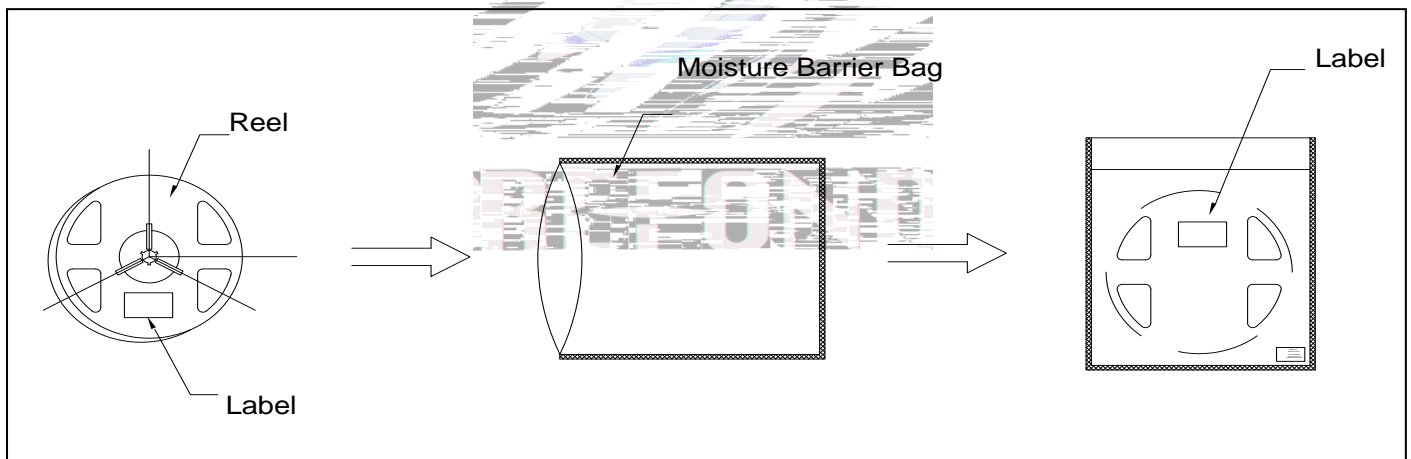
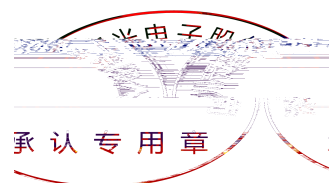

Fig.2-4 Packing specification



## 2.3 Cardboard Box

Fig.2-2 Cardboard Box

## 2.4 Reliability Test Items And Conditions

Table 2-3 Test items and conditions

Test Items	Ref. Standard	Test Condition	Time	Quantity	Ac/Re
Reflow	JESD22-B106	T <sub>emp</sub> :260 max T=10 sec	2times.	10pcs.	0/1
Thermal Shock	JEITAED-4701 300307	-40 15min 10s 100 15min	100 cycle.	10pcs.	0/1
	200 201	Temp:100	1000hrs.		

High Temperature High Humidity Life Test	JESD22-A101	60 / 90%RH I <sub>F</sub> =20mA	500hrs.	10pcs.	0/1
---	-------------	------------------------------------	---------	--------	-----

## 2.5 Criteria For Judging Damage

Table 2-4 Criteria for judging damage

Test Items	Symbol	Test Condition	Criteria For Judgement	Applicable project
Forward Voltage		8-		Reflow Thermal Shock High and Low Temperature Storage Life Test
Luminous Intensity	I <sub>v</sub>	8-	Maintenance 70%	
Luminous Intensity			Maintenance 70%	
Luminous Intensity =			Maintenance 50%	
Luminous Flux W		8-	Maintenance 88%	
Lamp Bead Light Test		8-	No open circuit short circuit or flicke	

### Notes

1.The above reliability tests is based on the verification of a single/strip LED of Refond's existing experimental platform,the reliability experiment was taken under good heat dissipation conditions. when customers applies



the LED to the series and parallel circuit, should take consideration of all the factors such as the current, voltage distribution, heat dissipation and others.

2.The technical information shown in the data sheets are limited to the typical characteristics and circuit examples of the referenced products. It does not constitute the warranting of industrial property nor the granting of any license.

### 3. SMT Reflow Soldering Instructions SMT

#### 3.1 SMT Reflow Soldering Instructions SMT

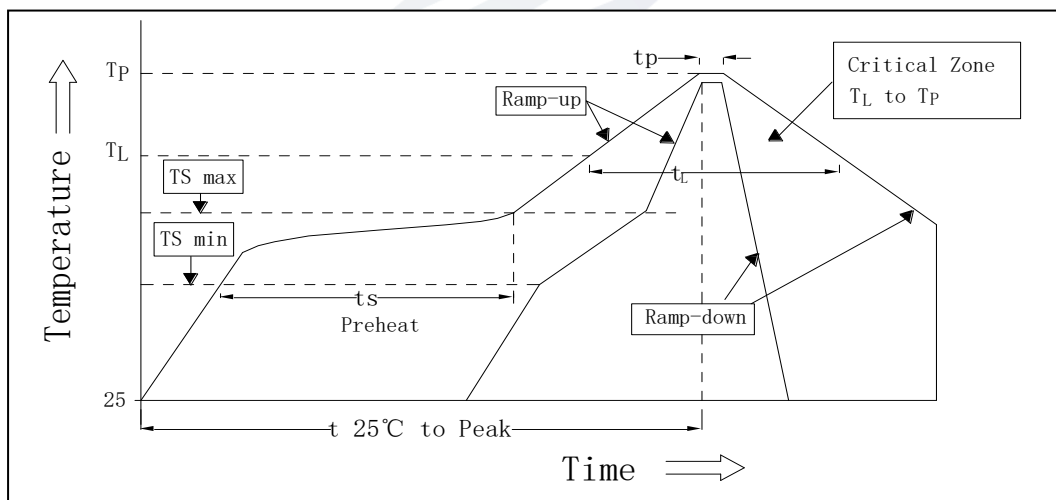

Fig.3-1 SMT Reflow Soldering Instructions SMT

Table 3-1 SMT Reflow Soldering Parameter SMT

Average temperature rise speed	Tsmax	TP	Max 3 °C/ s	3 °C/
Preheating: minimum temperature	(T Amin)		150 °C	
Preheating: Max temperature	(T Amax)		200 °C	
Preheating: Time	T Amin	T Amax	60 - 120	60s-120s
Time limited to maintain high temperature: the temperature (TL)			217 °C	

Time limited to maintain high temperature: The Time ( $t_L$ )	Max 60s      60
Peak /Classification of temperature:      /      ( $T_P$ )	260 °C
Time limit classification of peak temperature time $t_p$	Max 10s      10
Hold time within 5 °C with the actual peak temperature ( $T_P$ ) ( $T_P$ )      5 °C	Max 30s      30
Cooling speed	Max 6 °C/ s      6 °C/
Needed time from 25 °C to $T_p$ 25 °C	Max 8 minutes      8

Notes

(1)Reflow soldering should not be done more than twice. If more than 24 hours between the two solderings , LED will be damaged.

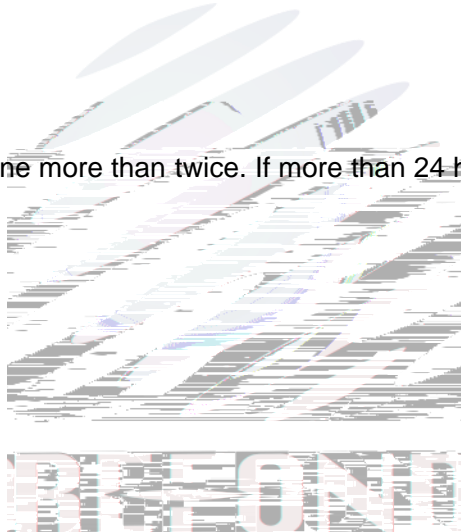

- /

### 3.1.3 Cautions

(1) The encapsulated material of the LEDs is silicone. Therefore the LEDs have a soft surface on the top of package. The pressure to the top surface will be impacted on the reliability of the LEDs. Precautions should be taken to avoid the strong pressure on the encapsulated part. So when use the picking up nozzle, the pressure on the silicone resin should be proper. LED

(2) Components should not be mounted on warped (non coplanar) portion of PCB. After soldering, do not warp the circuit board. LED =

(3) Do not apply mechanical force or excess vibration during the cooling process to normal temperature after soldering. Do not rapidly cool device after soldering.

## 4. Handling Precautions

### 4.1 Handling Precautions

(1) LED operating environment and sulfur element composition cannot be over 100PPM in the LED mating usage material. This is provided for informational purposes only and is not a warranty or endorsement. LED , )

(2) In order to prevent external material from getting into the inside of LED, which may cause the malfunction of LED, the single content of Bromine element is required to be less than 900PPM, the single content of Chlorine element is required to be less than 900PPM, the total content of Bromine element and Chlorine element in the external materials of the application products is required to be less than 1500PPM. This is provided for informational purposes only and is not a warranty or endorsement.

4

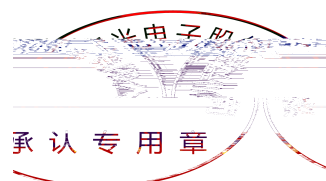

4

, 0 )





(6) Thermal Design is paramount importance because heat generation may result in the Characteristics decline, such as brightness decreased, Color change and so on. Please consider the heat generation of the LEDs when making the system design. LED

(7) Compared to standard encapsulants, silicone is generally softer, and the surface is more likely to attract dust, requiring special care during processing. In cases where a minimal level of dirt and dust particles cannot be guaranteed, a suitable cleaning solution must be applied to the surface after the soldering of components. Refond suggests using isopropyl alcohol for cleaning. In case other solvents are used, it must be assured that these solvents do not dissolve the package or resin. Ultrasonic cleaning is not recommended. Ultrasonic cleaning may cause damage to the LED.

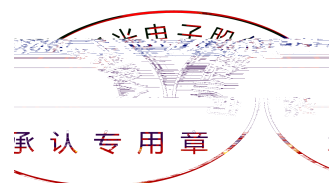
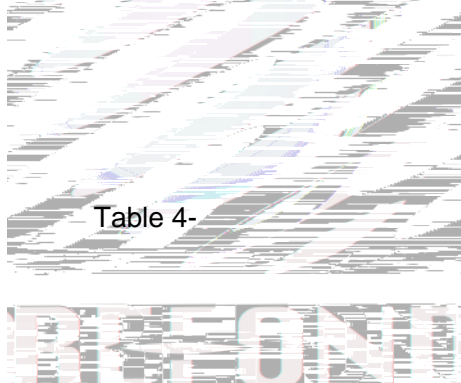

(8) If the moisture absorbent material silica gel has faded away or the LEDs have exceeded the storage time, baking treatment should be performed after unpacking and based on the following condition 60 5 for above 24 hours.

1 0 - /

If the package is flatulence or damaged, please notify the sales staff to assist.

(9) Similar to most Solid state devices; LEDs are sensitive to Electro-Static Discharge (ESD) and Electrical Over Stress (EOS).

(10) Other points for attention, please refer to our relevant information.

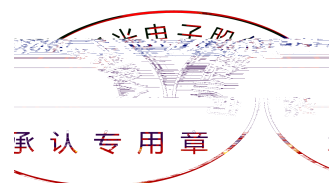





Declare

This specification is written both in English and in Chinese and the latter is formal.