

# SPECIFICATION 产品规格书

REFOND P/N 产品型号

RF-AL-E3030L2K0DR-00

R&D 研发

Mass Product 量产供货

## Contents 目錄

1. Description 产品介绍.....	3
1.1 General Description 产品描述.....	3
1.2 Features 产品特征.....	3
1.3 Application 产品应用.....	3
1.4 Package Dimension 封装尺寸.....	4
1.5 Product Parameters 产品参数.....	5
1.6 Typical optical characteristics curves 典型光学特性曲线.....	7
2. Packaging 产品包装.....	10
2.1 Packaging Specification 包装规格.....	10
2.1.1 Carrier Tape Dimension 载带尺寸.....	10
2.1.2 Reel Dimension 卷盘尺寸.....	10
2.1.3 Label Form Specification 标签规格.....	11
2.3 Cardboard Box 包装纸箱.....	11
2.4 Reliability Test Items And Conditions 信赖性测试项目及条件.....	12
2.5 Criteria For Judging Damage 失效判定标准.....	13
3. SMT Reflow Soldering Instructions SMT 回流焊说明.....	14
3.1 SMT Reflow Soldering Instructions SMT 回流焊说明.....	14
4. Handling Precautions 产品使用注意事项.....	16
4.1 Handling Precautions 产品使用注意事项.....	16

## 1. Description 产品介绍

### 1.1 General Description 产品描述



This product uses the EMC Molding package, it has a high reliability. it also be widely application for Grow Lamps, such as flower production, tissue culture, plant factory, greenhouse and refreshment.

Size(mm): 3.00mmX3.00mmX2.10mm.

本产品采用EMC Molding封装结构，可靠性高。广泛应用于各种植物照明器中，如花卉生产、组织培养，植物工厂，温室蔬菜与水果，冰箱保鲜。

产品尺寸：3.00mmX3.00mmX2.10mm.

### 1.2 Features 产品特征

Size(mm): 3.00x3.00x2.10mm. 尺寸(mm): 3.00x3.00x2.10mm

660nm. 峰值波长 660nm

Pb-free reflow soldering application. 无铅回流焊应用

Package:3000pcs/reel. 包装:每卷3000pcs

Moisture sensitive level:Level3. 防潮等级: Level 3

RoHS compliant. 符合RoHS

### 1.3 Application 产品应用

Flower production.

Tissue culture.

Plant factory.

Refreshment.

## 1.4 Package Dimension 封装尺寸

Fig.1-1 Top view 正面视图

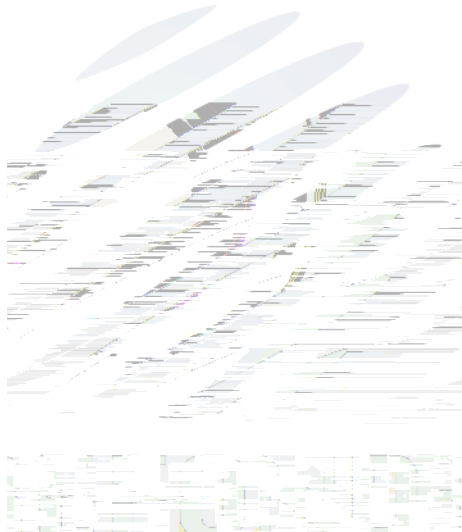

Fig.1-2 Polarity 极性

## 1.5 Product Parameters 产品参数

Table 1-1 Electrical / Optical Characteristics at Ts=25°C 电性与光学特性

Item 项目	Symbol 符号	Test Condition 测试条件	Value			Unit 单位
			Min. (最小值)	Typ (典型值)	Max. (最大值)	
Reverse Current (漏电流)	$I_R$	$V_R=5V$	---	---	10	$\mu A$
Forward Voltage (正向电压)	$V_F$	$I_F=350mA$	1.8	---	2.6	V
Peak Wavelength (峰值波长)	$\lambda_p$	$I_F=350mA$	655	660	670	nm
Total radiant flux 辐射功率	$\Phi_e$	$I_F=350mA$	230	---	530	mW
Viewing Angle (发光角度)	4	$I_F=350mA$	---	120	---	deg
Thermal Resistance. (热阻)	$R_{THJ-S}$	$I_F=350mA$	---	14	---	$^{\circ}W$

Table 1-2 Absolute Maximum Ratings at Ts=25°C 绝对最大值

Parameter (参数)	Symbol (符号)	Rating (值)	Units (单位)
Power Dissipation (功耗)	$P_D$	1.3	W
Forward Current (正向电流)	$I_F$	500	mA
Reverse Voltage (反向电压)	$V_R$	5	V
Electrostatic Discharge (HBM) (静电)	$E_{SD}$	2000	V
Operating Temperature (操作温度)	$T_{OPR}$	-40 ~ +85	
Storage Temperature (储存温度)	$T_{OPR}$	-40 ~ +100	

## Notes 备注:

- 1.1/10 Duty cycle, 0.1ms pulse width. 脉宽0.1ms,占空比1/10.
- 2.The above forward voltage measurement allowance tolerance is  $\pm 0.1V$ . 以上所示电压测量误差  $\pm 0.1V$ .
3. The above wavelength measurement allowance tolerance is  $\pm 1nm$ . 以上所示波长测量误差  $\pm 1nm$ .
4. Tolerance of measurement of Total radiant flux/ Radiant Intensity:  $\pm 10\%$ . 辐射功率/强度测量公差:  $\pm 10\%$ .
5. Care is to be taken that power dissipation does not exceed the absolute maximum rating of the product. 使用功率不能超过规定的最大值。
6. All measurements were made under the standardized environment of Refond. 所有的测试都是基于瑞丰标准测试平台。
- 7.When the LEDs are in operation the maximum current should be decided after measuring the package temperature, junction temperature should not exceed the maximum rate. LED 使用的最大电流需要根据散热条件确定, 结温不能超过最大值。

## 1.6 Typical optical characteristics curves 典型光学特性曲线

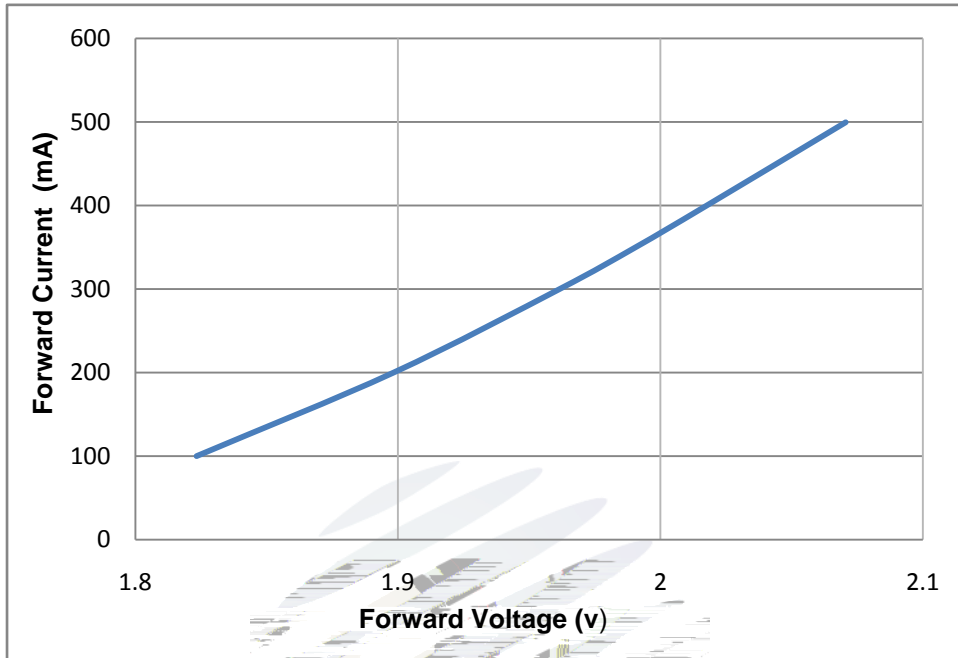

Fig 1-6 Forward Voltage Vs. Forward Current伏安特性曲线

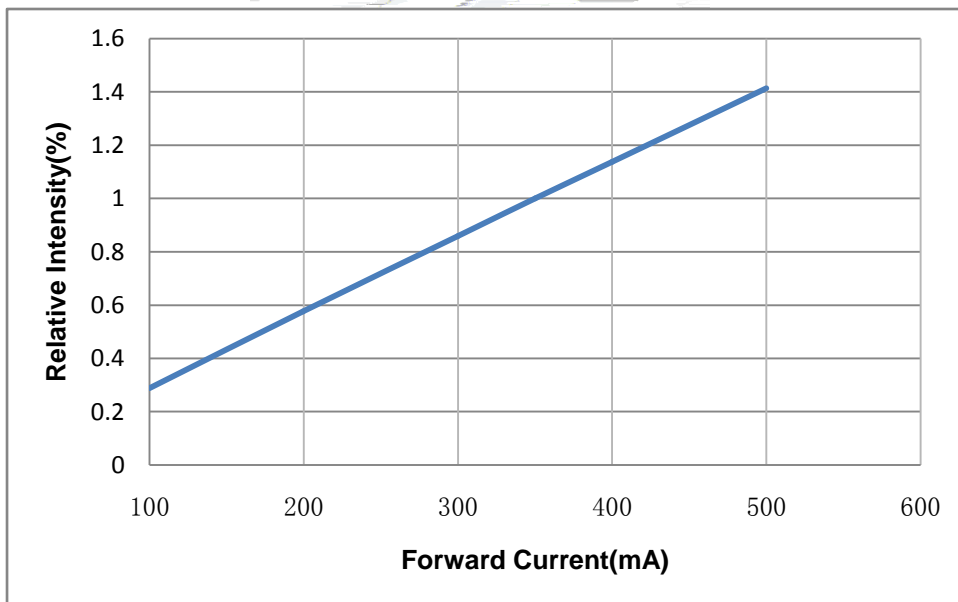

Fig 1-7 Forward Current Vs. Relative Intensity正向电流与相对光强特性曲线

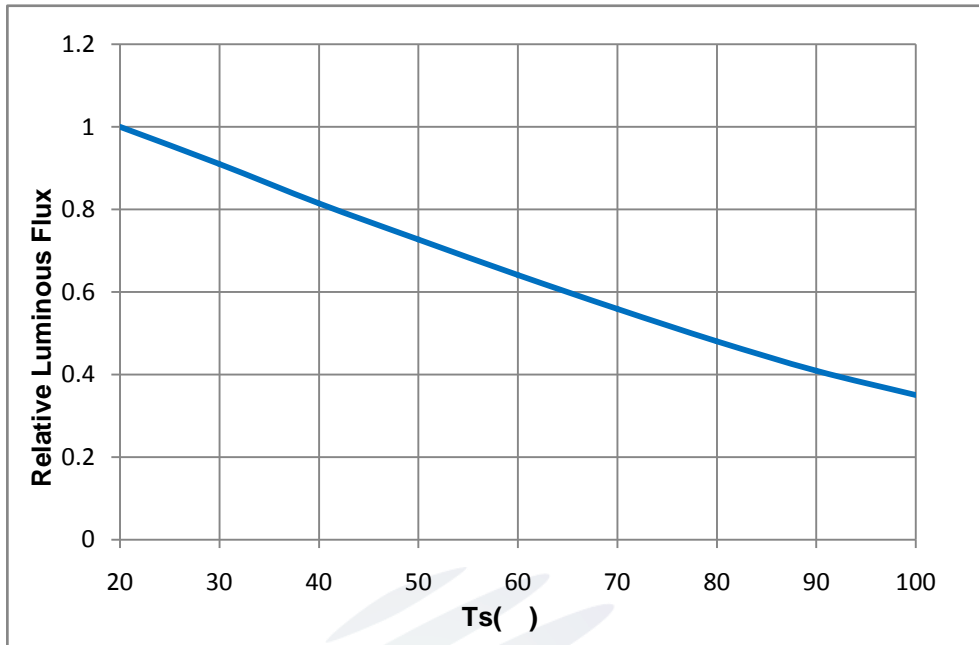

Fig 1-8 Ts Temperature Vs Relative Intensity 管脚温度与相对光强特性曲线

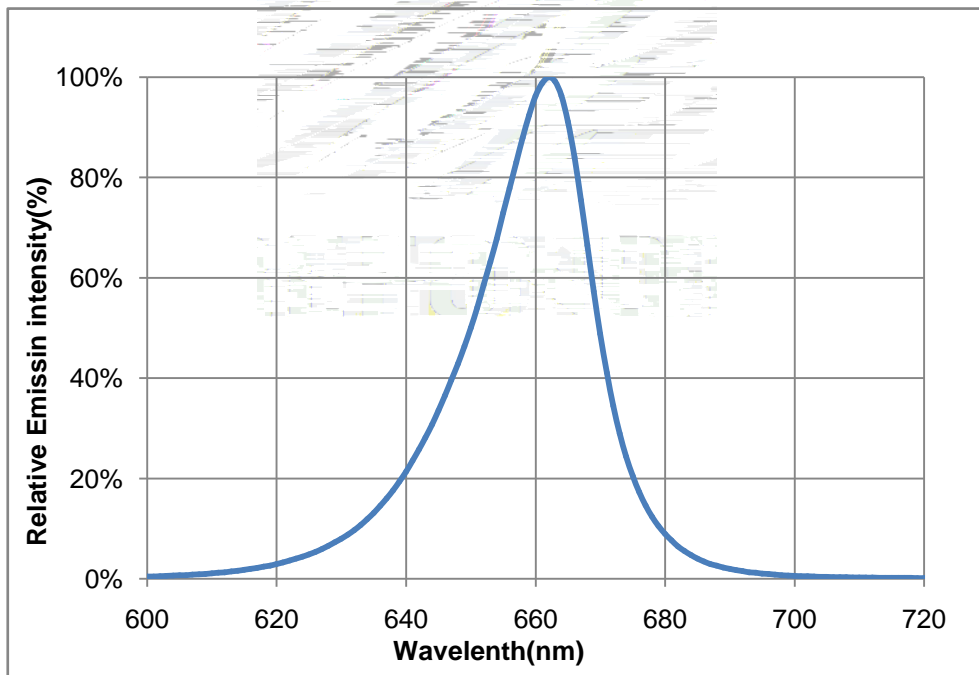

Fig 1-9 Spectrum Distribution 光谱分布特性曲线



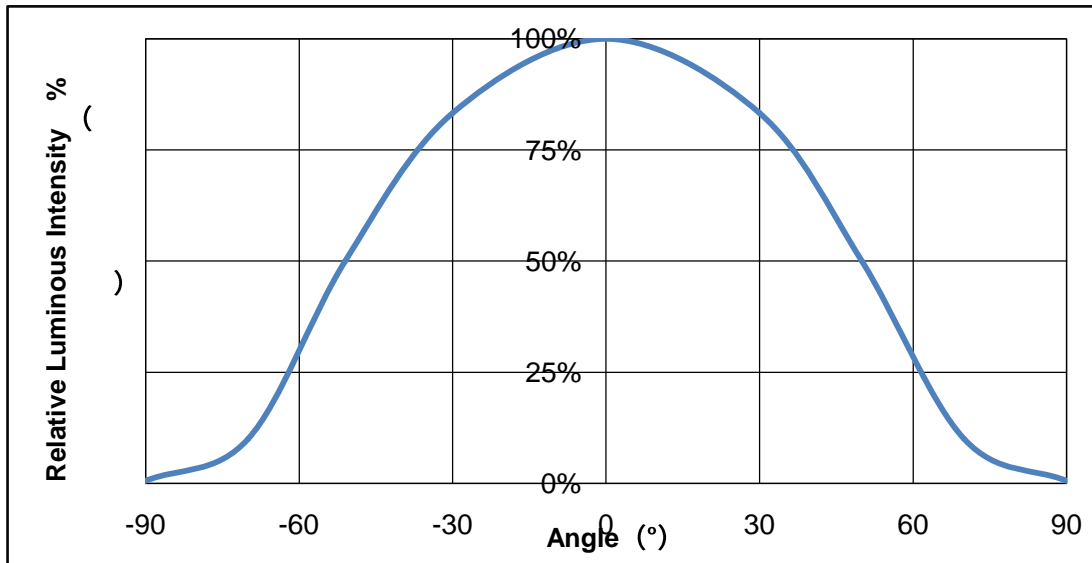

Fig 1-10 Radiation diagram 辐射特性曲线

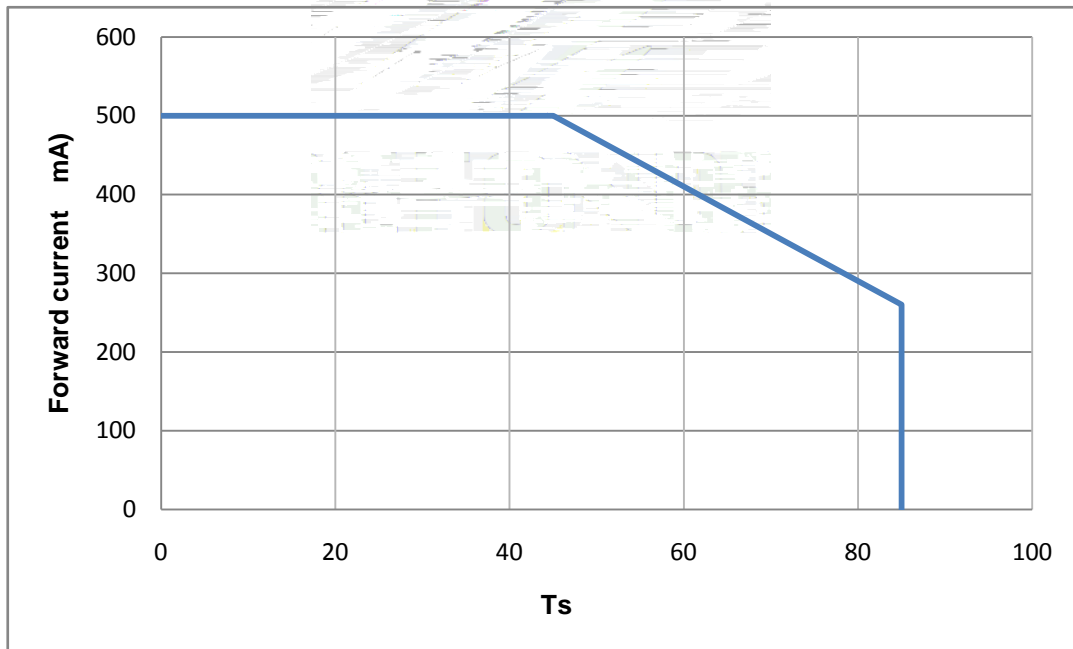
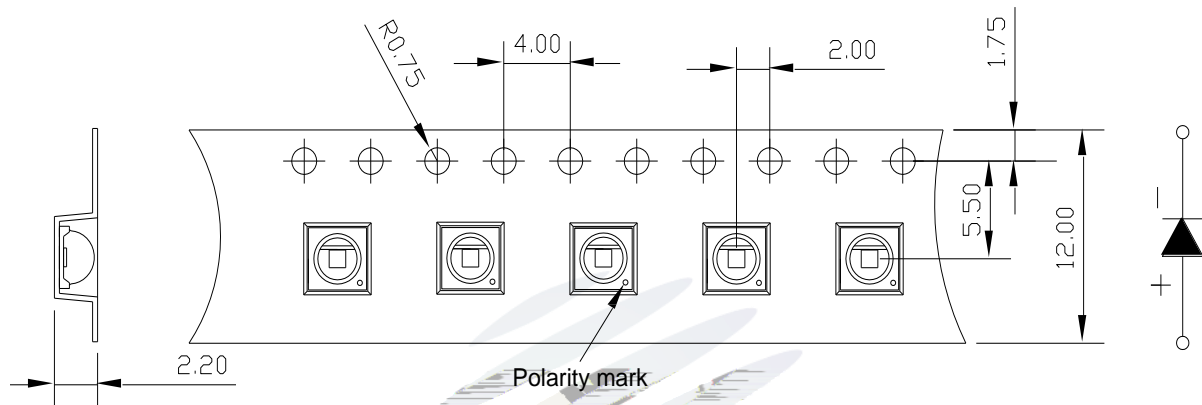

Fig 1-11 Ts Temperature Vs Forward Current 管脚温度与正向电流特性曲线

## 2. Packaging 产品包装

### 2.1 Packaging Specification 包装规格

Package:3000pcs/reel.包装每卷 3000pcs。



#### 2.1.1 Carrier Tape Dimension 载带尺寸

Fig.2-1 Carrier Tape Dimension 载带尺寸

#### 2.1.2 Reel Dimension 卷盘尺寸

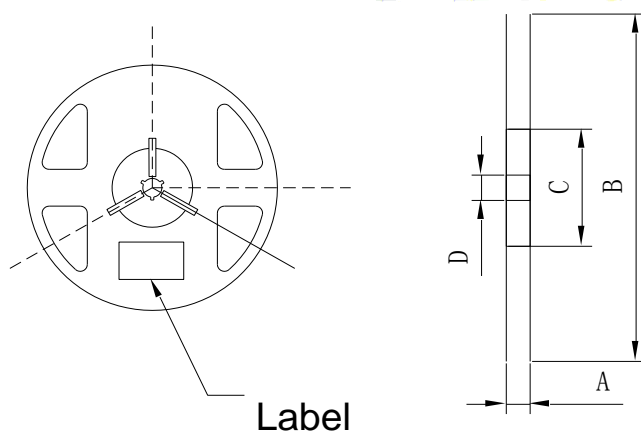

Table 2-1 Dimension 尺寸

A	12.7±0.3mm
B	330.2±2mm
C	79.5±1mm
D	14.3±0.2mm

Fig.2-2 Reel Dimension 卷盘

Notes 备注:

The tolerances unless mentioned  $\pm 0.1\text{mm}$ . Unit : mm 注：未注公差为 $\pm 0.1$ 毫米，尺寸单位：毫米。

### 2.1.3 Label Form Specification 标签规格

Table 2-2 Label Form Specification 标签规格

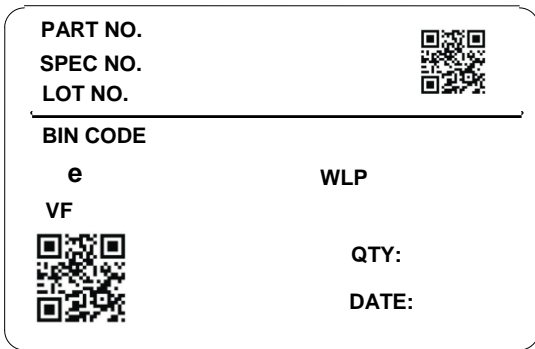

PART NO	Part Number 品名
SPEC NO	Spec Number 规格
LOT NO	Lot Number 批次号
BIN CODE	Bin Code 色区
	Total radiant flu 辐射功率
WLP	Peak Wavelength 峰值波长
VF	Forward Voltage 正向电压
QTY	Packing Quantity 数量
DATE	Made Date 生产日期

Fig 2-3 Label Form Specification 标签规格

### 2.2 Moisture Resistant Packing 防潮包装



Fig.2-4 Moisture Resistant Packing 防潮包装

### 2.3 Cardboard Box 包装纸箱

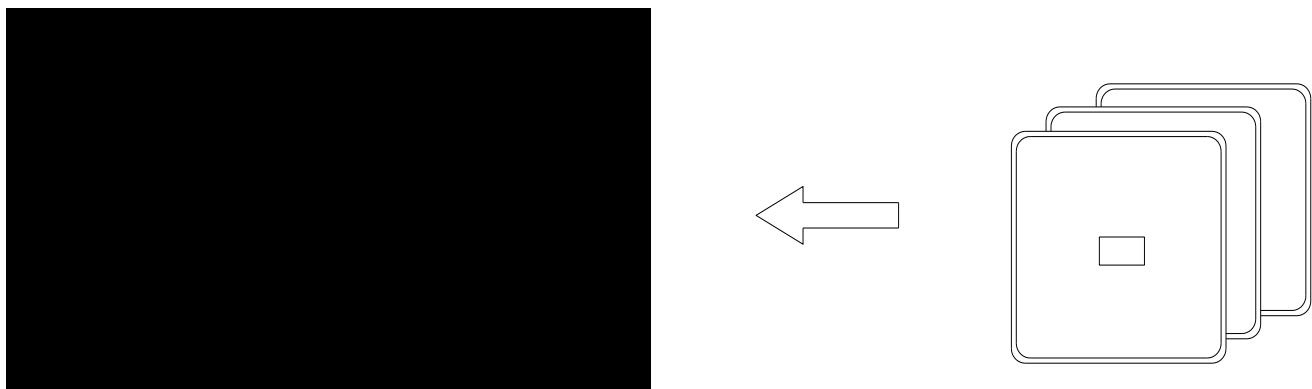
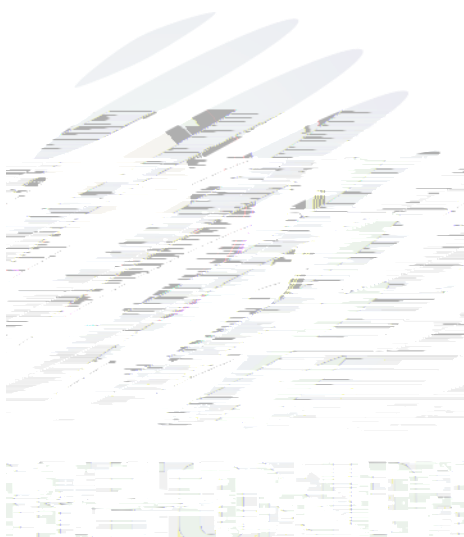

Fig.2-5 Cardboard Box 包装纸箱



## 2.5 Criteria For Judging Damage 失效判定标准

Table Criteria For Judging Damage 失效判定标准

Test Items 项目	Symbol 符号	Test Condition 测试条件	Criteria For Judgement 判定标准	
			Min. 最小	Max. 最大
Forward Voltage 正向电压	$V_F$	$I_F=350\text{mA}$	-	$U.S.L^*)\times 1.1$
Reverse Current 反向电流	$I_R$	$V_R = 5V$	-	$U.S.L^*)\times 2.0$
Total radiant flux 辐射功率	$e$	$I_F=350\text{mA}$	$L.S.L^*)\times 0.7$	-

Notes 备注:

1.U.S.L: Upper standard level 规格上限 L.S.L: Lower standard level 规格下限

### 3. SMT Reflow Soldering Instructions SMT 回流焊说明

#### 3.1 SMT Reflow Soldering Instructions SMT 回流焊说明

Fig.3-1 SMT Reflow Soldering Instructions SMT 回流焊说明

Table 3-1 Parameter 参数

Average temperature rise speed 平均升温速度 (T <sub>max</sub> 至T <sub>P</sub> )	最高3 °C/秒 Max 3 °C/ s
Preheating: minimum temperature 预热：最低温度 (T <sub>min</sub> )	150 °C
Preheating: Max temperature 预热：最高温度 (T <sub>max</sub> )	200 °C
Preheating: Time 预热：时间 (T <sub>min</sub> 至T <sub>max</sub> )	60 - 120秒

Notes 备注:

(1)Reflow soldering should not be done more than two times. In the case of more than 24 hours passed soldering after first, LEDs will be damaged. 回流焊次数不可以超过两次，两次回流焊的时间间隔如果超过24小时，LED可能由于吸湿而损坏。

(2)When soldering , do not put stress on the LEDs during heating.当焊接时，不要在材料受热时用力压胶体表面。

3.1.1



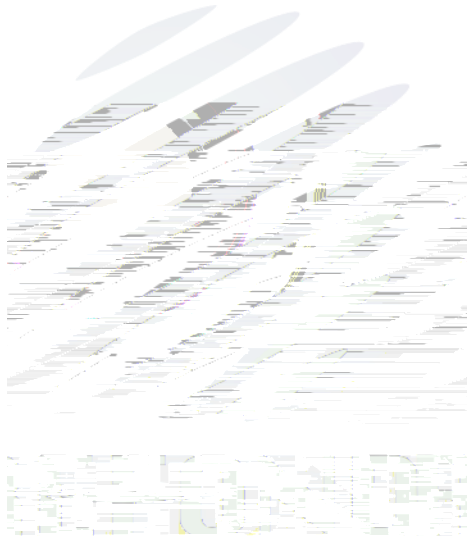



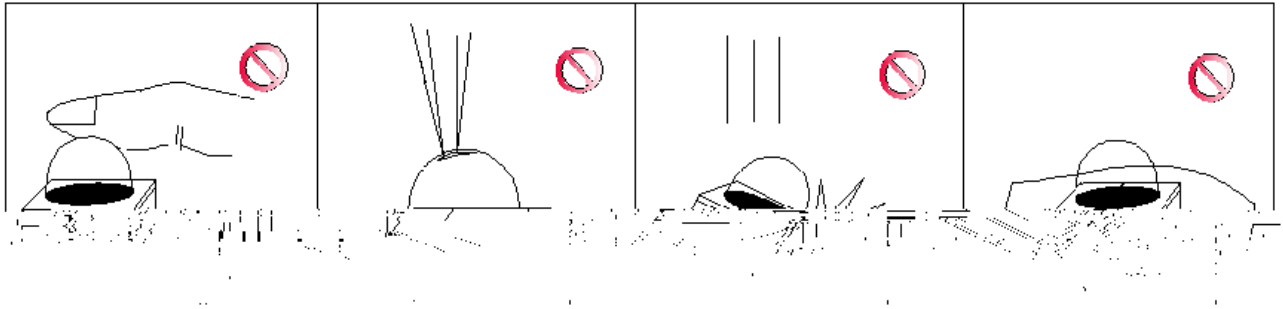

Fig 4-1

(5) In designing a circuit, the current through each LED can not be exceed the absolute maximum rating specified for each LED. In the meanwhile, resistors for protection should be applied, otherwise slight voltage shift will cause big current change, burn out may happen. The driving circuit must be designed to allow forward voltage only when it is ON or OFF. If the reverse voltage is applied to LED, migration can be generated resulting in LED damage. 设计电路时，通过 LED 的电流不能超过规定的最大值。同时，还需使用保护电阻，否则，微小的电压变化将会引起较大电流变化，可能导致产品损毁。电路设计必须保证只有在开启或者关闭的时候出现正向电压的变化，不要施加反压，否则会损坏 LED。

(6) Thermal Design is paramount importance because heat generation may result in the Characteristics decline, such as brightness decreased, Color change and so on. Please consider the heat generation of the LEDs when making the system design. LED 亮度与发光效率均随温度的提高而降低，温度越高，LED 发光效率，影响发光颜色，所以在设计时应充分考虑散热问题。

(7) Compared to standard encapsulants, silicone is generally softer, and the surface is more likely to attract dust, requiring special care during processing. In cases where a minimal level of dirt and dust particles cannot be guaranteed, a suitable cleaning solution must be applied to the surface after the soldering of components. Refond suggests using isopropyl alcohol for cleaning. In case other solvents are used, it must be assured that these solvents do not dissolve the package or resin. Ultrasonic cleaning is not recommended. Ultrasonic cleaning may cause damage to the LED. 与其他封装胶相比，硅胶通常较软，表面易吸附脏物，应用时应特别注意，当对产品洁净度要求较高时，回流焊以后需要采用恰当的清洗方式，我们推荐用异丙醇作清洗剂，如需要用到其他清洗剂，必须保证不会破坏封装体，超声清洗可能会对 LED 带来损害，不推荐这种清洗方式。

Table 4-1 Storage 儲存

Conditions 种类		Temperature 温度	Humidity 湿度	Time 时间
Storage	Before Opening Aluminum Bag 拆包前	$\leq 30^{\circ}\text{C}$	$\leq 75\%$	Within 1 Year From Date 一年内
	After Opening Aluminum Bag 拆包后	$\leq 30^{\circ}\text{C}$	$\leq 60\%$	24hours 24小时
Baking 烘烤		$60 \pm 5^{\circ}\text{C}$	-	$\geq 24\text{hours}$ 大于24小时

(8) If the moisture absorbent material (silica gel) has faded away or the LEDs have exceeded the storage time, baking treatment should be performed after unpacking and based on the following condition ( $60 \pm 5$ )  $^{\circ}\text{C}$  for above 24 hours. 如果干燥剂失效或LEDs超过储存时间，需拆包后进行烘烤，烘烤条件： $60 \pm 5^{\circ}\text{C}$ ，大于24小时。

If the package is flatulence or damaged, please notify the sales staff to assist. 如果包装胀气或者破损，请通知销售人员协助处理。

(9) Similar to most Solid state devices; LEDs are sensitive to Electro-Static Discharge (ESD) and Electrical Over Stress (EOS). 像其他的半导体电子器件一样，LED对静电过流击穿非常敏感，需要做好防护。

(10) Other points for attention, please refer to our relevant information.

其它注意事项请参照瑞丰相关资料。





Declare 申明

This specification is written both in English and in Chinese and the latter is formal.

产品规格书以中英文方式书写，若有冲突以中文版本为准。