

SPECIFICATION

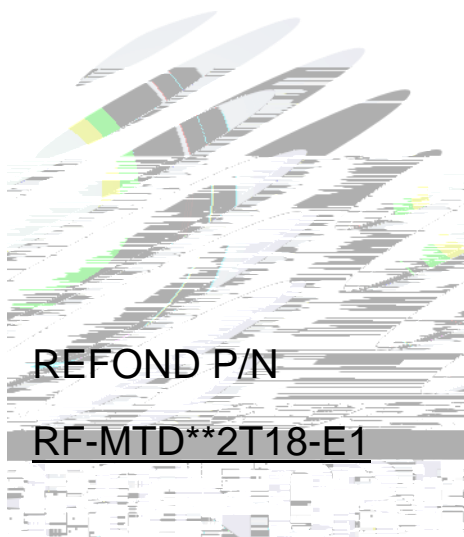

REFOND P/N

RF-MTD**2T18-E1

Mass Product

Contents

- 1. LED Module Description
- 2.LED Module Specification
 - 2.1 Optical-electrical Characteristics(Absolute Maximum Ratings At $T_s=25$) .4
 - 2.2 LED Module Schematic And Interface Definition 6
 - 2.3 LED Module rule of naming : 6
- 3. Product Specification
 - 3.1 Outline Dimension 7
- 4. LED Module Reliability Test
- 5. LED Module Materials Performance Test And Method At $T_a=25$
- 6.Packing Criterion
 - 6.1 Package Diagram / 10
 - 6.2 Blister box Dimensions/ 10
 - 6.3 Carton Dimensions/ 10
 - 6.4 Carton silk printing/ 10
 - 6.5 Label Form Specification/ 11
- 7. Handling Precautions

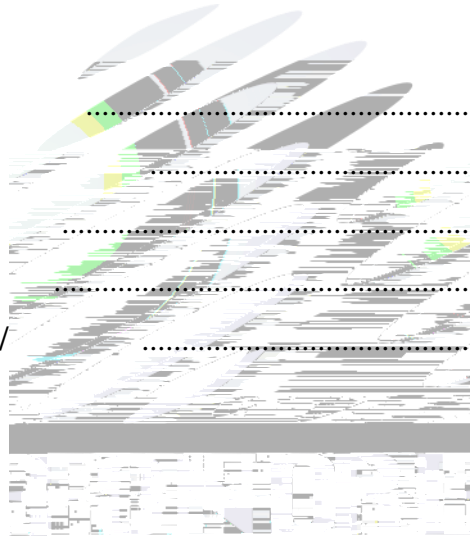

1. LED Module Description

LED Module designed according to the market mainstream of lamps and lanterns, easy to match, assembly is convenient;

LED Module with high reliability and high safety;

LED Module use 2835 LED Package, high lighting efficiency, low heat, without Mercury, belong to the environmental protection cold light source;

LED Module electrical parameter design in line with the market mainstream LED power supply,

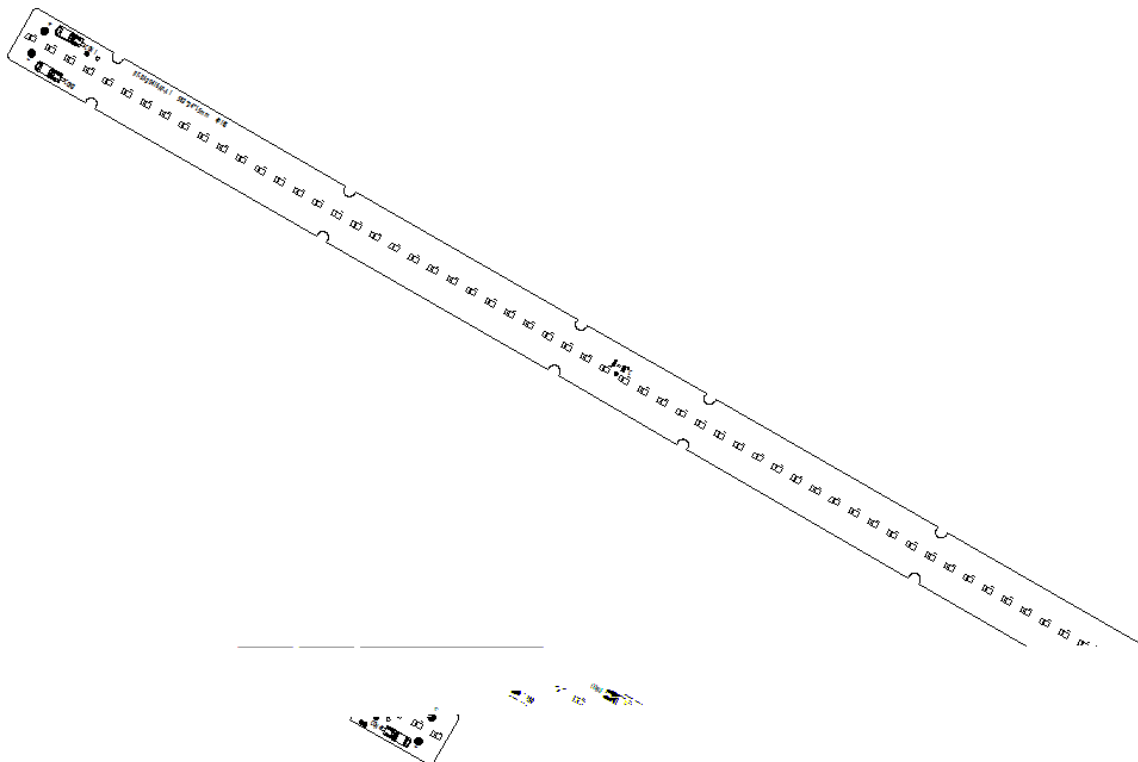
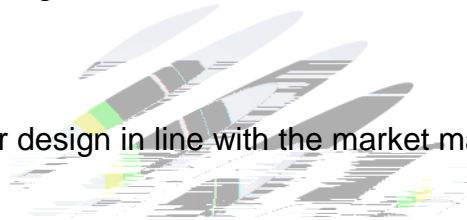

2.LED Module Specification

2.1 Optical-electrical Characteristics(Absolute Maximum Ratings At Ts=25)

Tab.2-1 Optical-electrical Characteristics

Refond PN	Module Characteristics						
	Current mA	Voltage(V)		Power(W)		Module LM	
	Typ	Min	Max	Min	Max	Min	Max
RF-MTD302T18-E1 2870-3220K	360	41.6	52.8	14.976	19.1	2230	2708
RF-MTD352T18-E1 3220-3700K	360	41.6	52.8	14.976	19.1	2346	2850
RF-MTD402T18-E1 3700-4275K	360	41.6	52.8	14.976	19.1	2470	
RF-MTD502T18-E1 4740-5250K	360	41.6	52.8	14.976	19.1	2470	3000
(I mA)Test condition	Color Rendering Index				Min	Max	Typ
360					80	84	83
					4.2		

Absolute Maximum Ratings at Ts=25°C

Parameter	Symbol	Rating	Units
Forward Current	I _F	360	mA
Peak Forward Current	I _{FP}	650	mA
Reverse Voltage	V _R	5	V
Electrostatic Discharge	E _{SD}	2000	V
Operating Temperature	T _{OPR}	-40 ~ +85	
Storage Temperature	T _{STG}	-40 ~ +100	
unction temperature	T _J	115	

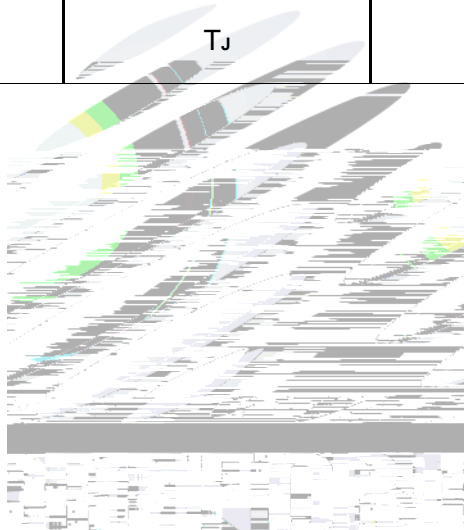

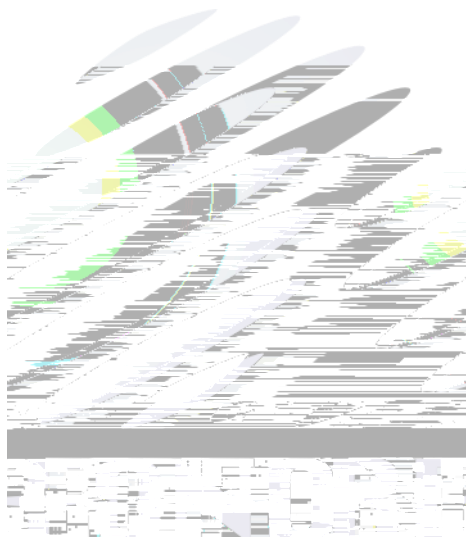

3. Product Specification

3.1 Outline Dimension

	Dimension	Specification	Tolerance
L	Module Length	582	±0.3
W	Module Width	24	±0.3
H1	PCB Thickness PCB	1.5	±0.16
H2	Height of Module	6	±0.3

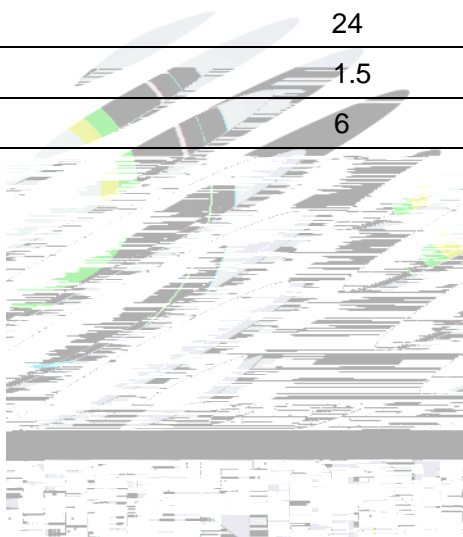

Test Item/	Test Conditions/	Test Time/	Number Of Test/	Judgement Criterions/
Operating Life At Room Temperature/	$T_A=25$ $I_F=360\text{mA}$ $T_J<115$	500Hrs	0/6	1. $6-\ast$ & $V_f<110\%$, $CIE\ x/\ y<0.015$ 2.No catastrophic failure
Operating Life At High Temperature/	$T_A=60$ $I_F=360\text{mA}$ $T_J<115$	500Hrs	0/6	
Operating Life At High Temperature And Humidity/	60 $R_H=90\%$ $I_F=360\text{mA}$ $T_J<115$	500Hrs	0/6	
Thermal Shock/	-40 15min +* 85 15min	100 cycle	0/6	No Dead LED

Notes

voltage distribution, heat dissipation and others.

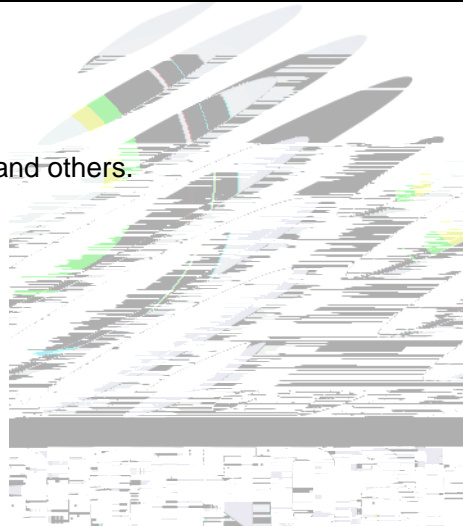

5. LED Module Materials Performance Test And Method At $T_a=25$

Tab 5-1 Light Bar Materials Performance Test And Method Ta=25

Test Item	Test Conditions	Test Methods
LED Optical-electrical Characteristics LED	Compliance With Specifications/	Integrating Sphere/
Connector Pull Force/	1	Notes/
LED Push & Pull Force LED	-	
LED Welding Standards LED	Offset Specifications/	
	X Shift / X * (+/ 5 Y Shift/ Y * (+/ 5 Angle/ - 5	

Notes

Fig 5-1 Push & Pull Test Equipment

Fig 7-2 Push & Pull Test Method

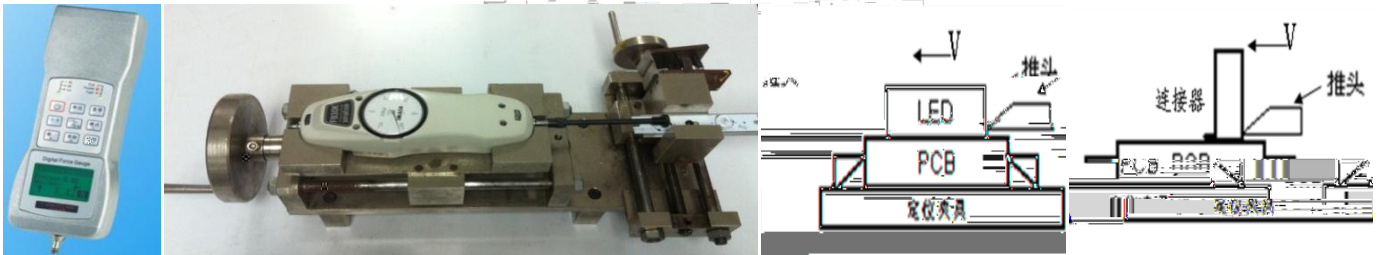

6.Packing Criterion

6.1 Package Diagram /

Fig 8-1 Package Diagram /

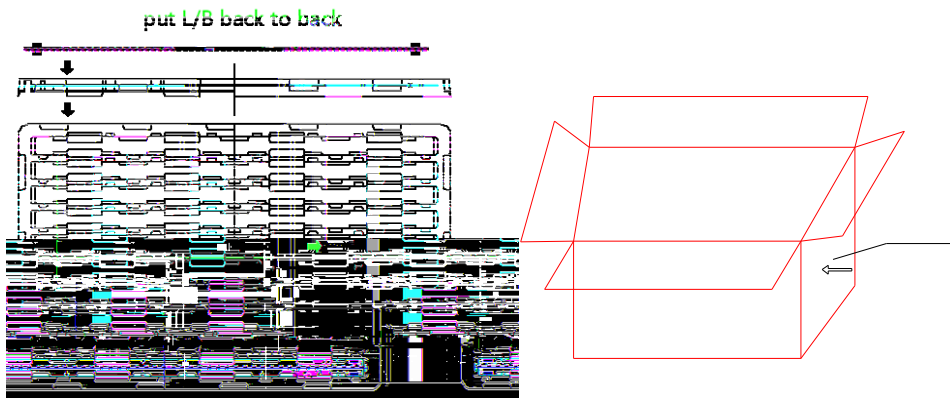

6.2 Blister box Dimensions/

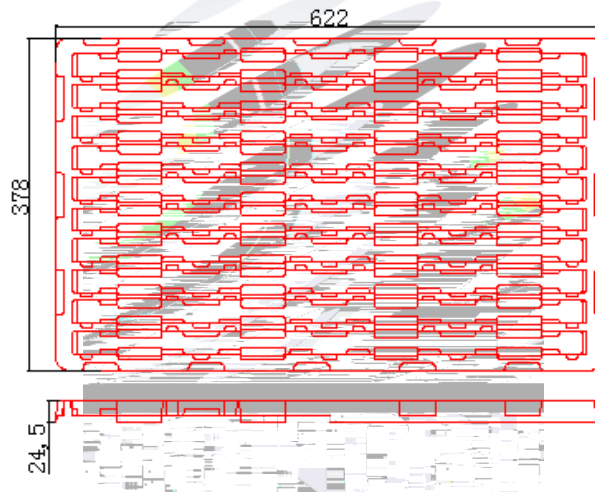

6.3 Carton Dimensions/

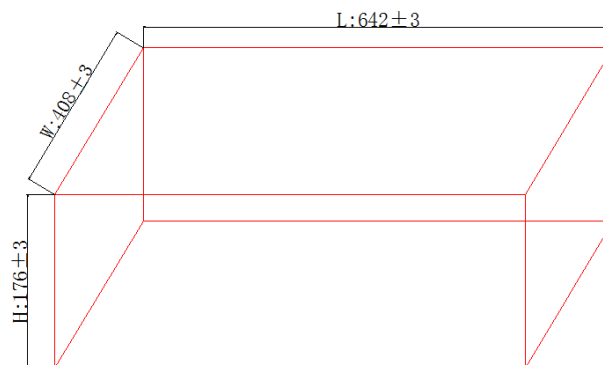

6.4 Carton silk printing/

REFOND LOGO

Pay attention to identify

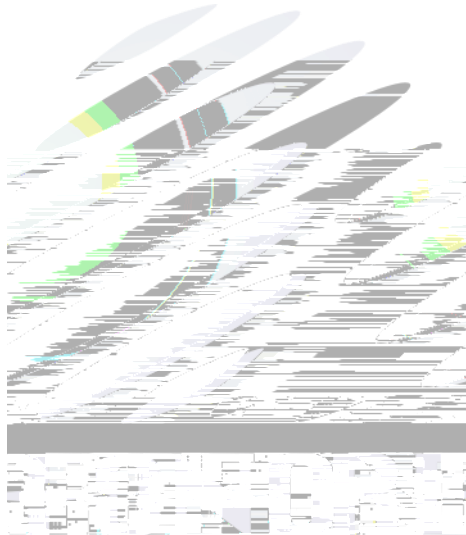

(1) LED operating environment and sulfur element composition cannot be over 100PPM in the LED mating usage material. This is provided for informational purposes only and is not a warranty or endorsement.LED

(2) In order to prevent external material from getting into the inside of LED, which may cause the malfunction of LED, the single content of Bromine element is required to be less than 900PPM,the single content of Chlorine element is required to be less than 900PPM,the total content of Bromine element and Chlorine element in the external materials of the application products is required to be less than 1500PPM. This is provided for informational purposes only and is not a warranty or endorsement.

(3) VOCs (Volatile organic compounds) emitted from materials used in the construction of fixtures can penetrate silicone encapsulants of LEDs and discolor when exposed to heat and photonic energy. The result can be a significant loss of light output from the fixture. Knowledge of the properties of the materials selected to be used in the construction of fixtures can help prevent these issues. Refond advises against the use of any chemicals or materials that have been found or are suspected to have an adverse affect on device performance or reliability. To verify compatibility, Refond recommends that all chemicals and materials be tested in the specific application and environment for which they are intended to be used. Attaching LEDs, do not use adhesives that outgas organic vapor.

(4) Handle the component along the side surface by using forceps or appropriate tools; do not directly touch or Handle the silicone lens surface, it may damage the internal circuitry.

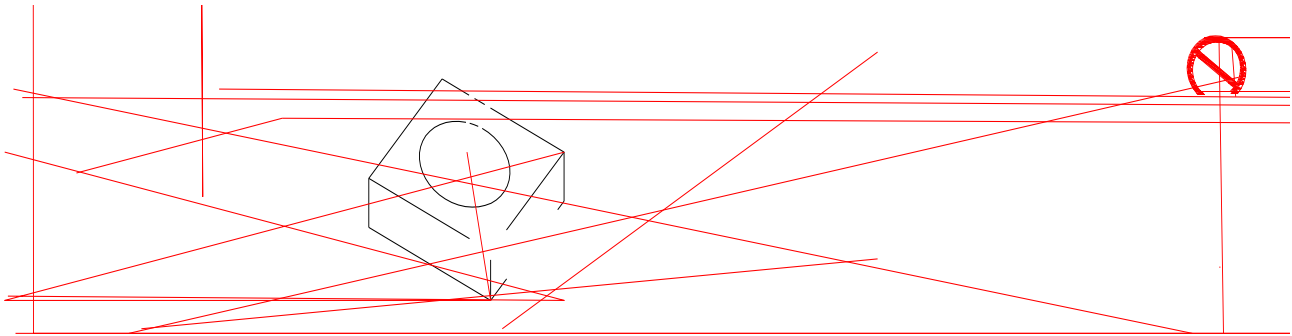

(5) In designing a circuit, the current through each LED can not be exceed the absolute maximum rating specified for each LED. In the mean while, resistors for protection should be applied, otherwise slight voltage shift will cause big current change, burn out may happen. The driving circuit must be designed to allow forward voltage only when it is ON or OFF. If the reverse voltage is applied to LED, migration can be generated resulting in LED damage.

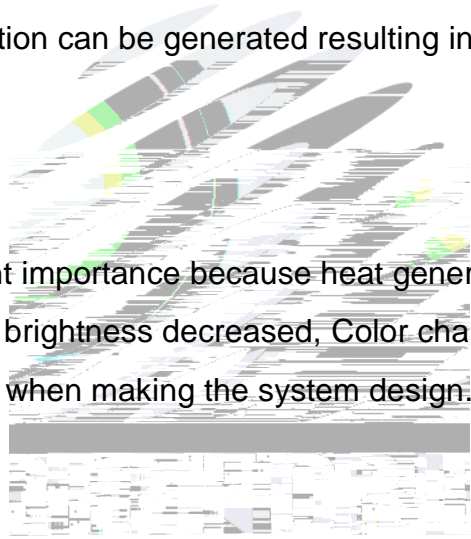

(6) Thermal Design is paramount importance because heat generation may result in the Characteristics decline, such as brightness decreased, Color change and so on. Please consider the heat generation of the LEDs when making the system design. LED

(7) Compared to standard encapsulants, silicone is generally softer, and the surface is more likely to attract dust , requiring special care during processing. In cases where a minimal level of dirt and dust particles cannot be guaranteed, a suitable cleaning solution must be applied to the surface after the soldering of components. Refond suggests using isopropyl alcohol for cleaning. In case other solvents are used, it must be assured that these solvents do not dissolve the package or resin. Ultrasonic cleaning is not recommended. Ultrasonic cleaning may cause damage to the LED.

(8) Similar to most Solid state devices; LEDs are sensitive to Electro-Static Discharge (ESD) and Electrical Over Stress (EOS).

9>.NO warping or twisting the Light Bar more than 10°. Forbidding holding the LED part or connector part when handling.

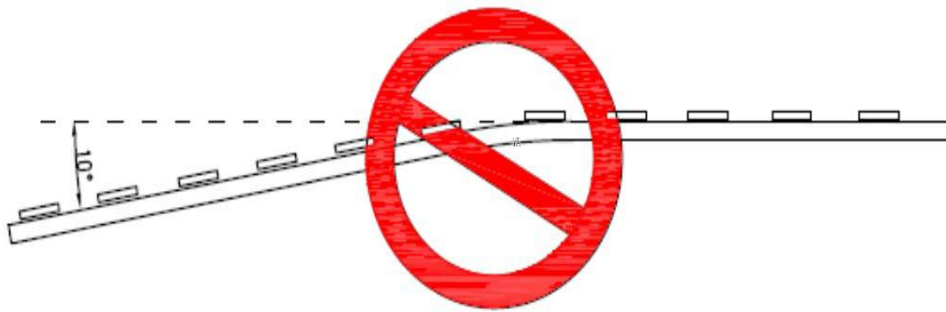

(10) Other points for attention, please refer to our relevant information.

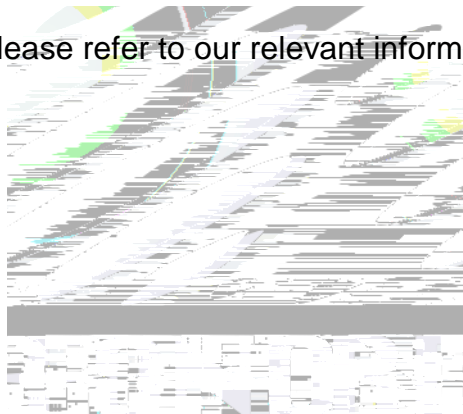

Version History/

Date	Revisor	Version	Verifier	Remarks
2019-11-21		E/1		The first edition

--	--	--	--	--

