

# SPECIFICATION

LT P/N

LT264WH-A-Q

R&D

Mass Product

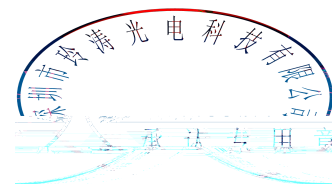

## Contents

1. Description .....	3
1.1 General Description	

## 1. Description

### 1.1 General Description



The White LED, which was fabricated by using a blue chip and the phosphor.

Product Package: 2.6mmX0.6mmX0.4mm.

LED, , : 2.6mmX0.6mmX0.4mm

### 1.2 Features

PLCC Package. PLCC

Wide viewing angle.

Suitable for all SMT assembly and solder process.

SMT

Available on tape and reel.

Moisture sensitivity level: Level 3.

Level 3

RoHS compliant. RoHS

### 1.3 Application

LCD Back Light. LCD

Mobile Phones.

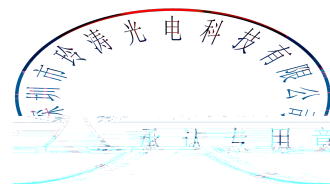

## 1.4 Package Dimension

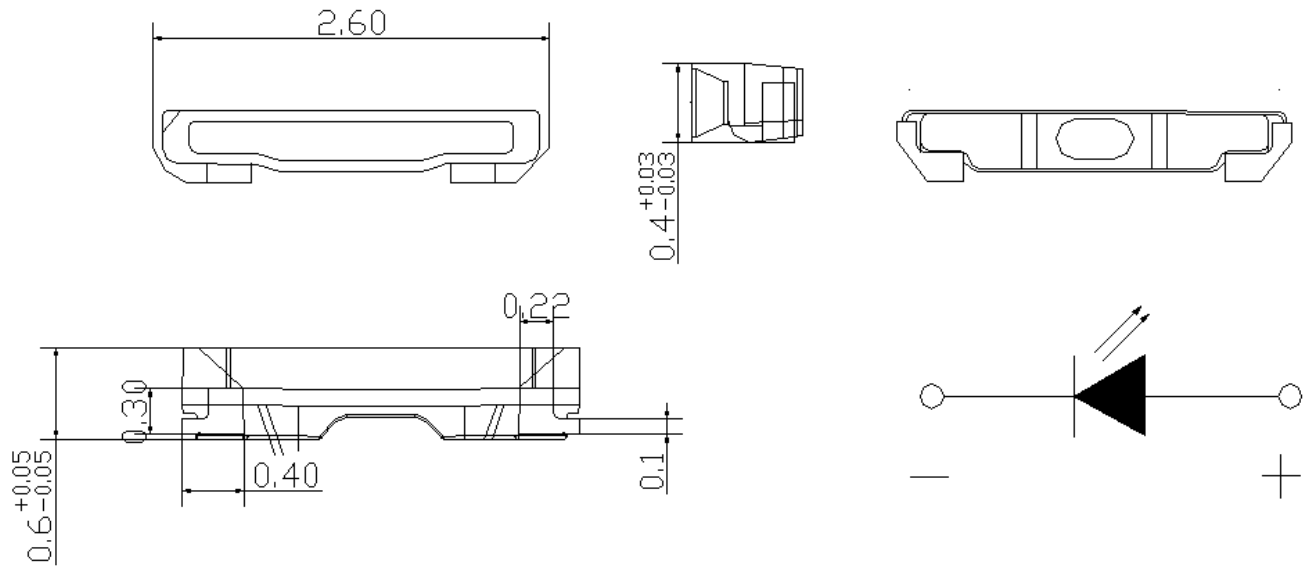

### Notes

1. All dimensions units are millimeters.
2. All dimensions tolerances are  $\pm 0.1$ mm unless otherwise noted. 0.1

## 1.5 Product Parameters

Table 1-1 Electrical / Optical Characteristics at  $T_s=25^\circ\text{C}$

Item	Symbol	Test Condition	Value			Unit
			Min.	Typ.	Max.	
Forward Voltage	$V_F$	$I_F=20\text{mA}$	---	2.8	---	V
Reverse Current	$I_R$	$V_R=5\text{V}$	---	---	1	$\mu\text{A}$
Luminous Intensity	$I_v$	$I_F=20\text{mA}$	---	2850	---	mcd
Viewing Angle		$I_F=20\text{mA}$	---	120	---	deg

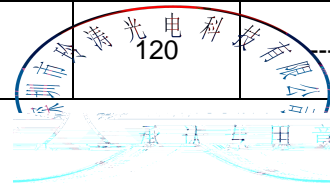
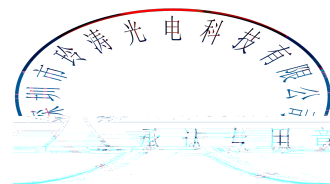

Table 1-2 Absolute Maximum Ratings at Ts=25°C

Notes

1. 1/10 Duty cycle, 0.1ms pulse width.      0.1ms,      1/10.





optoelectronics

玲涛光电

LTTG-201907310027GP

## 1.6 Bin Range Of Forward Voltage and Luminous Intensity (IF=20mA)

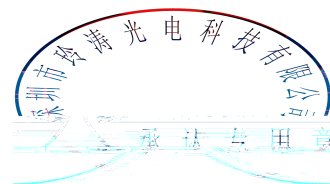

Fig. 1-5 The C.I.E. 1931 Chromaticity Diagram: ( L&T&H )

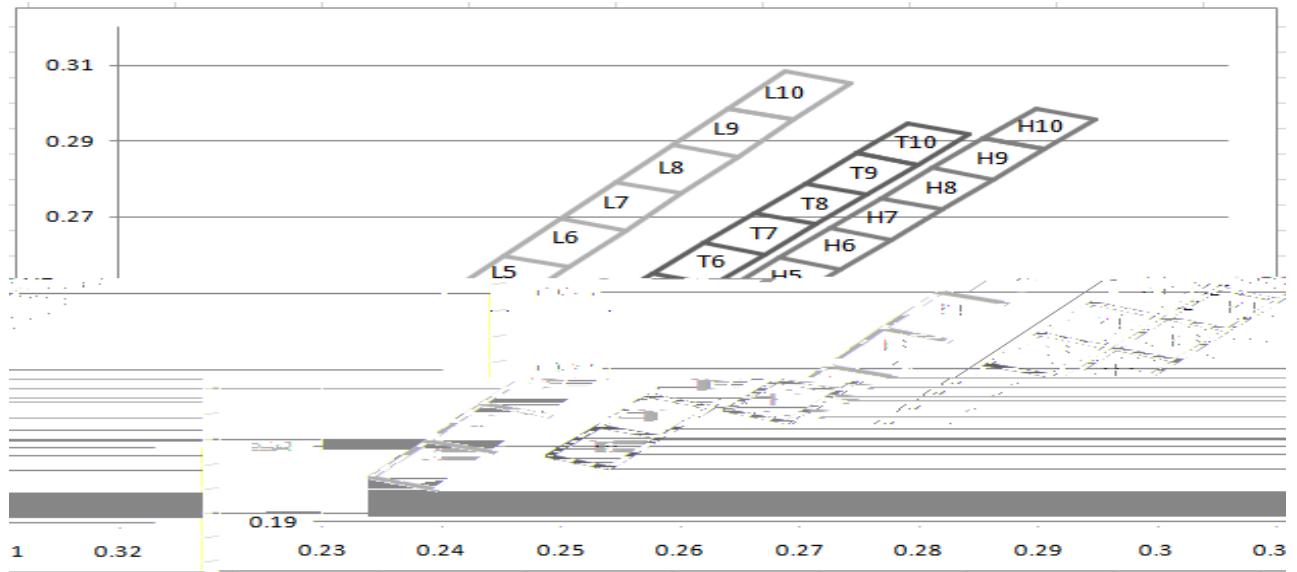

Table 1-6 Bin Range of Chromaticity Coordinates Block ( IF=20mA ; Ta=25 )

L0	0.2341	0.2016	T0	0.2489	0.2072	H1	0.2638	0.2192
	0.2388	0.2113		0.2532	0.2151		0.2681	0.2272
	0.2443	0.2083		0.2583	0.2121		0.2732	0.2242
	0.2396	0.1986		0.2540	0.2042		0.2689	0.2162
L1	0.2388	0.2113	T1	0.2532	0.2152	H2	0.2681	0.2272
	0.2435	0.2210		0.2575	0.2231		0.2724	0.2352
	0.2490	0.2180		0.2626	0.2201		0.2775	0.2322
	0.2443	0.2083		0.2583	0.2122		0.2732	0.2242
L2	0.2435	0.2210	T2	0.2575	0.2232	H3	0.2724	0.2352
	0.2482	0.2307		0.2618	0.2311		0.2767	0.2432
	0.2537	0.2277		0.2669	0.2281		0.2818	0.2402
	0.2490	0.2180		0.2626	0.2202		0.2775	0.2322
L3	0.2482	0.2307	T3	0.2618	0.2312	H4	0.2767	0.2432
	0.2529	0.2404		0.2661	0.2391		0.2810	0.2511
	0.2584	0.2374		0.2712	0.2361		0.2861	0.2481
	0.2537	0.2277		0.2669	0.2282		0.2818	0.2402
L4	0.2529	0.2404	T4	0.2661	0.2392	H5	0.2810	0.2511
	0.2576	0.2501		0.2704	0.2471		0.2853	0.2591
	0.2631	0.2471		0.2755	0.2441		0.2904	0.2561
	0.2584	0.2374		0.2712	0.2362		0.2861	0.2481

L5	0.2576	0.2501	T5	0.2704	0.2471	H6	0.2853	0.2591
	0.2623	0.2598		0.2747	0.2551		0.2896	0.2670
	0.2678	0.2568		0.2798	0.2521		0.2947	0.2640
	0.2631	0.2471		0.2755	0.2441		0.2904	0.2561
L6	0.2623	0.2598	T6	0.2747	0.2551	H7	0.2896	0.2670
	0.2670	0.2695		0.2790	0.2630		0.2939	0.2750
	0.2725	0.2665		0.2841	0.2600		0.2990	0.2720
	0.2678	0.2568		0.2798	0.2521		0.2947	0.2640
L7	0.2670	0.2695	T7	0.2790	0.2630	H8	0.2939	0.2750
	0.2717	0.2792		0.2833	0.2710		0.2982	0.2829
	0.2772	0.2762		0.2884	0.2680		0.3033	0.2799
	0.2725	0.2665		0.2841	0.2600		0.2990	0.2720
L8	0.2717	0.2792	T8	0.2833	0.2710	H9	0.2982	0.2829
	0.2764	0.2889		0.2876	0.2789		0.3025	0.2908
	0.2819	0.2859		0.2927	0.2759		0.3076	0.2878
	0.2772	0.2762		0.2884	0.2680		0.3033	0.2799
L9	0.2764	0.2889	T9	0.2876	0.2789	H10	0.3025	0.2908
	0.2811	0.2986		0.2919	0.2868		0.3068	0.2987
	0.2866	0.2956		0.2970	0.2838		0.3119	0.2957
	0.2819	0.2859		0.2927	0.2759		0.3076	0.2878
L10	0.2811	0.2986	T10	0.2919	0.2868			
	0.2858	0.3083		0.2962	0.2947			
	0.2913	0.3053		0.3013	0.2917			
	0.2866	0.2956		0.2970	0.2838			

Fig. 1-7 The C.I.E. 1931 Chromaticity Diagram: ( LA&LB ) )

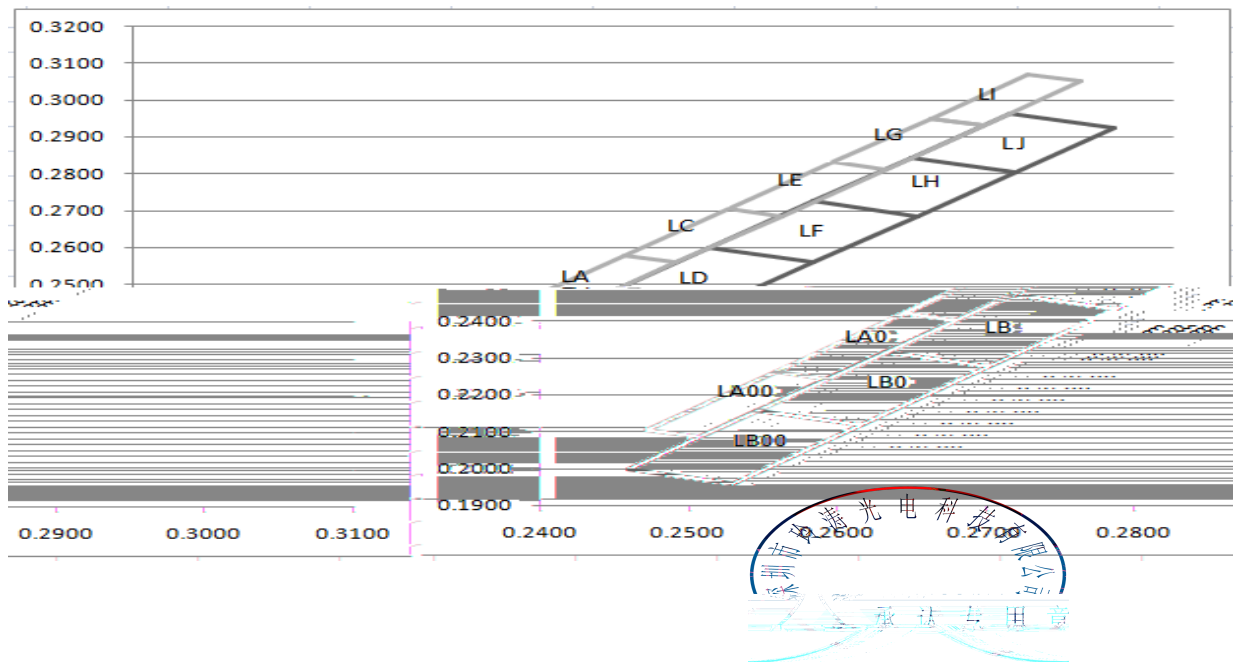





Table 1-8 Bin Range of Chromaticity Coordinates Block (IF=20mA ;Ta=25 )

---

	0.2472	0.2105		0.2558	0.2263		0.2644	0.2421
LA00			LA0			LA		

---

Table 1-10 Bin Range of Chromaticity Coordinates Block (IF=20mA ;Ta=25 )

LR1	0.2386	0.2021	LR2	0.2446	0.2144	LR3	0.2506	0.2268
	0.2446	0.2144		0.2506	0.2268		0.2565	0.2391
	0.2501	0.2114		0.2561	0.2238		0.2620	0.2361
	0.2441	0.1991		0.2501	0.2114		0.2561	0.2238
LR4	0.2565	0.2391	LR5	0.2625	0.2515	LR6	0.2685	0.2638
	0.2625	0.2515		0.2685	0.2638		0.2745	0.2762
	0.2680	0.2485		0.2740	0.2608		0.2800	0.2732
	0.2620	0.2361		0.2680	0.2485		0.2740	0.2608
LR7	0.2745	0.2762	LR8	0.2805	0.2885	LR9	0.2865	0.3009
	0.2805	0.2885		0.2865	0.3009		0.2924	0.3132
	0.2860	0.2855		0.2920	0.2979		0.2979	0.3102
	0.2800	0.2732		0.2860	0.2855		0.2920	0.2979
LR10	0.2924	0.3132	TB0	0.2510	0.2113	TB1	0.2575	0.2232
	0.2984	0.3256		0.2575	0.2232		0.2639	0.2352
	0.3039	0.3226		0.2626	0.2202		0.2690	0.2322
	0.2979	0.3102		0.2562	0.2082		0.2626	0.2202
TB2	0.2639	0.2352	TB3	0.2704	0.2471	TB4	0.2768	0.2591
	0.2704	0.2471		0.2768	0.2591		0.2833	0.2710
	0.2755	0.2441		0.2819	0.2561		0.2884	0.2680
	0.2690	0.2322		0.2755	0.2441		0.2819	0.2561
	0.2833	0.2710		0.2573	0.2073		0.2638	0.2192
TB5	0.2897	0.2829	LH1	0.2638	0.2192	LH2	0.2702	0.2311

Fig. 1-11 The C.I.E. 1931 Chromaticity Diagram: ( LB2&K )

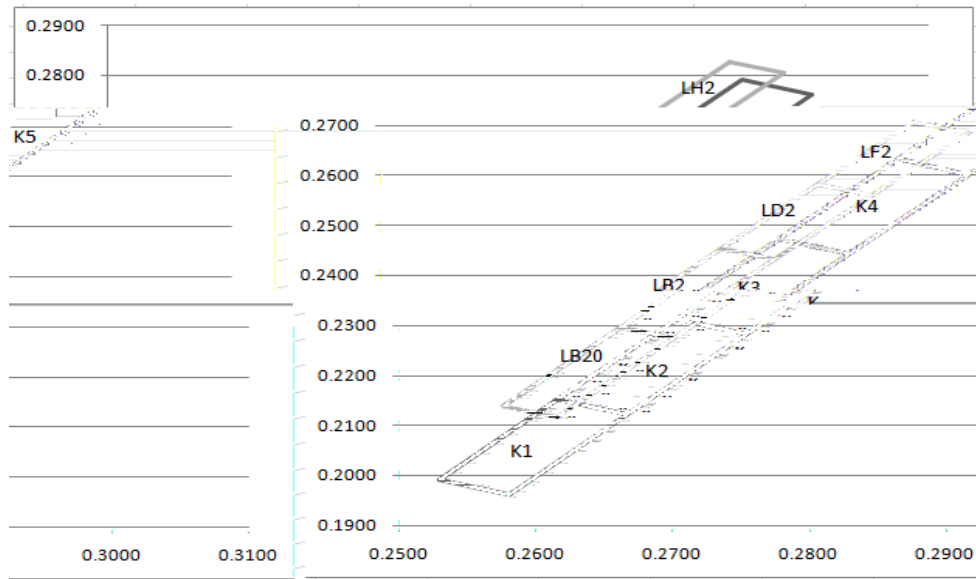

Table 1-12 Bin Range of Chromaticity Coordinates Block ( IF=20mA ; Ta=25 )

LB20	0.2576	0.2139	LB2	0.2662	0.2297	LD2	0.2748	0.2455
	0.2662	0.2297		0.2748	0.2455		0.2819	0.2581
	0.2701	0.2275		0.2787	0.2433		0.2858	0.2559
	0.2615	0.2117		0.2701	0.2275		0.2787	0.2433
LF2	0.2819	0.2581	LH2	0.2889	0.2707	K1	0.2529	0.1992
	0.2889	0.2707		0.2955	0.2826		0.2616	0.2152
	0.2928	0.2685		0.2994	0.2804		0.2667	0.2122
	0.2858	0.2559		0.2928	0.2685		0.2580	0.1962
K2	0.2616	0.2152	K3	0.2703	0.2312	K4	0.2790	0.2472
	0.2703	0.2312		0.2790	0.2472		0.2877	0.2632
	0.2754	0.2282		0.2841	0.2442		0.2928	0.2602
	0.2667	0.2122		0.2754	0.2282		0.2841	0.2442
K5	0.2877	0.2632						
	0.2964	0.2792						
	0.3015	0.2762						
	0.2928	0.2602						

Notes

1 Measurement uncertainty of the color coordinates: 0.003.

2 The new white dustbin refers to the application of small backlight standard.

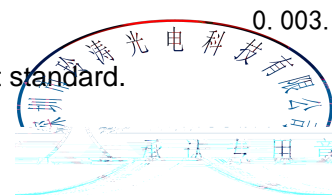

## 1.7 Typical Optical Characteristics Curves

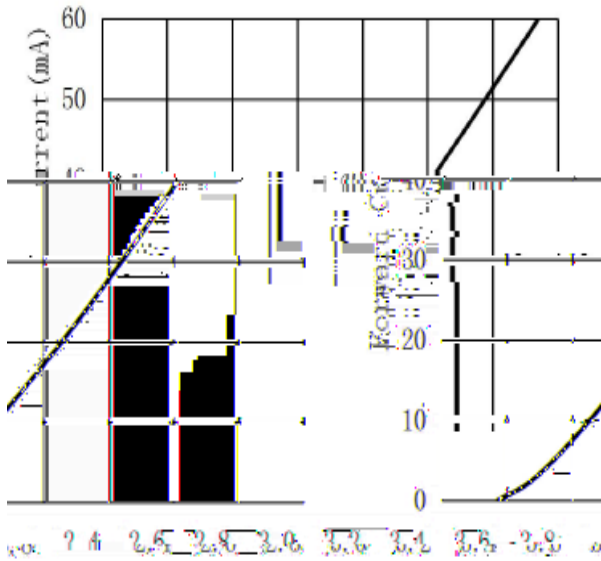

Fig. 1-13 Forward Voltage Vs Forward Current

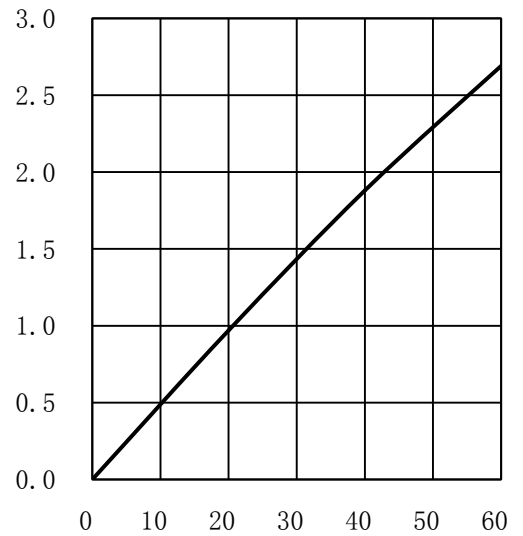

Fig. 1-14 Forward Current Vs Relative Intensity

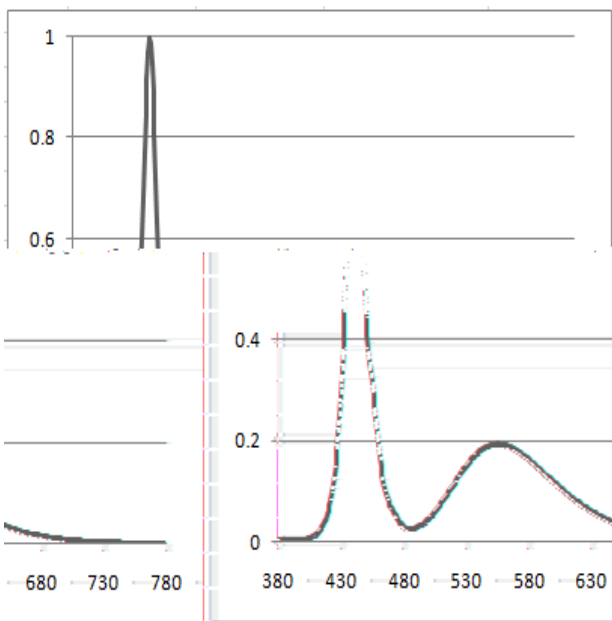

Fig. 1-16 Spectrum Distribution

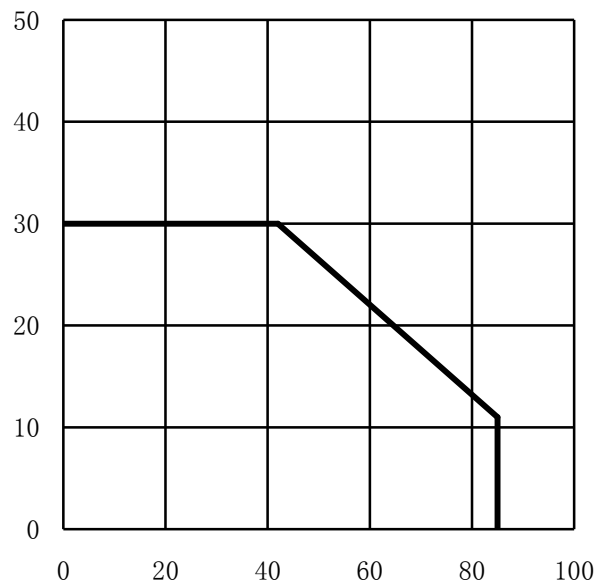
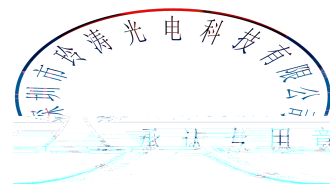

Fig. 1-15 Solder Temperature Vs Forward Current

Tj 105



## 2. Packaging

### 2.1 Packaging Specification

Package:5000pcs/reel.

5000pcs

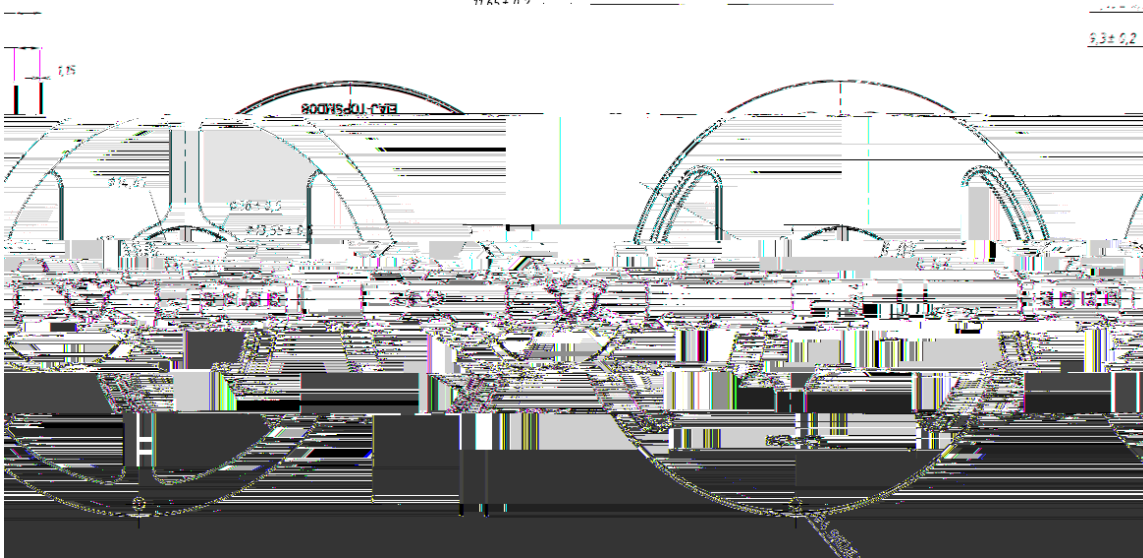

#### 2.1.1 Carrier Tape Dimension

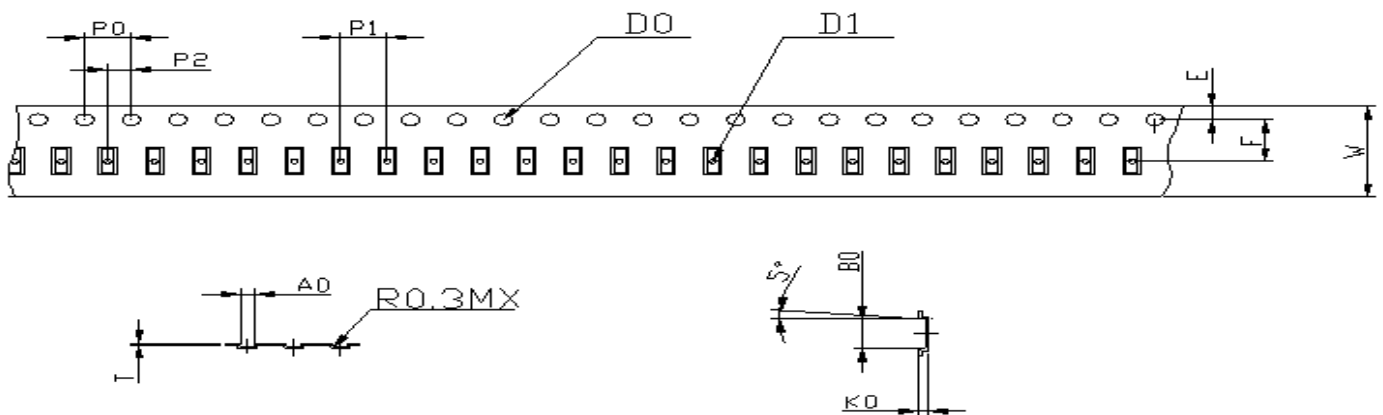

P0	4.00±0.10	P2	2.00±0.05	P1	4.00±0.10	D0	1.60±0.10	D1	0.60±0.10
E	1.75±0.10	F	3.50±0.10	W	8.00±0.20	A0	0.85±0.10	T	0.20±0.10
B0	2.80±0.10	K0	0.55±0.10						

Fig.2-1 Carrier Tape Dimension

#### Notes

The tolerances unless mentioned ±0.2mm. Unit : mm

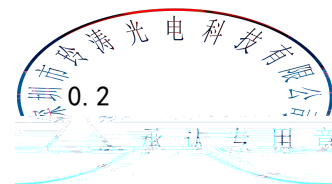

## 2.1.2 Label Form Specification

Table 2-2 Label Map



Table 2-3 Label Form Specification

PART NO.	Part Number
BIN CODE	Bin Code
IV	Luminous intensity
V <sub>F</sub>	Forward Voltage
WL	Wavelength
QTY	Packing Quantity
DATE	Made Date
LOT NO	Lot Number

## 2.2 Moisture Resistant Packing

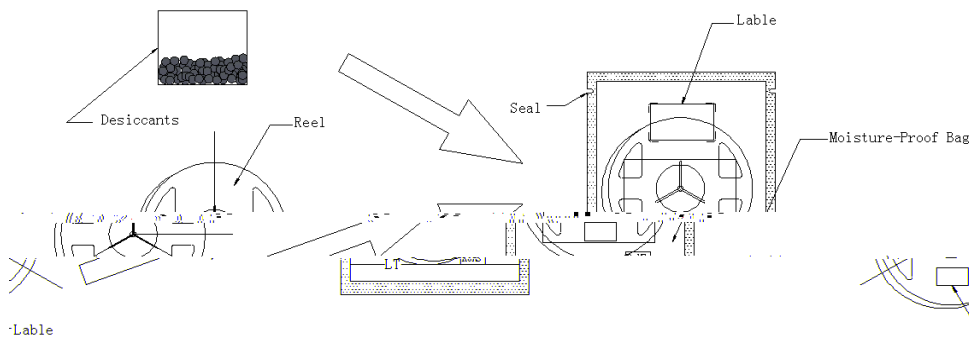

Fig.2-4 Moisture Resistant Packing

## 2.3 Cardboard Box

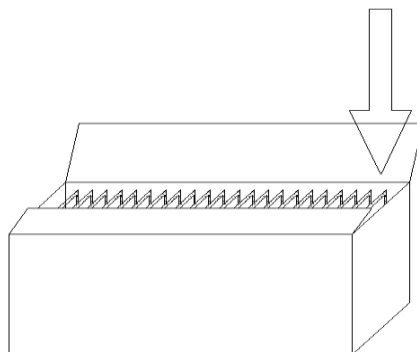
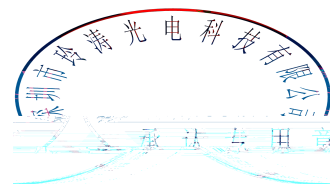

Fig.2-5 Cardboard Box



## 2.4 Reliability Test Items And Conditions

Table 2-6 Reliability Test Items And Conditions

Test Items	Test Condition	Time	Quantity	Ac/Re /
Reflow	Temp:260 max T=10 sec	---	20pcs.	0/1
Thermal Shock	-40 20min 10s 100 20min	100 cycle	20pcs.	0/1
High Temperature Storage	Temp:100	1000hrs.	20pcs.	0/1
Low Temperature Storage	Temp:-40	1000hrs.	20pcs.	0/1
Life Test	Ta=25 If=20mA	1000hrs.	20pcs.	0/1
High Temperature and Humidity storage	60 / 90%RH	1000hrs.	20pcs.	0/1
Temperature Humidity Operation Life	60 / 90%RH If=15mA	500hrs	20pcs.	0/1

## 2.5 Criteria For Judging Damage

Table 2-7 Criteria For Judging Damage

Test Items	Symbol	Test Condition	Criteria For Judgement	
			Min.	Max.
Forward Voltage	V <sub>F</sub>	I <sub>F</sub> =20mA		>U.S.L*)x1.1
Reverse Current	I <sub>R</sub>	V <sub>R</sub> = 5V		>U.S.L*)x2.0

Luminous Flux		$I_F=20\text{mA}$	$<L.S.L^*)\times 0.7$	-
---------------	--	-------------------	-----------------------	---

Notes

- 1.U.S.L: Upper standard level                      L.S.L: Lower standard level
- 2.The above reliability tests is based on the verification of a single/strip LED of LT existing experimental platform,the reliability experiment was taken under good heat dissipation conditions. when customers applies the LED to the series and parallel circuit, should take consideration of all the factors such as the current, voltage distribution, heat dissipation and others. / LED
- 3.The technical information shown in the data sheets is limited to the typical characteristics and circuit examples of the referenced products. It does not constitute the warranting of industrial property nor the granting of any license.

### 3. SMT Reflow Soldering Instructions SMT

#### 3.1 SMT Reflow Soldering Instructions

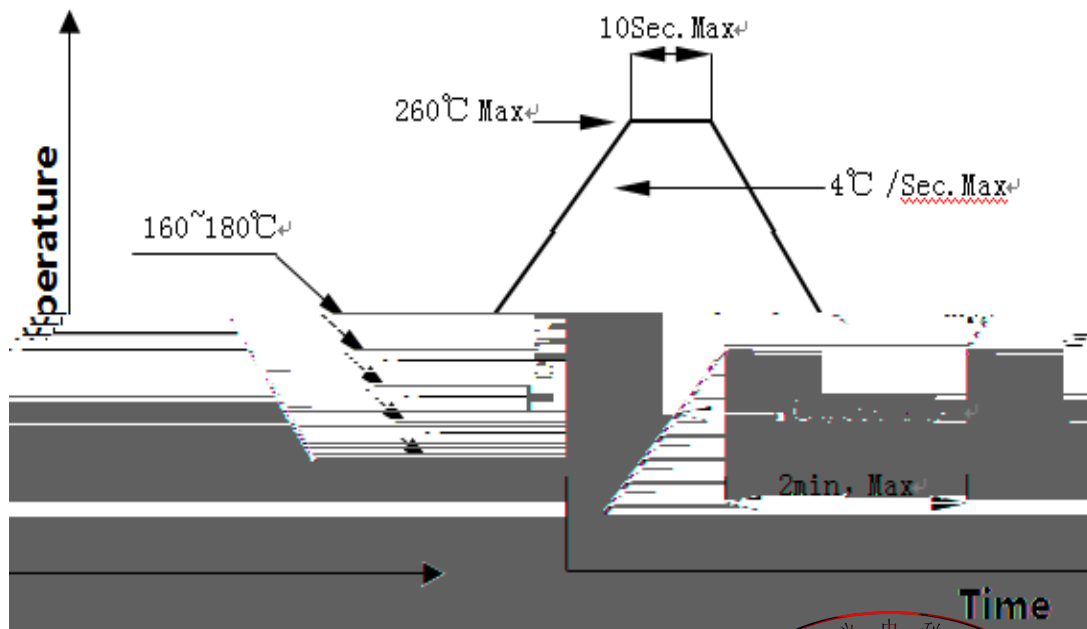

Fig.3-1 SMT Reflow Soldering Map

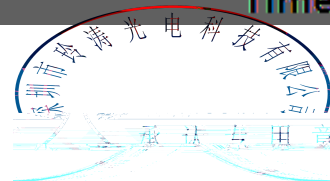



Fig.3-2 SMT Reflow Soldering Instructions SMT

Average temperature rise speed	$T_{smax}$ $T_P$	5 °C/	Max 5 °C/ s
Preheating: minimum temperature	( $T_{smin}$ )	160 °C	
Preheating: Max temperature	( $T_{smax}$ )	260 °C	
Preheating: Time	$T_{smin}$ $T_{smax}$	60 - 120	60s-120s
Time limited to maintain high temperature: the temperature	( $T_L$ )	217 °C	
Time limited to maintain high temperature: The Time	( $t_L$ )	60	Max 60s
Peak /Classification of temperature:	/ ( $T_P$ )	260 °C	
Time limit classification of peak temperature time	$t_p$	10	Max 10s
( $T_P$ ) 5 °C	Hold time within 5 °C with the	30	Max 30s
actual peak temperature (TP)			
Cooling speed		6 °C/	Max 6 °C/ s
25 °C	Needed time from 25 °C to $T_p$	8	Max 8 minutes

Notes

(1)Reflow soldering should not be done more than twice. If more than 24 hours between the two solderings , LED will be damaged.

24 LED

Repairing should not be done after the LEDs have been soldered. When repairing is unavoidable, a double-head soldering iron should be used (as below figure). It should be confirmed in advance whether the characteristics of LEDs will or not be damaged by repairing.

LED

LED

### 3.1.3 Cautions

(1) The encapsulated material of the LEDs is silicone. Therefore the LEDs have a soft surface on the top of package. The pressure to the top surface will be impacted on the reliability of the LEDs. Precautions should be taken to avoid the strong pressure on the encapsulated part. So when use the picking up nozzle, the pressure on the silicone resin should be proper. LED

LED

(2) Components should not be mounted on warped (non coplanar) portion of PCB. After soldering, do not warp the circuit board. LED PCB

(3) Do not apply mechanical force or excess vibration during the cooling process to normal temperature after soldering. Do not rapidly cool device after soldering.

## 4. Handling Precautions

### 4.1 Handling Precautions

(1) LED operating environment and sulfur element composition cannot be over 100PPM in the LED mating usage material. This is provided for informational purposes only and is not a warranty or endorsement. LED LED 100PPM.

(2) In order to prevent external material from getting into the inside of LED, which may cause the malfunction of LED, the single content of Bromine element is required to be less than 900PPM, the single content of Chlorine element is required to be less than 900PPM, the total content of Bromine element and Chlorine element in the external materials of the application

products is required to be less than 1500PPM. This is provided for informational purposes only and is not a warranty or endorsement.

	LED	LED
	900PPM	900PPM
1500PPM.		

(3) VOCs (Volatile organic compounds) emitted from materials used in the construction of fixtures can penetrate silicone encapsulants of LEDs and discolor when exposed to heat and photonic energy. The result can be a significant loss of light output from the fixture. Knowledge of the properties of the materials selected to be used in the construction of fixtures can help prevent these issues. LT advises against the use of any chemicals or materials that have been found or are suspected to have an adverse effect on device performance or reliability. To verify compatibility, LT recommends that all chemicals and materials be tested in the specific application and environment for which they are intended to be used. Attaching LEDs, do not use adhesives that outgas organic vapor.

	LED
LED	

LED

(4) Handle the component along the side surface by using forceps or appropriate tools; do not directly touch or Handle the silicone lens surface, it may damage the internal circuitry.

(5) In designing a circuit, the current through each LED must exceed the absolute maximum rating specified for each LED. In the meanwhile, resistors for protection should be applied, otherwise slight voltage shift will cause big current change, burn out may happen. The driving circuit must be designed to allow forward voltage only when it is ON or OFF. If the reverse voltage is applied to LED, migration can be generated.

the heat generation of the LEDs when making the system design.LED

### LED

(7) Compared to standard encapsulants, silicone is generally softer, and the surface is more likely to attract dust , requiring special care during processing. In cases where a minimal level of dirt and dust particles cannot be guaranteed, a suitable cleaning solution must be applied to the surface after the soldering of components. LT suggests using isopropyl alcohol for cleaning. In case other solvents are used, it must be assured that these solvents do not dissolve the package or resin. Ultrasonic cleaning is not recommended. Ultrasonic cleaning may cause damage to the LED.

### LED

Table 4-1Storage

Conditions	Temperature	Humidity	T
------------	-------------	----------	---

If the package is flatulence or damaged, please notify the sales staff to assist.

(9) Similar to most Solid state devices; LEDs are sensitive to Electro-Static Discharge (ESD) and Electrical Over Stress (EOS).

LED

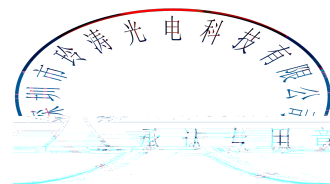

Version History/

Date	Revisor	Version	Verifier	Remarks
2019/5/28		E/0		
2019/9/4		E/1		
2019/9/19		E/2		

