

# SPECIFICATION

REFOND P/N

RF-A2P08-R315-R0

R&D

Mass Production



# Contents

1. Description	
1.1 General Description	
1.2 Features	
1.3 Application	
1.4 Package Dimension	
1.5 Product Parameters	
1.6 Bin Range Of Forward Voltage and Luminous Intensity (IF=20mA)	BIN
(IF=20mA)	
1.7 Typical Optical Characteristics Curves	
2. Packaging	
2.1 Packaging Specification	
2.1.1 Carrier Tape Dimension	11
2.1.2 Reel Dimension	11
2.1.3 Label Form Specification	12
2.2 Moisture Resistant Packing	
2.3 Cardboard Box	
2.4 Reliability Test Items And Conditions	
2.5 Criteria For Judging Damage	
3. SMT Reflow Soldering Instructions SMT	
3.1 SMT Reflow Soldering Instructions SMT	
4. Handling Precautions	
4.1 Handling Precautions	



# 1. Description

## 1.1 General Description

The Red source color devices are made with AlGaInp on Substrate Light Emitting Diode .  
P



## 1.4 Package Dimension

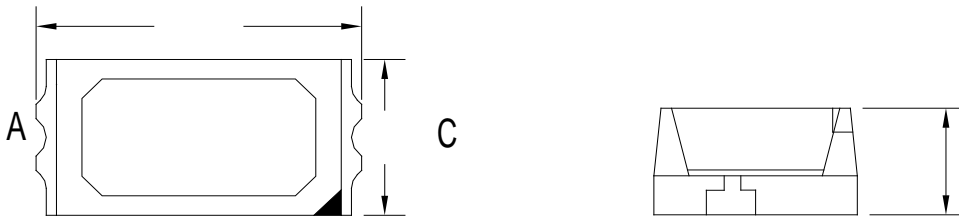
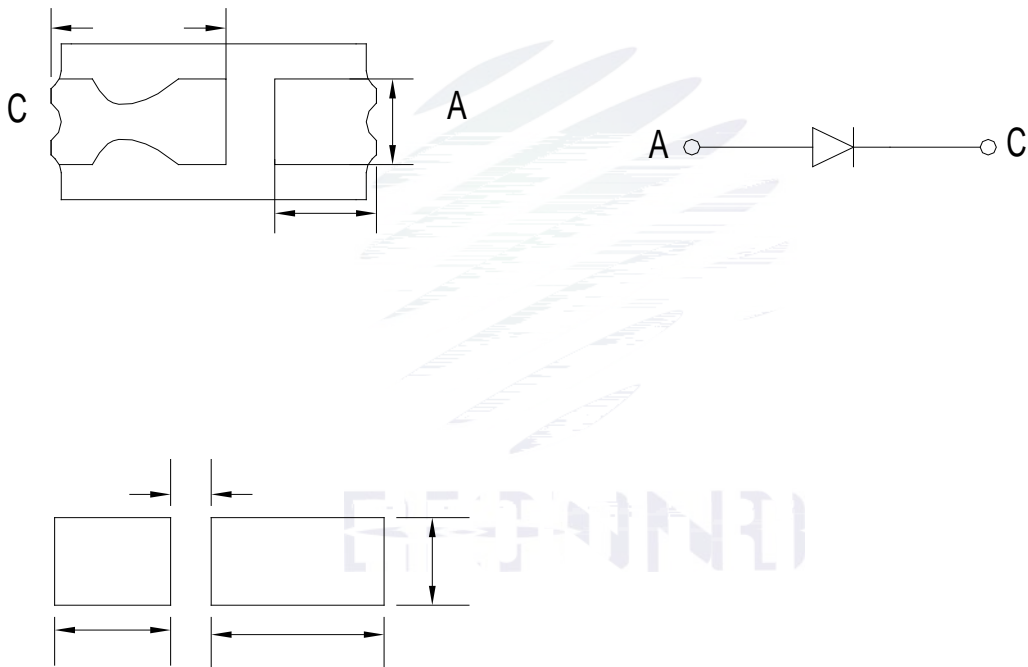

Fig. 1-1 Top View



### Notes

1. All dimensions units are millimeters.
2. All dimensions tolerances are  $\pm 0.2\text{mm}$  unless otherwise noted.



## 1.5 Product Parameters

Table 1-1 Electrical / Optical Characteristics at Ts=25°C

Item	Symbol	Test Condition	Value			Unit
			Min.	Typ.	Max.	
Forward Voltage	$V_F$	$I_F=20mA$	1.8	2.1	2.4	V
Reverse Current	$I_R$	$V_R=5V$	---	---	10	$\mu A$
Luminous Intensity	$I_V$	$I_F=20mA$	80	120	150	mcd
Dominant wavelength	$\lambda_d$	$I_F=20mA$	627.5	630	637.5	nm
Viewing Angle		$I_F=20mA$	---	120	---	deg
Thermal Resistance.	$R_{THJ-S}$	$I_F=20mA$	---	---	300	$^{\circ}W$

Table 1-2 Absolute Maximum Ratings at Ts=25°C

Parameter	Symbol	Rating	Units
Power Dissipation	$P_D$	78	mW
Forward Current	$I_F$	30	mA
Peak Forward Current	$I_{FP}$	100	mA
Reverse Voltage	$V_R$	5	V
Electrostatic Discharge (HBM)	$E_{SD}$	2000	V
Operating Temperature	$T_{OPR}$	-40 ~ +100	
Storage Temperature	$T_{STG}$	-40 ~ +100	
Junction Temperature	$T_J$	120	



Notes

1. 1/10 Duty cycle, 10ms pulse width.      10ms,      1/10.
2. The above forward voltage measurement allowance tolerance is  $\pm 0.1V$ .       $\pm 0.1V$ .
3. The above color coordinates measurement allowance tolerance is  $\pm 0.005$ .       $\pm 0.005$ .
4. The above luminous intensity measurement allowance tolerance  $\pm 10\%$ .  
 $\pm 10\%$ .
5. Care is to be taken that power dissipation does not exceed the absolute maximum rating of the product.
6. All measurements were made under the standardized environment of Refond.
7. When the LEDs are in operation the maximum current should be decided after measuring the package temperature, junction temperature should not exceed the maximum rate. LED
8. ESD yield is over 90% at 2000V ESD (HBM). ESD protection during products handing is needed. 90% LED  
 ESD2000V

### 1.6 Bin Range Of Forward Voltage and Luminous Intensity (IF=20mA)

**BIN (IF=20mA)**

Table 1-3

VF	B1	B2	C1	C2	D1	D2
	1.8-1.9	1.9-2.0	2.0-2.1	2.1-2.2	2.2-2.3	2.3-2.4
IV mcd	F2	G1	G2			
	80-100	100-120	120-150			
WD(nm)	F2	G1	G2	H1		
	627.5-630	630-632.5	632.5-635	635-637.5		



## 1.7 Typical Optical Characteristics Curves

Fig. 1-7 Forward Voltage Vs Forward Current

Fig. 1-8 Forward Current Vs Relative Intensity

Fig. 1-9 Solder Temperature Vs Relative Intensity

Fig. 1-10 Solder Temperature Vs Forward Current

Tj 120



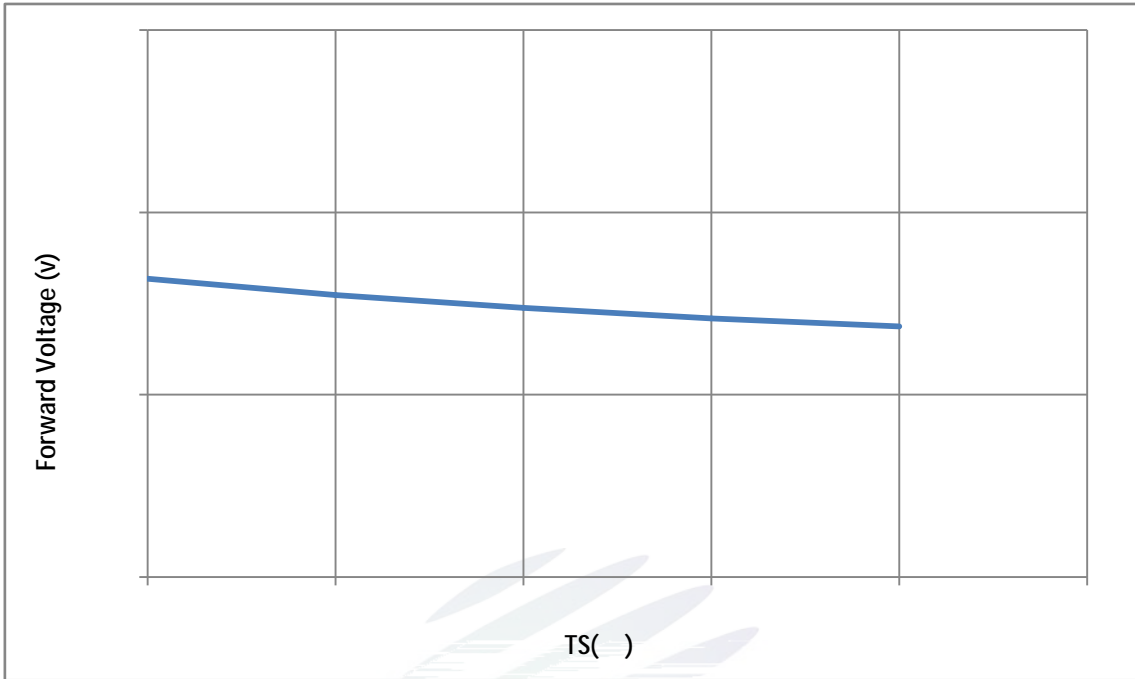

Fig. 1-11 Forward Voltage Vs Solder Temperature



Fig. 1-12 Radiation diagram



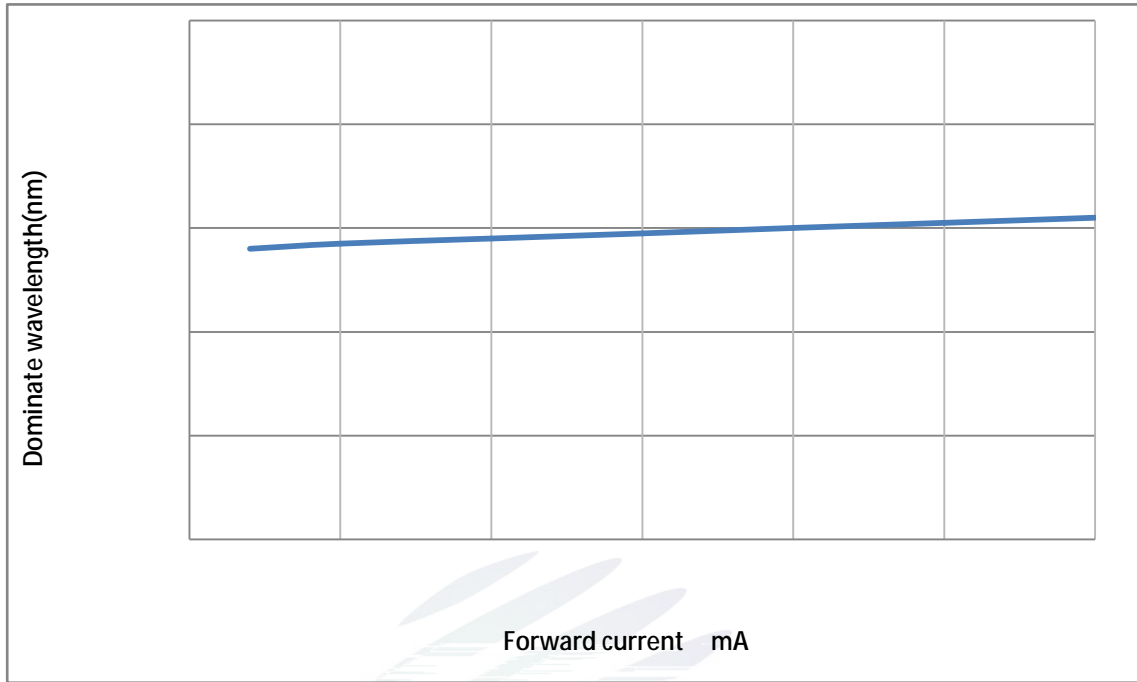

Fig. 1-13

(Ts=25°C)

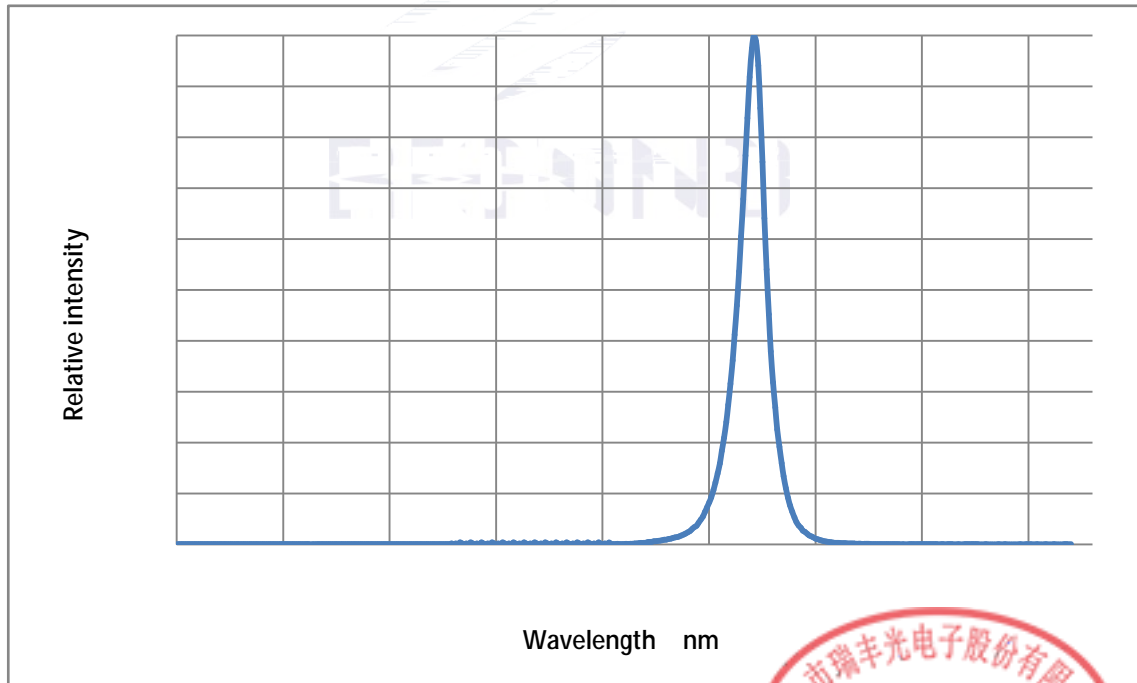

Fig. 1-14 Spectrum Distribution



## 2. Packaging

### 2.1 Packaging Specification

Package:4000pcs/reel.

#### 2.1.1Carrier Tape Dimension



REFOND

### 2.1.3 Label Form Specification

Table 2-2 Specification

PART NO.	Part Number
SPEC NO.	Spec Number
LOT NO.	Lot Number
BIN CODE	Bin Code
	Luminous flux
XY	Chromaticity Bin
$V_F$	Forward Voltage
WLD	Wavelength
QTY	Packing Quantity
DATE	Made Date

Fig. 2-3 Label Form Specification

### 2.2 Moisture Resistant Packing

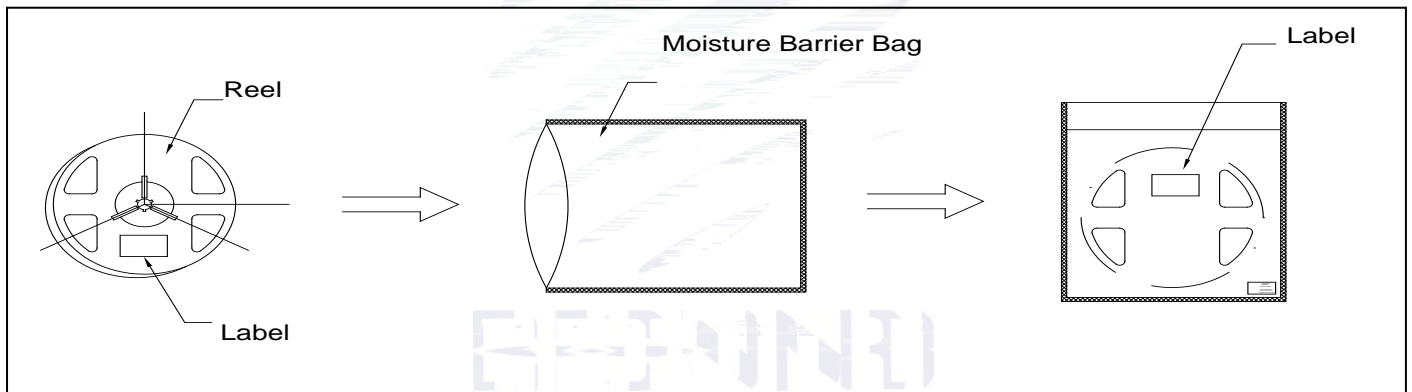

Fig.2-4 Moisture Resistant Packing

### 2.3 Cardboard Box

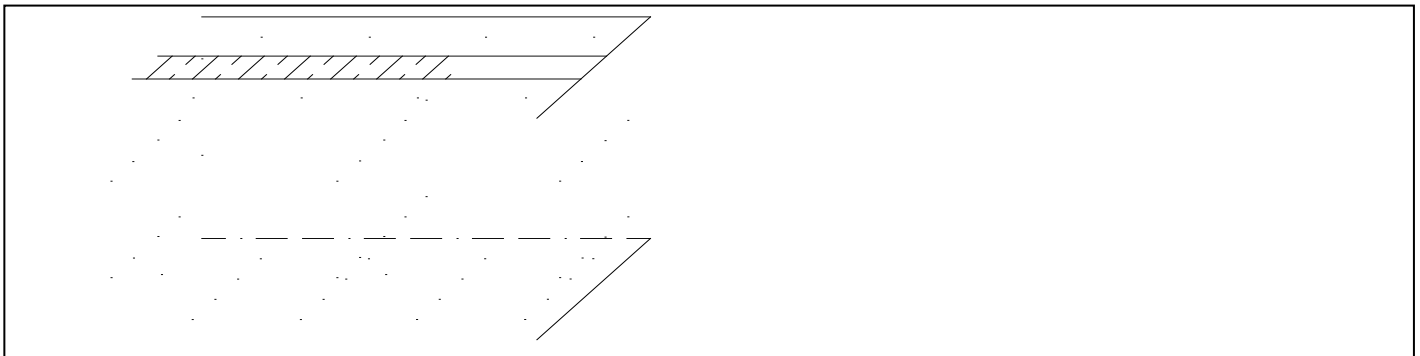

Fig.2- Cardboard Box

## 2.4 Reliability Test Items And Conditions

Table 2-3 Reliability Test Items And Conditions

Test Items	Ref. Standard	Test Condition	Time	Quantity	Ac/Re /
Reflow	JESD22-B106	Temp:260 max T=10 sec	2times	20pcs.	0/1
MSL2 2	JESD22-A113	85 / 60%RH	168 hrs.	20pcs.	0/1
Thermal Shock	JEITAED-4701 300307	-40 15min 10s 125 15min	1000 cycle	20pcs.	0/1
Life Test	JESD22-A108	Ta=85 If=20mA	1000hrs.	20pcs.	0/1
High Temperature High Humidity Life Test	JESD22-A101	85 / 85%RH If=20mA	1000hrs.	20pcs.	0/1



## 2.5 Criteria For Judging Damage

Table 2-4 Criteria For Judging Damage

Test Items	Symbol	Test Condition	Criteria For Judgement	
			Min.	Max.
Forward Voltage	$V_F$	$I_F=20mA$	-	U.S.L*)x1.1



### 3. SMT Reflow Soldering Instructions SMT

#### 3.1 SMT Reflow Soldering Instructions SMT

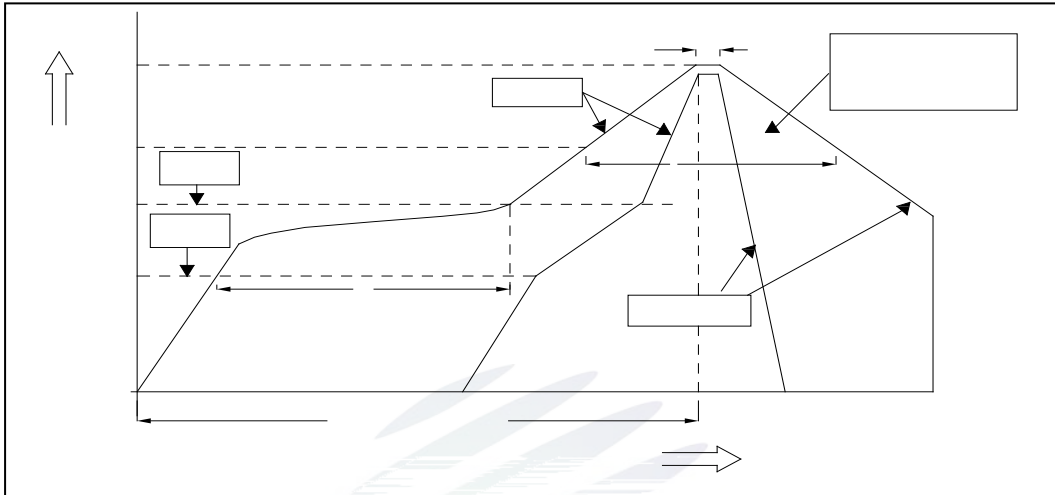

Fig.3-1 SMT Reflow Soldering Instructions SMT

Table 3-1 Reflow parameters

Average temperature rise speed	$T_{smax}$ $T_P$	3 °C/ s	Max 3 °C/ s
Preheating: minimum temperature	( $T_{smin}$ )	150 °C	
Preheating: Max temperature	( $T_{smax}$ )	200 °C	
Preheating: Time	$T_{smin}$ $T_{smax}$	60 - 120	60s-120s
Time limited to maintain high temperature: the temperature	( $T_L$ )	217 °C	
Time limited to maintain high temperature: The Time	( $t_L$ )	60	Max 60s
Peak /Classification of temperature:	/ ( $T_P$ )	260 °C	
Time limit classification of peak temperature time	$t_p$	10	Max 10s
( $T_P$ ) 5 °C	Hold time within 5 °C with the actual peak temperature ( $T_P$ )	30	Max 30s
Cooling speed		6 °C/ s	Max 6 °C/ s
25 °C	Needed time from 25 °C to $T_p$	8	Max 8 minutes







## 4. Handling Precautions

### 4.1 Handling Precautions

(1) LED operating environment and sulfur element composition cannot be over 100PPM in the LED mating usage material. This is provided for informational purposes only and is not a warranty or endorsement.

LED 100PPM.

(2) In order to prevent external material from getting into the inside of LED, which may cause the malfunction of LED, the single content of Bromine element is required to be less than 900PPM, the single content of Chlorine element is required to be less than 900PPM, the total content of Bromine element and Chlorine element in the external materials of the application products is required to be less than 1500PPM. This is provided for informational purposes only and is not a warranty or endorsement.

	LED	LED
	900PPM	900PPM
1500PPM		

(3) VOCs (Volatile organic compounds) emitted from materials used in the construction of fixtures can penetrate silicone encapsulants of LEDs and discolor when exposed to heat and photonic energy. The result can be a significant loss of light output from the fixture. Knowledge of the properties of the materials selected to be used in the construction of fixtures can help prevent these issues. Refond advises against the use of any chemicals or materials that have been found or are suspected to have an adverse effect on device performance or reliability. To verify compatibility, Refond recommends that all chemicals and materials be tested in the specific application and environment for which they are intended to be used. Attaching LEDs, do not use adhesives that outgas organic vapor.

LED LED

LED

(4) Handle the component along the side surface by using forceps or appropriate tools; Do not directly touch or handle the silicone lens surface, it may damage the internal circuitry.



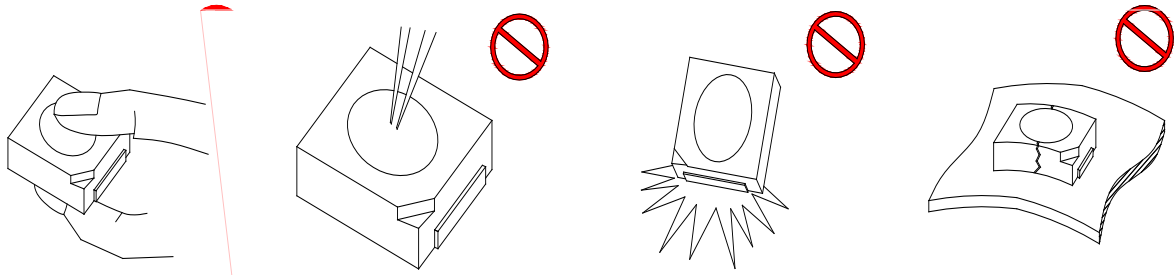

Fig 4-1 Handling Precautions

(5) In designing a circuit, the current through each LED can not exceed the absolute maximum rating specified for each LED. In the meanwhile, resistors for protection should be applied, otherwise slight voltage shift will cause big current change, burn out may happen. The driving circuit must be designed to allow forward voltage only when it is ON or OFF. If the reverse voltage is applied to LED, migration can be generated resulting in LED damage.

LED

LED

(6) Thermal Design is paramount importance because heat generation may result in the Characteristics decline, such as brightness decreased, Color change and so on. Please consider the heat generation of the LEDs when making the system design.

LED

(7) Compared to standard encapsulants, silicone is generally softer, and the surface is more likely to attract dust, requiring special care during processing. In cases where a minimal level of dirt and dust particles cannot be guaranteed, a suitable cleaning solution must be applied to the surface after the soldering of components. Refond suggests using isopropyl alcohol for cleaning. In case other solvents are used, it must be assured that these solvents do not dissolve the package or resin. Ultrasonic cleaning is not recommended. Ultrasonic cleaning may cause damage to the LED.

LED

Table 4-1 Storage

Conditions		Temperature	Humidity	Time
Storage	Before Opening Aluminum Bag	30	75%	Within 1 Year From Date
	After Opening Aluminum Bag	30	60%	Recommended for use within 24 hours  24H
Baking		60± 5	-	24hours  24

(8) If the moisture absorbent material silica gel has faded away or the LEDs have exceeded the storage time, baking treatment should be performed after unpacking and based on the following condition 60± 5 for above 24 hours.

60± 5      24

If the package is flatulence or damaged, please notify the sales staff to assist.

(9) Similar to most Solid state devices; LEDs are sensitive to Electro-Static Discharge (ESD) and Electrical Over Stress (EOS).  
LED

(10) Other points for attention, please refer to our relevant information.



Date	Revisor	Version	Verifier	Remarks
2022/08/20	Lu Xian	E0	Zhu yiming	
2022/12/28	Lu Xian	E1	Zhu yiming	





www.refond.com

REFOND

Declare

This specification is written both in English and in Chinese and the latter is formal.

