

Contents naE6

1. Description 'a1w'•}O	3.....
1.1 General Description 'a1wL½•£.....	3.....
1.2 Features 'a1wfµE,,	3.....
1.3 Application 'a1wC¾k=.....	3.....
1.4 Package Dimension ? '3?o?	4.....
1.5 Product Parameters 'a1w/iO"	5.....
1.6 Bin Range Of Forward Voltage and Luminous Flux (IF=1000mA)kO/"&x](PÈ- BIN ... '55 (IF=1000mA).....	6.....
1.7 Typical optical characteristics curves ,)6 +Õ=ÖfµF•R<}A.....	8....
2. Packaging 'a1w.«'3	12.....
2.1 Packaging Specification .«'3" TT	12.....
2.1.1 Carrier Tape Dimension œ¿C ?o?.....	12.....
2.1.2 Reel Dimension /wn9?o?	12.....
2.1.3 Label Form Specification SûvŠ" TT.....	13....
2.3 Cardboard Box .«'3}:vò	13.....
2.4 Reliability Test Items And Conditions)L™FF•]5— ñàna/úRõ'Ý.....	14.
2.5 Criteria For Judging Damage 8ßOj-<>ASû,¥.....	15....
3.SMT Reflow Soldering Instructions SMT › vD a φ	16...
3.1 SMT Reflow Soldering Instructions SMT 5](cÒ—9PÈ.....	16...
4. Handling Precautions 'a1w(a'k=\µH '2-à	18.....
4.1 Handling Precautions 'a1w(a'k=\µH '2-à	18.....

1. Description 'a1w'•}O

1.1 GeneralDescription'a1wL½•£

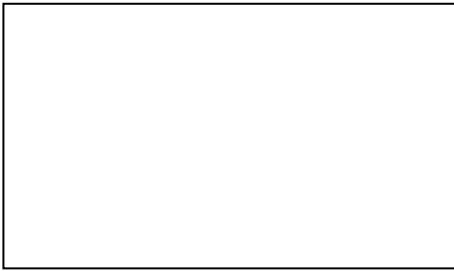

This product uses the ceramics package, it has a high reliability. it also be widely application for Automotive Exterior Lighting. Size(mm): 2.00X1.60X0.80mm.

R¥'a1w;wk=©2jØ? '3}US,æ{03« F•± . C\OE•Xk='5œ"8ad'PE.'a1w?o? ö;2.00X 1.60X0.80mm

1.2 Features 'a1wfµE,,

y Ceramic Package. ©2jØ? '3

yHigh Power Output and High Luminance. ± . hg1\$± 'mCP

yPb -free reflow soldering application. P}§ 5)(cÖC¾k=

yMoisture sensitive level:Level2. "È`Ðv }ö;Level 2

y Compliance with RoHS and REACH. ux0V 3 P)1\$ 3 & " \$)'³[

y Qualifications: The product qualification test plan is based on the guidelines of AEC-Q102 Stress Test Qualification for Automotive Grade Discrete Semiconductors™4TTö;'a1w™4TT]5—
—æ-"6Ç'5 " & \$2 [üœ"})- u(/1? (dC¾.]5—™4TT,¥--

1.3 Application 'a1wC¾k=

yAutomotive Exterior Lighting, Daytime Running Lamp, Headlamp, Fog lamp. œ"8ad'PEæ{9uP^

•db\$æ{œ"8Db\$æ{^:b\$

1.4 Package Dimension ? '3?o?

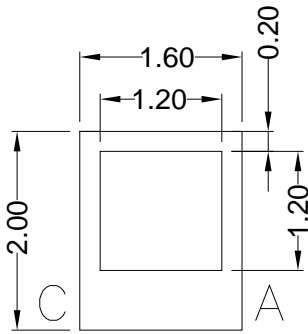

Fig.1-1 Top View !"M'?ö .

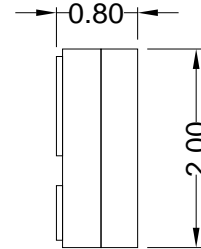

Fig.1-2 Side View xM'?ö .

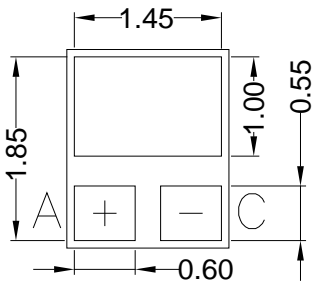

Fig.1-3 Bottom View 6üM'?ö .

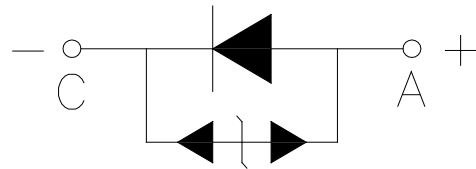

Fig.1-4 Polarity ± W

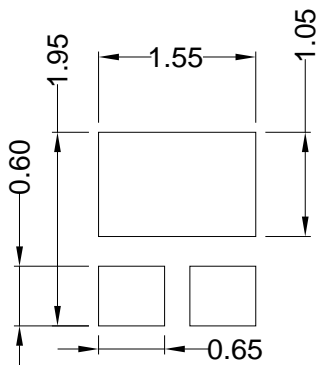

Fig.1-5 Soldering Patterns Ø9€':-

Notes 8Š\pö;

All dimensions units are millimeters. J>Rc?o? Sû\p/@(Y&'[x)

All dimensions tolerances are r0.2mm unless otherwise noted. © fμ-FSû\p8ªæ{J>Rc?o? , Bμ&' p [x)

1.5 Product Parameters 'a1w/iO"

Table 1-1 Electrical / Optical Characteristics at Ts=25°C kOF•&x+Ö=ÖfµF•

Item —àna	Symbol ux0?	Test Condition]5— Rō'Ý	Value			Unit /@(Y
			Min. æwRR?-)éæ	Typ æw,)6)éæx	Max. æwRR8Ð)éæ	
Forward Voltage æwYû0bkO/"æx	V _F	I _F =1000mA	2.8	---	3.4	V
Reverse Current æw`)kO](æx	I _R	V _R =5V	---	---	10	µA
luminous flux (#Øb©d^)	-	I _F =1000mA	360	---	460	lm
Viewing Angle æw0 +Ö"-CPæx		I _F =1000mA	---	120	---	deg
Color Rendering Index Q „€KwO"	R _a	I _F =1000mA	---	---	---	---
Thermal Resistance. æwçs"Öæx	R _{THJ-S}	I _F =1000mA	---	3.1	4.1	/W

Table 1-2 Absolute Maximum Ratings at Ts=25°C }_? RR8Ð)é

Parameteræw/iO"æx	Symbolæwux0?æ	Ratingæw)éæx	Unitsæw/@(Yæ
Power Dissipation æw. •ræx	P _D	5100	mW
Forward Current æwYû0bkO](æx	I _F	1500	mA
Peak Forward Current æw@½)ékO](æx	I _{FP}	2000	mA
Reverse Voltage æw/ÿ0bkO/"æx	V _R	5	V
Electrostatic Discharge (HBM)æw^ÿkOæx	E _{SD}	8000	V
Operating Temperature æwN](r^)CPæx	T _{OPR}	-40 ~ +125	B]
Storage Temperature æw^=,^)CPæx	T _{STG}	-40 ~ +125	B]
Junction Temperature æwJ^æx	T _J	150	B]

Notes 8Š\pö;

1. 1/10 Duty cycle, 10ms pulse width. •a>^10ms 0iR•1/10.
2. The above forward voltage measurement allowance tolerance is ±0.1V. 'Ä&sJ>r kO/"j5j€—4Bμ ±0.1V
3. The above color coordinates measurement allowance tolerance is± 0.005. 'Ä&sJ>r 5ÂSûj5j€—4Bμ p0.005
4. The above luminous flux measurement allowance tolerance ±10%. &s•£+Öž j€m,j5— +Ë-ý, Bμ±10%.
5. Care is to be taken that power dissipation does not exceed the absolute maximum rating of the product. (ak= . hg&v•J™„•B“ >Am,RR8Đ)é o
6. All measurements were made under the standardized environment of Refond. J>Rc]5— ŸêPý6Ç'5i°&ah;Rcm, Sû,¥]5— C,05 o
7. When the LEDs are in operation the maximum current should be decided after measuring the package temperaturep»junction temperature should not exceed the maximum rate - &(‰=m,RR8ĐkO](a='3TOL O"čš Rđ'ÝpÁ>Aæ{}U^)&v•J™„•BRR8Đ)é o
8. ESD yield is over 90% at 8000V ESD (HBM). ESD protection during products handing is needed. m, - & % ž •B'f(dW·D- & 4 % 7]5— 5^N|(rPž—<|pH aýkO"ËJá o

1.6 Bin Range Of Forward Voltage and Luminous Flux (IF= 1000mA)kO/"&x](PÈ - BIN ... 55F=1000mA)

Table 1-3

V _F H? H	G0	H0	I0	
		2.8-3.0	3.0-3.2	3.2-3.4
- (lm)	BG	BH	FD	FE
	360-380	380-400	400-430	430-460

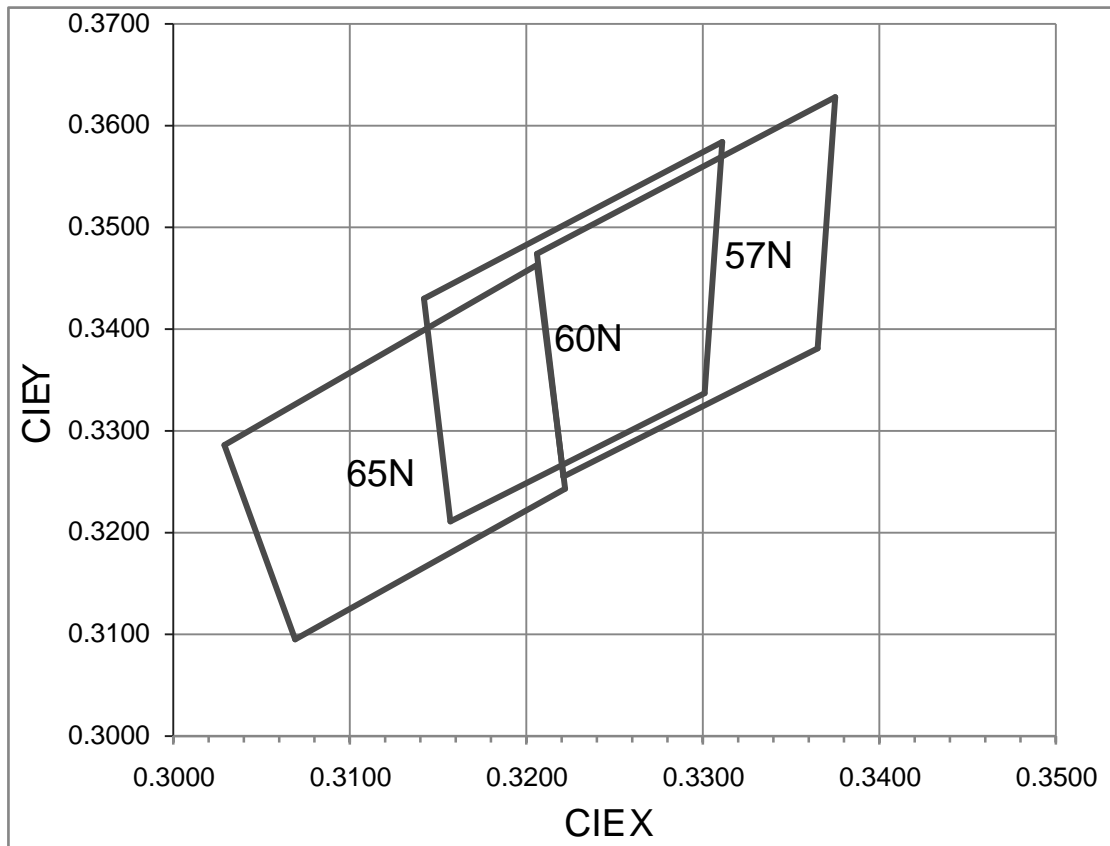

Bin data H

BIN CODE	X1	Y1	X2	Y2	X3	Y3	X4	Y4
57N	0.3221	0.3255	0.3206	0.3474	0.3375	0.3628	0.3365	0.3381
60N	0.3157	0.3211	0.3142	0.3430	0.3311	0.3584	0.3301	0.3337
65N	0.3029	0.3286	0.3206	0.3463	0.3222	0.3243	0.3069	0.3095

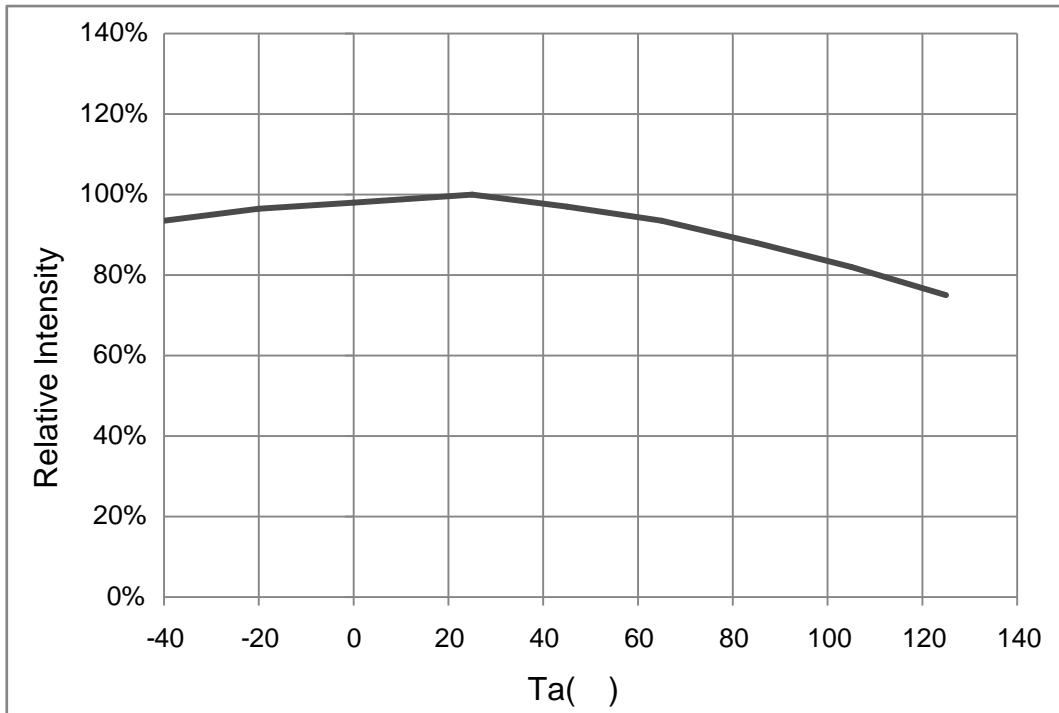

Fig 1-8 Ts Temperature Vs Relative Intensity $v \times f^{\wedge} C p \& x n q ? + \ddot{O} E \mu F \cdot R < \} A$

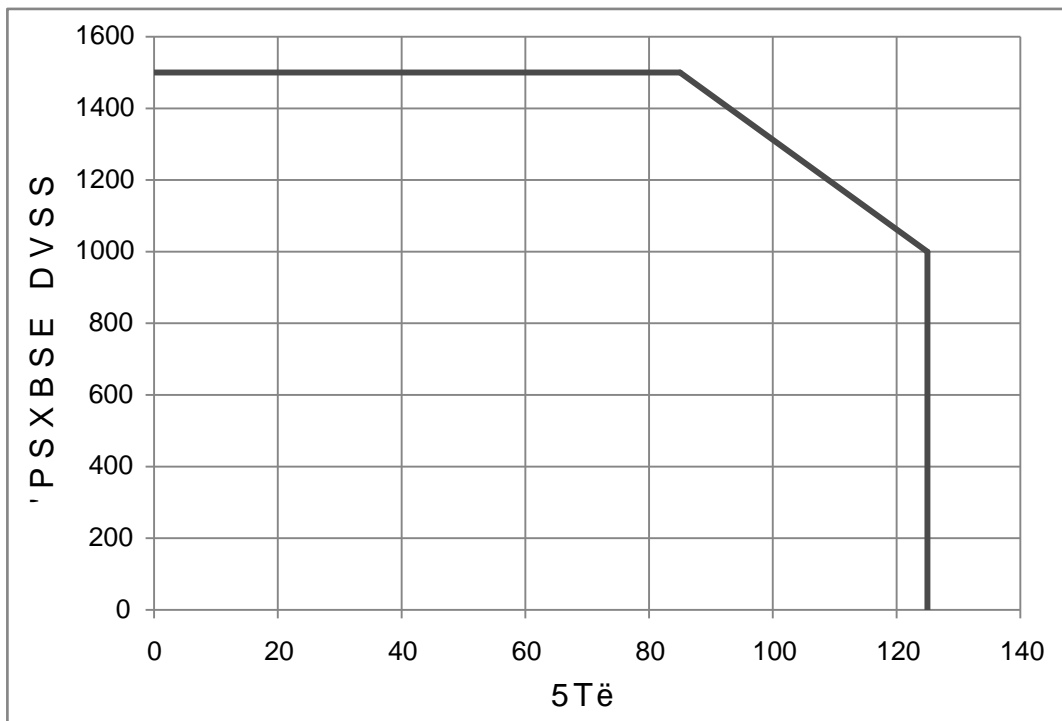

Fig 1-9 Ts Temperature Vs Forward Current $v \times f^{\wedge} C p \& x Y \ddot{u} 0 b k O \} (\mu F \cdot R < \} A$

Tj0150 ä

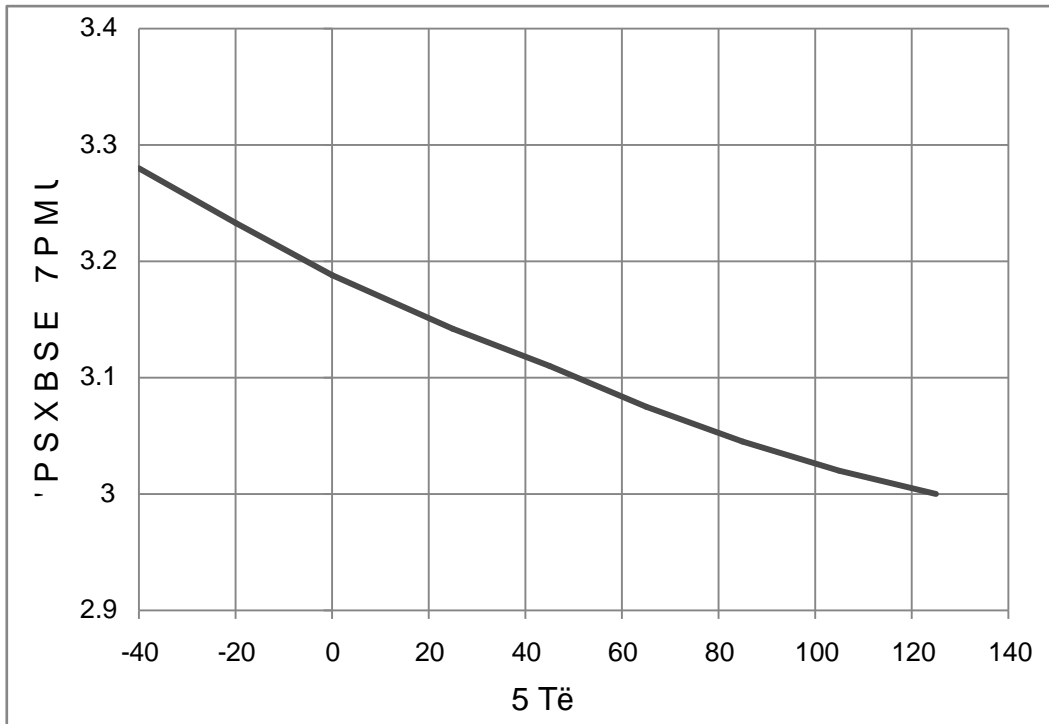

Fig. 1-10 Forward Voltage Vs Solder Temperature

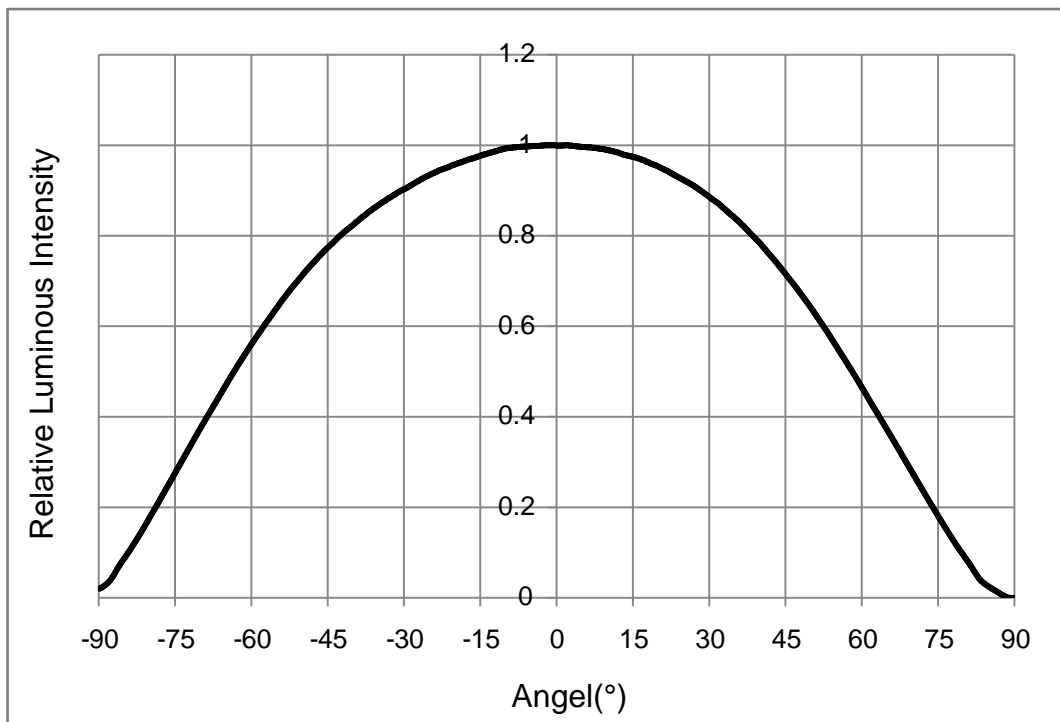

Fig 1-11 Radiation diagram

Fig. 1-12 Chromaticity Coordinate Vs Solder Temperature,,€5ÂSû&xvx•f^CbfµF•R<}A

Fig 1-13 Spectrum Distribution +Ö—v- BÔfµF•R<}A

2. Packaging 'a1w.«'3

2.1 Packaging Specification .«'3" TT

Package:4000pcs/reel..«'3Zæ/w Q DoT

2.1.1 Carrier Tape Dimension œ¿C ?o?

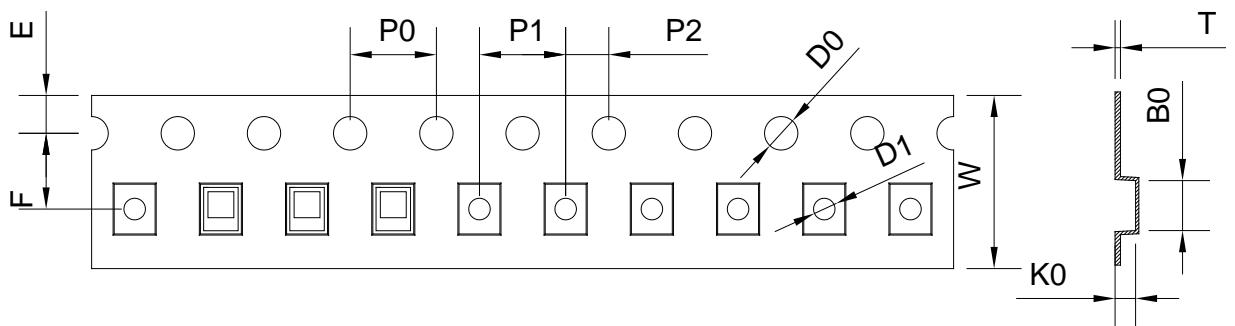

symbol	A0	B0	K0	P0	P1	P2
Spec	1.80±0.1	2.30±0.1	0.95±0.1	4.00±0.1	4.00±0.1	2.00±0.05
symbol	W	T	E	F	D0	D1
Spec	8.00±0.1	0.20±0.05	1.75±0.1	3.50±0.1	1.50±0.1	1.10±0.1

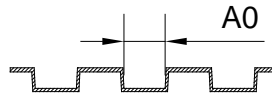

Fig.2-1 Carrier Tape Dimension œ¿C ?o?

2.1.2 Reel Dimension /wn9?o?

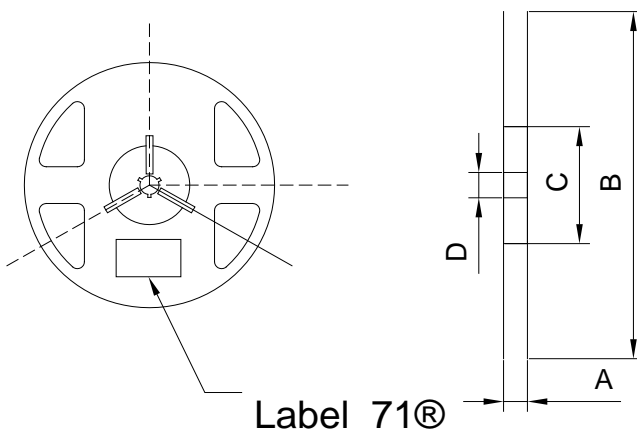

Fig.2-2 Reel Dimension /wn9?o?

Table 2-1 Dimension ?o?

A	12±0.3mm
B	180±2mm
C	60.0±1mm
D	13.0±0.2mm

Notes 8Š\œö;

The tolerances unless mentioned ±0.1mm. Unit : mm <•pÉ6Ö<•! -- â±0. 1;“L æ{ +â+ "ý öpÉ;“L o

2.1.3 Label Form Specification SûvŠ“ TT

Table 2-2 Label Form Specification SûvŠ“ TT

PART NO	Part Number 1w0\
SPEC NO	Spec Number “ TT
LOT NO	Lot Number J Yf0?
BIN CODE	Bin Code „€/
N	Luminous flux v Â
X/Y	Chromaticity Bin, Ø
V _F	Forward Voltage Yû0bkO/“
QTY	Packing Quantity O”j€
DATE	Made Date k0'aP^R•

Fig 2-3 Label Form Specification SûvŠ“ TT

2.2 Moisture Resistant Packing “È`Đ. «‘3

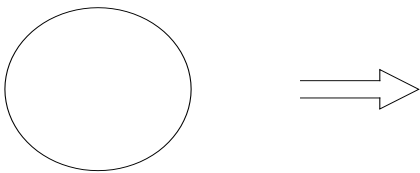

Fig.2-4 Moisture Resistant Packing “È`Đ. «‘3

2.3 Cardboard Box .«‘3}:vò

Fig.2-5 Cardboard Box .«‘3}:vò

2.4 Reliability Test Items And Conditions)L™FF•]5— -àna/úRõ'Ý

Table 2-3 Reliability Test Items And Conditions)L™FF•]5— -àna/úRõ'Ý

Test Items -àna	Ref.Standard /i•LSÙ,¥	Test Condition]5— Rõ'Ý	Time Pž",	Quantity O"i€	Ac/Re LyOPK(OP
Reflow 5](cÒ	JESD22-B106	Temp:260 ë max T=10 sec	2times	20pcs.	0/1
MSL2 "È`Đv))2	JESD22-A113	85 ë/ 60%RH	168 hrs.	20pcs.	0/1
Thermal Shock ,±čš,~-	JEITAED-4701 300307	-40 ë 15min 9 ;10s 125 ë 15min	1000 cycle	20pcs.	0/1
Life Test ± ^)]5—	JESD22-A108	Ta=125 ë If=1000mA	1000hrs.	20pcs.	0/1
High Temperature High Humidity Life Test ± ^)± _*]5—	JESD22-A101	85 ë/ 85%RH If=1000mA	1000hrs.	20pcs.	0/1

2.5 Criteria For Judging Damage 8βOj-<>ASû,¥

Table Criteria For Judging Damage 8βOj-<>ASû,¥

Test Items ~àna	Symbol ux0?	Test Condition]5— Rō'Ý	Criteria For Judgement -<>ASû,¥	
			Min. RR?-	Max. RR8Đ
Forward Voltage Yû0bkO/“	V_F	$I_F=1000mA$	-	U.S.L*)x1.1
Reverse Current /ÿ0bkO](I_R	$V_R = 5V$	-	U.S.L*)x2.0
Luminous Flux œ3û5	ž	$I_F=1000mA$	L.S.L*)x0.7	-

Notes 8Š\pö;

1.U.S.L: Upper standard level “ TT&s”ó L.S.L: Lower standard level “ TT&t”ó

2. The above reliability tests is based on the verification of a single/strip LED of Refond's existing experimental platform, the reliability experiment was taken under good heat dissipation conditions. when customers applies the LED to the series and parallel circuit, should take consideration of all the factors such as the current, voltage distribution, heat dissipation and others. 'Ä&s03« F•]5— Pý6Ç'5i°&ªh;Rc>J°%C,05/@-ßō - & %5^„(9iO” cšRō'Ý°%— &tm,}USS o>PJ*un? & %6¾k='5&® nC†•ë)Aš Pžæ{ª=fH•d— (.kO](nkO/“- • nO”cšv “|~ÿ o

3.The technical information shown in the data sheets is limited to the typical characteristics and circuit examples of the referenced products. It does not constitute the warranting of industrial property nor the granting of any license. 'Ä&sJ@R©O“L “&'a1wm,,)6)éæ{0+(r&'i•Læ{&v(r&'ã(fC¾k=Rō'Ý/úC¾k=P0D-m,)B— o

3.SMT Reflow Soldering Instructions SMT š WD y f

3.1 SMT Reflow Soldering Instructions SMT 5](cÒ—9PÈ

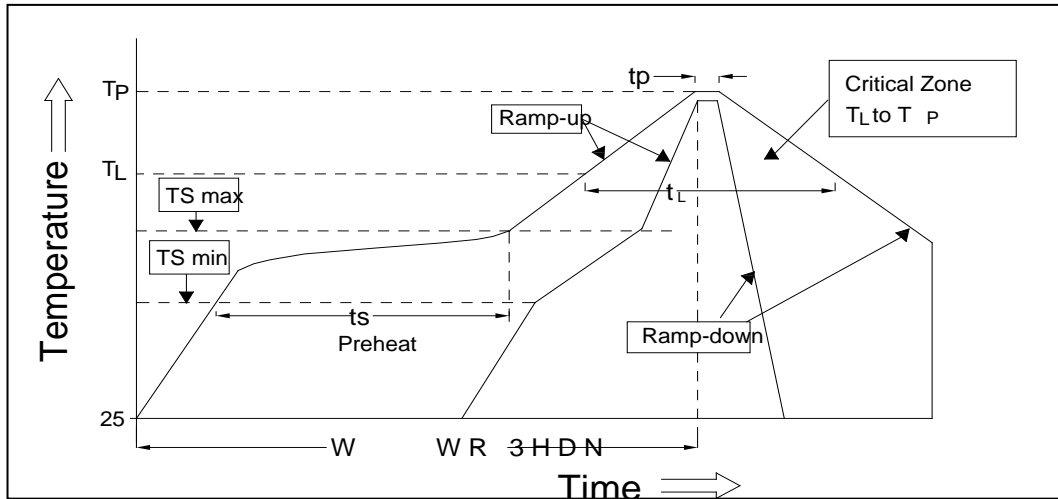

Fig.3-1 SMT Reflow Soldering Instructions SMT 5](cÒ—9PÈ

Table 3-1 Reflow parameters #q': ò

Average temperature rise speed $C_{50} / (T_{max} - T_{min})$	$RR \pm 3 \text{ } ^\circ\text{C/s}$ Max 3 $^\circ\text{C/s}$
Preheating: minimum temperature T_{min}	150 $^\circ\text{C}$
Preheating: Max temperature T_{max}	200 $^\circ\text{C}$
Preheating: Time t_s	60 - 120s 60s-120s
Time limited to maintain high temperature: the temperature T_L	217 $^\circ\text{C}$
Time limited to maintain high temperature: The Time t_L	$RR \leq 60s$ Max 60s
Peak /Classification of temperature: T_p	260 $^\circ\text{C}$
Time limit classification of peak temperature time t_p	$RR \leq 10s$ Max 10s
Hold time within 5 $^\circ\text{C}$ with the actual peak temperature (T_p)	$RR \leq 30s$ Max 30s
Cooling speed	$RR \pm 6 \text{ } ^\circ\text{C/s}$ Max 6 $^\circ\text{C/s}$
Needed time from 25 $^\circ\text{C}$ to T_p	$RR \leq 8 \text{ min}$ Max 8 minutes

4. Handling Precautions 'a1w(ak=\#H '2-à

4.1 Handling Precautions 'a1w(ak=\#H '2-à

(1) LED operating environment and sulfur element composition cannot be over 100PPM in the LED mating usage material. This is provided for informational purposes only and is not a warranty or endorsement. LED B'

(rh 7/ú&x - & %Ó •m,RpOñ&¥p»+Ëz /ú.Ê0VfYÍl'ç&v03™,,•B 1 1 .•o0+Pý&g&jDŠ-óæ{&v(r'ã(f1w™ K)B o

(2) In order to prevent external material from getting into the inside of LED, which may cause the malfunction of LED, the single content of Bromine element is required to be less than 900PPM, the single content of Chlorine element is required to be less than 900PPM, the total content of Bromine element and Chlorine element in the external materials of the application products is required to be less than 1500PPM. This is provided for informational purposes only and is not a warranty or endorsement. &'+"ÈYú8ªkrfY™ •s, - & %ÿË

'Äž#lí - & %ñ,L (æ{J>8...h 7/úJ>k=9 'Yv v æ{/@&gm, f+Ëz 0Žj€'3[?-'5 1 1 .æ{/@&g[+Ëz 0Žj€'3[?-'5
1 1 .æ{ f+Ëz &x[+Ëz Fª0Žj€Eó-â?-'5 1 1 . •o0+Pý&g&jDŠ-óæ{&v(r'ã(f1w™ K)B o

(3) VOCs (Volatile organic compounds) emitted from materials used in the construction of fixtures can penetrate silicone encapsulants of LEDs and discolor when exposed to heat and photonic energy. The result can be a significant loss of light output from the fixture. Knowledge of the properties of the materials selected to be used in the construction of fixtures can help prevent these issues. Refond advises against the use of any chemicals or materials that have been found or are suspected to have an adverse effect on device performance or reliability. To verify compatibility, Refond recommends that all chemicals and materials be tested in the specific application and environment for which they are intended to be used. Attaching LEDs, do not use adhesives that outgas organic vapor. Cªk=9 'Y&¥m,K!0 F•fY™ (^w•ó-L - & %ÿËæ{5^ž kO'ak0+Õ=©/úcšm,Rõ'Y

&tæ{(? f] - & %ñ,,æ{s•ž#lí&šj~+Õ••æ{Lç-x'+R9 'YRbOñ•J8çY +Y'ak0•o'H"-y oi°&ª/y? (ªk='ã(f? - & %
4<'Ym,F•Jlô•O03« F•Rc>rm,fY™ lôRbOñæ{&v vx•o'HRbOñPýBª)Q— >J+m,•nPý""FUKßRc>r oi'f fµ>Am,k=ž 1\$
(ªk=h 7-æ{i°&ªDŠ-ó? J>Rcm,fY™ 1\$RbOñ•s•dnq>,F•m,]5— o5™\$ª3& ðž)«æ{&vª(ªk=•J'ak0RcR¼K!0 F•fY™(d
m,xè)U-k o

(4) Handle the component along the side surface by using forceps or appropriate tools; Do not directly touch or Handle the silicone lens surface, it may damage the internal circuitry. ž •B(ªk=•ÓE2m,B",('çRbOñ(é« 8è0 æ{&v03
nLlyk=J[lô?:\$Xj,,?©/"•8(d••« æ{> 03•J(L 5Á,;ÿËkOš o

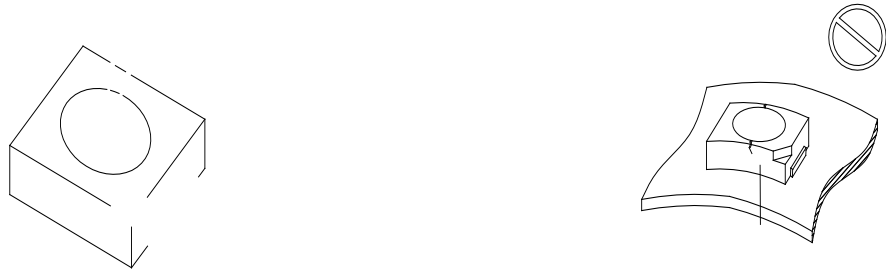

Fig 4-1 Cautions

(5) In designing a circuit, the current through each LED can not exceed the absolute maximum rating specified for each LED. In the meanwhile, resistors for protection should be applied, otherwise slight voltage shift will cause big current change, burn out may happen. The driving circuit must be designed to allow forward voltage only when it is ON or OFF. If the reverse voltage is applied to LED, migration can be generated resulting in LED damage.

(6) Thermal Design is paramount importance because heat generation may result in the Characteristics decline, such as brightness decreased, Color change and so on. Please consider the heat generation of the LEDs when making the system design.

(7) Compared to standard encapsulants, silicone is generally softer, and the surface is more likely to attract dust, requiring special care during processing. In cases where a minimal level of dirt and dust particles cannot be guaranteed, a suitable cleaning solution must be applied to the surface after the soldering of components. Refond suggests using isopropyl alcohol for cleaning. In case other solvents are used, it must be assured that these solvents do not dissolve the package or resin. Ultrasonic cleaning is not recommended. Ultrasonic cleaning may cause damage to the LED.

Table 4-1 Storage ^{°=,}

Conditions		Temperature	Humidity	Time
s+x«		^*Cp	_*Cp	Pž,
Storage ø ^	Before Opening Aluminum Bag K.«-x	ö030 ë	ö075%	Within 1 Year From Date &gCf,;
	After Opening Aluminum Bag K.«0_	ö030 ë	ö060%	Recommended for use within 24 hours DŠ-ó24?-Pž,;(ak=
Baking cwc•		60 p5 ë	-	ö124hours 8Đ'524?-Pž

(8) If the moisture absorbent materialp· silica gelp, has faded away or the LEDs have exceeded the storage time, baking treatment should be performed after unpacking and based on the following conditionp· 60±5p, W for above 24 hours.9uSSC•e•-klô.«'38ßOjæ{Iô•O'a1w&vux0V'Ä&sRcOj*°=,Rõ'Ýæ{ª=K.«0_•s•dcwc•æ{cwc•Rõ'Ýö; p ëæ{8Đ'5 ?-Pž o

If the package is flatulence or damaged, please notify the sales staff to assist.9uSS.«'3€Æ[^\ô•OpvL æ{—<ž oü\$H 2 'f0x/8. 8...i o

(9) Similar to most Solid state devices; LEDs are sensitive to Electro-Static Discharge (ESD) and Electrical Over Stress (EOS). *ø,&'-m, /1? (dkO=©4<'Ý&gTKæ{ - &?%ýkO•B](- tl« C"OuH-æ{ª='3* 9i"ÈJá o

(10) Other points for attention, please refer to our relevant information.,&> \mH '2-à—</id'i°&anq,"™4Oñ o

Version History/)-ç/Ž07

DateP^R•	Revisor)-ç•O	Versionf\Ŧ€	Verifier>NTM	Remarks8Š\p
2022/05/10	0i™ Xian Zhou	E0	R«n\$PÈ Zhu Yiming	P 0 •d New issue
2023/09/28	0i™ Xian Zhou	E1	R«n\$PÈ Zhu Yiming	f\Ŧ€Ŧ?P Version update

www.refond.com

Declare kMPÈ

This specification is written both in English and in Chinese and the latter is formal.

'a1w“ TT&ü'Ä&¥...%oOÒP0D-èü,VoRc,~tr'Ä&¥OÒfR¥&'1,¥o