

REFOND P/N

RE30A0-IPX-FR

R&D

Mass Product

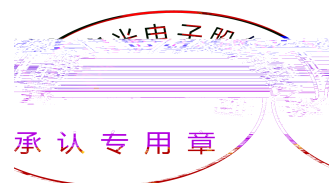

Contents

1. Description	3
1.1 General Description	3
1.2 Features	3
1.3 Application	3
1.4 Package Dimension	3
1.5 Product Parameters	5
1.5 Bin Range Of Forward Voltage and Total Radiant Flux (IF=500mA)	BIN
(IF=500mA)	5
1.6 Typical optical characteristics curves	7
2. Packaging	10
2.1 Packaging Specification	10
2.1.1 Carrier Tape Dimension	10
2.1.2 Reel Dimension	10
2.1.3 Label Form Specification	11
2.2 Moisture Resistant Packing	11
2.3 Cardboard Box 4	11
2.4 Reliability Test Items And Conditions	12
2.5 Criteria For Judging Damage	13
3. SMT Reflow Soldering Instructions SMT	14
3.1 SMT Reflow Soldering Instructions SMT	14
4. Handling Precautions	16

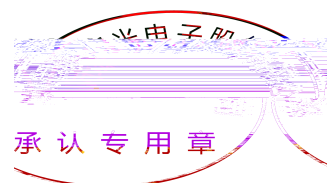

General Description

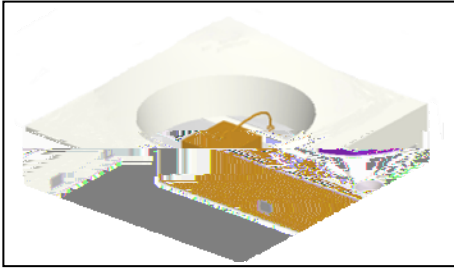

This product uses the EMC package, it has a high reliability. it also be widely application for security monitoring and senso. Size(mm): 3.00X3.00X2.53mm.

EMC

3.00X3.00X0.52mm

950nm free of red.

Low forward voltage.

Peak wavelength $\lambda_p=950\text{nm}$. $\lambda_p=950\text{nm}$

Pb-free reflow soldering application.

Moisture sensitive level: Level 3. Level 3

RoHS compliant. RoHS

Surveillance systems.

Infrared illumination for cameras.

Machine vision systems.

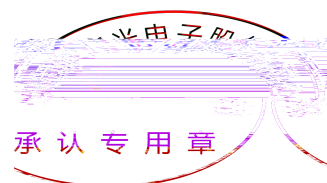

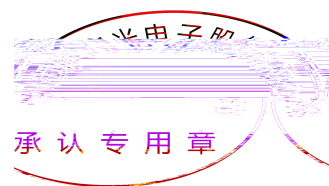
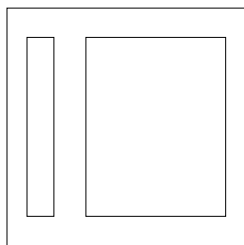
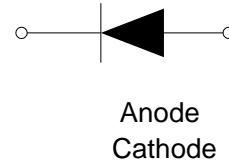
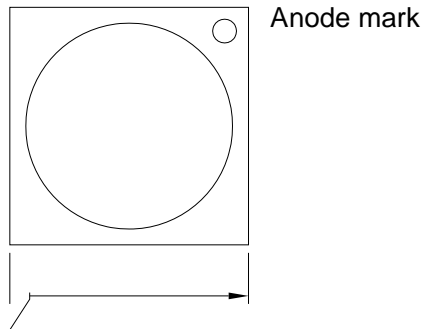

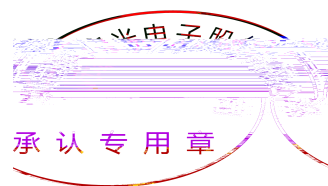

Table 1-2 Absolute Maximum Ratings at Ts=25°C

Parameter	Symbol	Rating	Units
Power Dissipation	P_D	0.85	W
Forward Current	I_F	500	mA
Reverse Voltage	V_R	5	V
Electrostatic Discharge (HBM)	E_{SD}	2000	V
Operating Temperature	T_{OPR}	-40 ~ +85	
Storage Temperature	T_{OPR}	-40 ~ +100	
Junction Temperature	T_J	95	

Notes

1. The above forward voltage measurement allowance tolerance is $\pm 0.1V$. $\pm 0.1V$.
2. Tolerance of measurement of Total radiant flux/ Radiant Intensity: $\approx 10\%$. $\pm 10\%$
3. Care is to be taken that power dissipation does not exceed the absolute maximum rating of the product.
4. All measurements were made under the standardized environment of Refond.
5. When the LEDs are in operation the maximum current should be decided after measuring the package temperature; junction temperature should not exceed the maximum rate. LED
6. ESD yield is over 90% at 2000V ESD (HBM). ESD protection during products handing is needed. 90% LED

ESD2000V

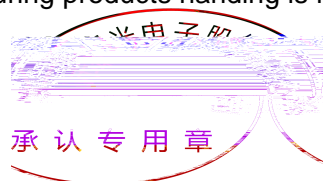

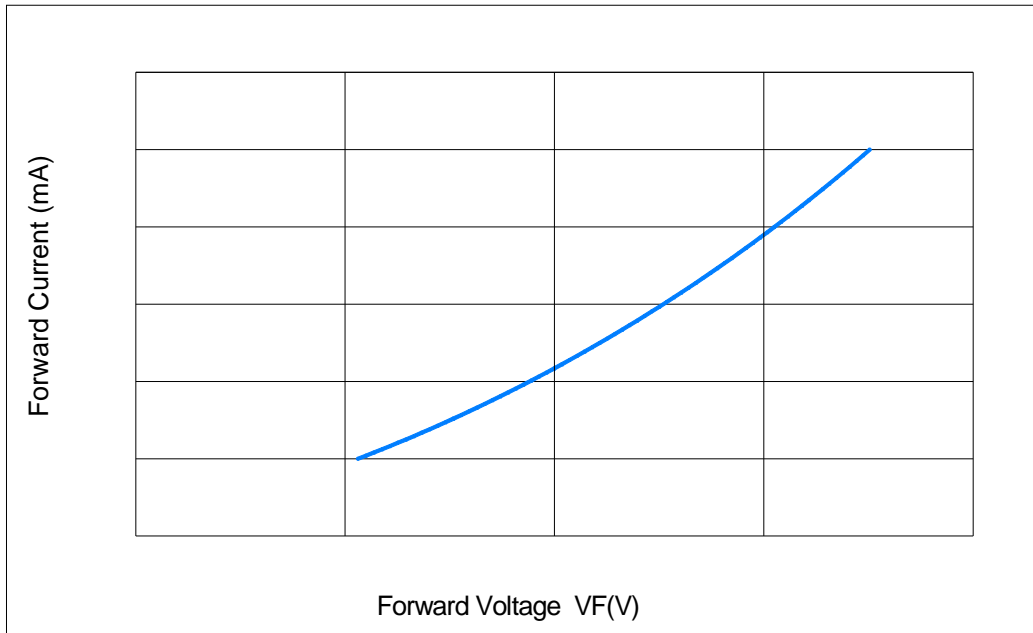

Fig 1-6 Forward Voltage Vs. Forward Current

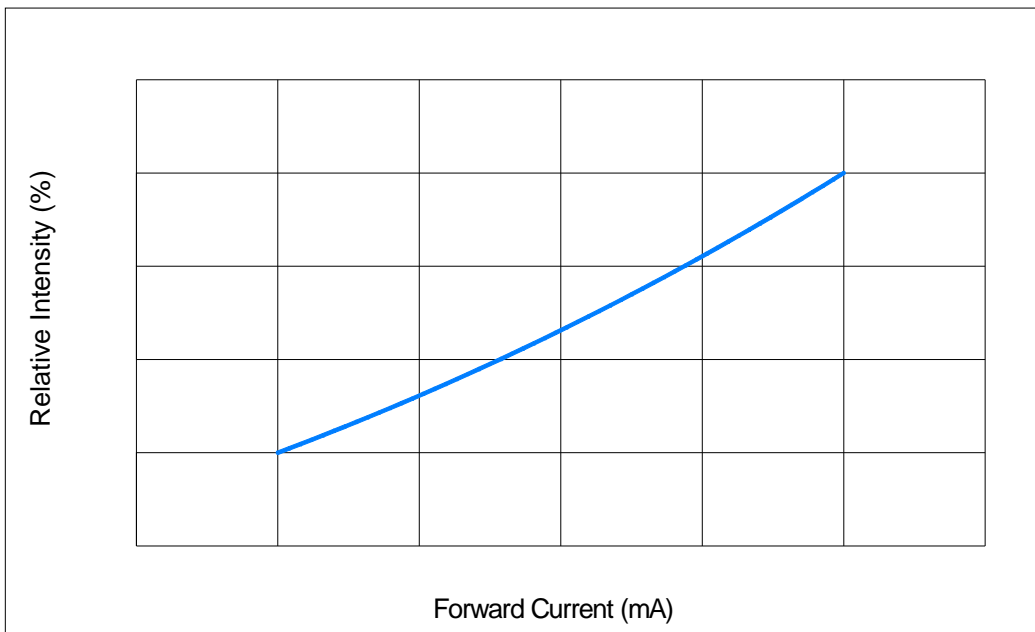

Fig 1-7 Forward Current Vs. Relative Intensity

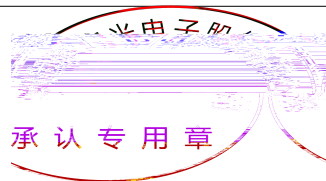

Fig 1-8 Ts Temperature Vs Relative Intensity

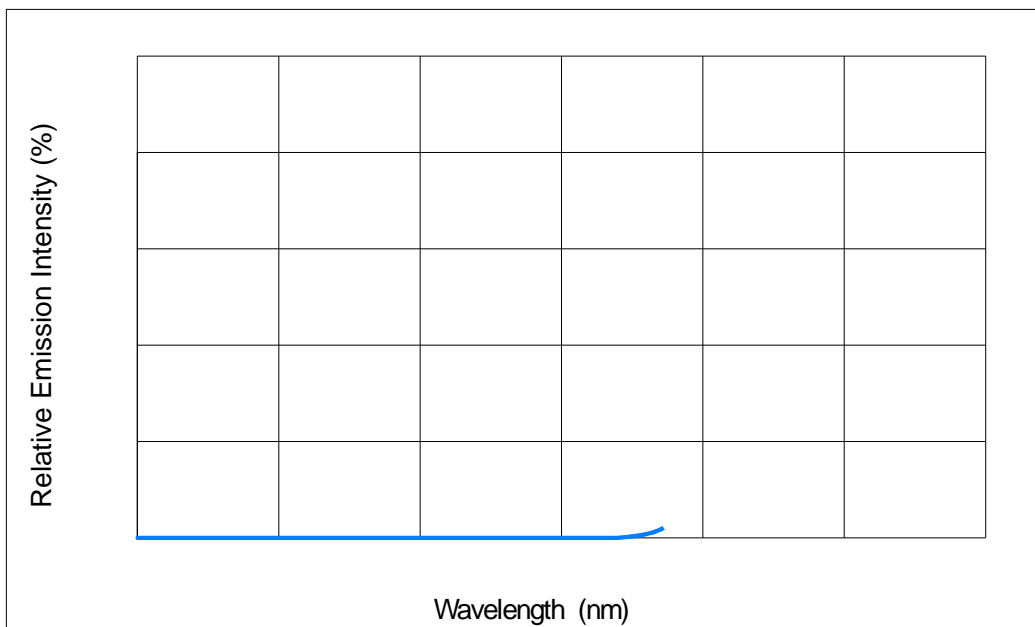

Fig 1-9 Spectrum Distribution

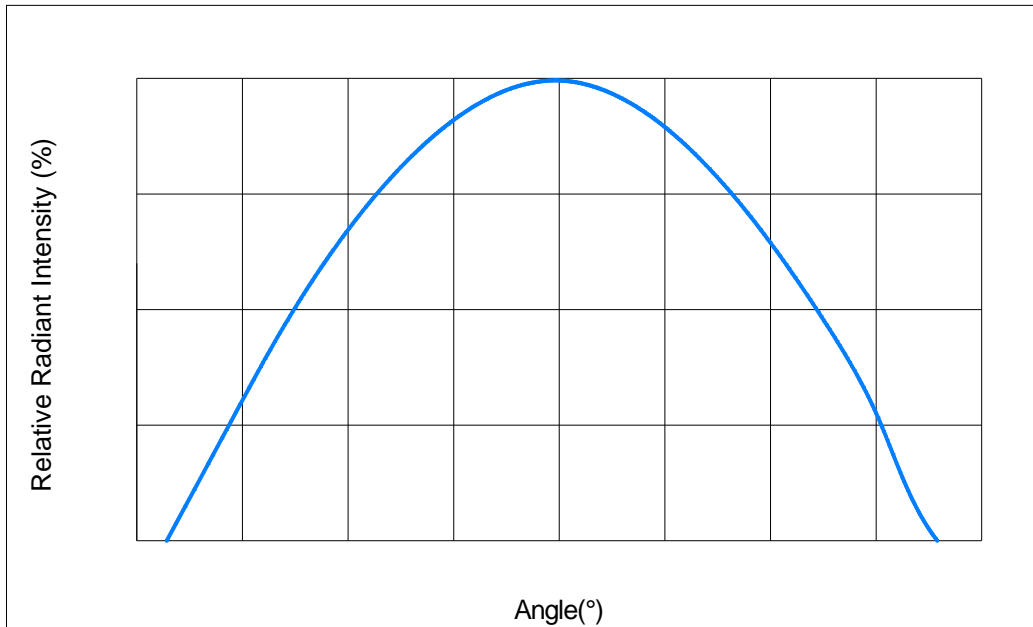

Fig 1-10 Radiation diagram

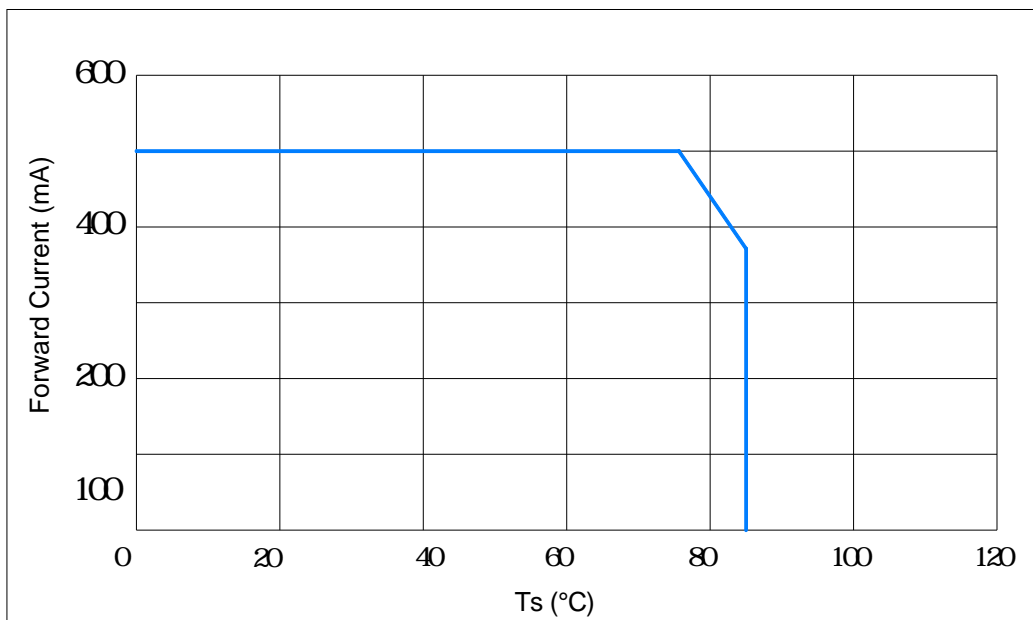
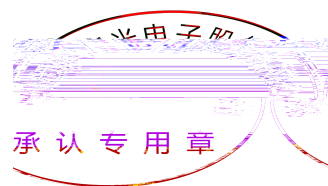

Fig 1-11 Ts Temperature Vs Forward Current



Package:5000pcs/reel. 5000pcs

2.1.1 Carrier Tape Dimension

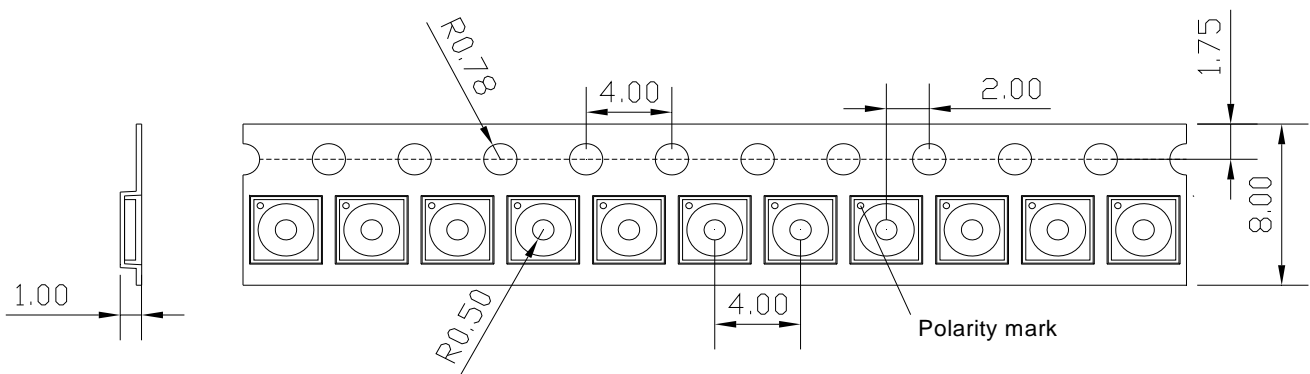

Fig.2-1 Carrier Tape Dimension

2.1.2 Reel Dimension

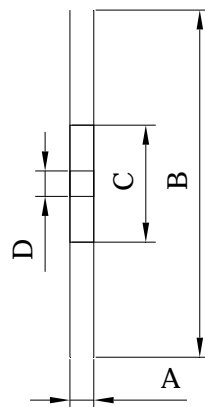
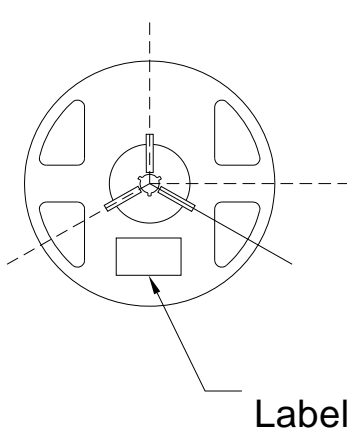

Table 2-1 Dimension

A	8.5 1.0/ 0.2mm
B	178±1mm
C	59±1mm
D	13.3±0.3mm

Fig.2-2Reel Dimension

Notes

The tolerances unless mentioned ±0.1mm. Unit : mm

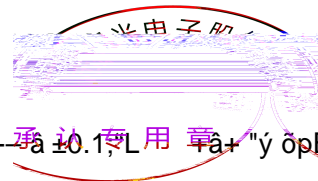

2.1.3 Label Form Specification

Table 2-2 Label Form Specification

PART NO	Part Number
SPEC NO	Spec Number
LOT NO	Lot Number
BIN CODE	Bin Code
e	Total radiant flux
WLP	Peak Wavelength
V _F	Forward Voltage
QTY	Packing Quantity
DATE	Made Date

Fig 2-3 Label Form Specification

2.2 Moisture Resistant Packing

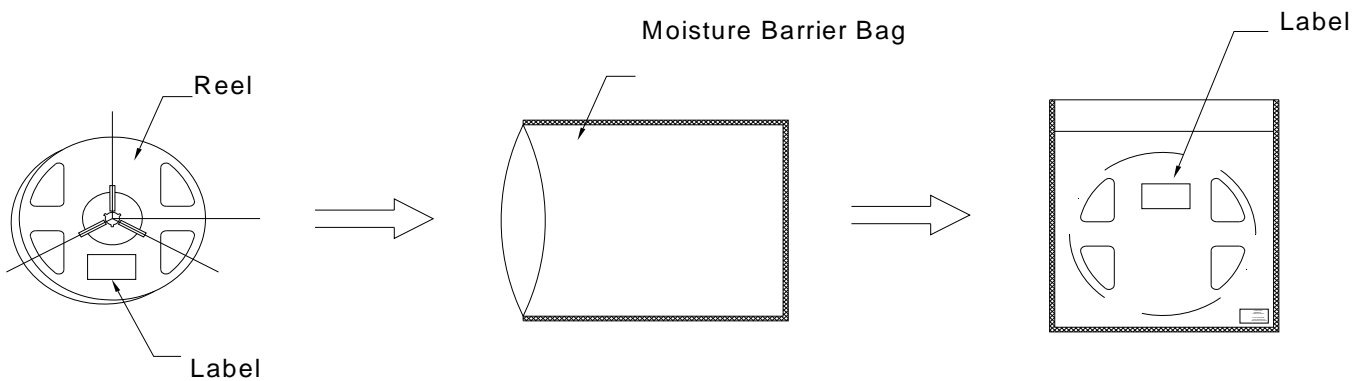

Fig.2-4 Moisture Resistant Packing

2.3 Cardboard Box

4

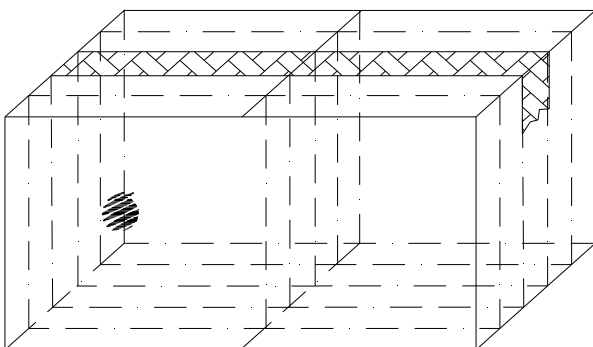

Fig.2-5 Cardboard Box

4

Table 2-3 Reliability Test Items And Conditions

Test Items	Ref.Standard	Test Condition	Time	Quantity	Ac/Re /
Reflow	JESD22-B106	Temp:260 max T=10 sec	3times.	10pcs	0/1
Temperature Cycle	JESD22-A106	100°C 30 min. 5 min -40°C 30 min.	100 cycles	10Pcs.	0/1
Thermal Shock	JESD22-A104	-40 15min 10s 100 15min	300 cycles	10pcs.	0/1
High Temperature Storage	JESD22-A103	Temp:100	1000hrs.	10pcs	0/1
Low Temperature Storage	JESD22-A119	Temp:-40	1000hrs.	10pcs.	0/1
Life Test	JESD22-A108	Ta=25 If=500mA	1000hrs.	10pcs.	0/1

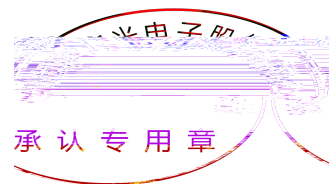
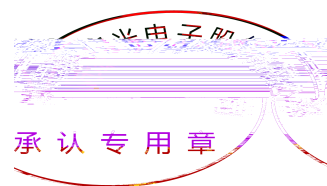

Table Criteria For Judging Damage

Test Items	Symbol	Test Condition	Criteria For Judgement	
			Min.	Max.
Forward Voltage	V_F	$I_F=500\text{mA}$	-	U.S.L*)x1.1
Reverse Current	I_R	$V_R = 5V$	-	U.S.L*)x2.0
Total radiant flux	e	$I_F=500\text{mA}$	L.S.L*)x0.7	-

Notes

- 1.U.S.L: Upper standard level L.S.L: Lower standard level
- 2.The Reliability tests are based on Refond existing test platform.
- 3.The technical information shown in the data sheets are limited to the typical characteristics and circuit examples of the referenced products. It does not constitute the warranting of industrial property nor the granting of any license.



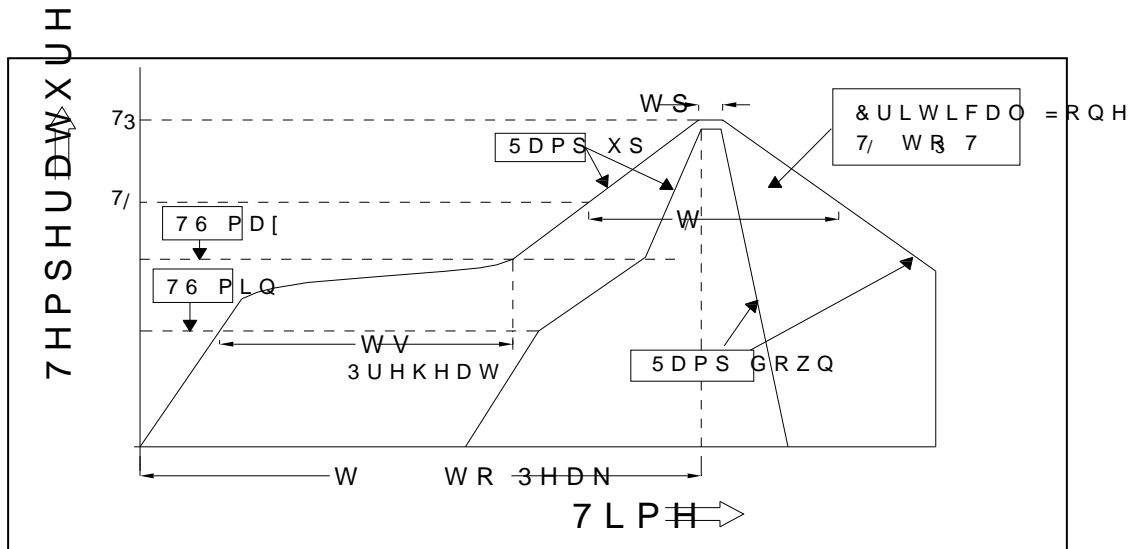
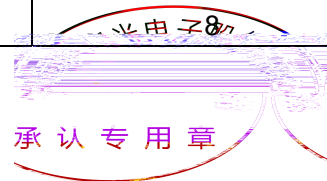

Fig.3-1 SMT Reflow Soldering Instructions SMT

Table 3-1 SMT Reflow Soldering Instructions SMT

Tsmax	TP	3 °C/
(Tsmin)		150 °C
(Tsmax)		200 °C
Tsmin	Tsmax	60 - 120
(TL)		217 °C
(tl)		60
/	(TP)	260 °C
	tp	10
(TP)	5 °C	30
		6 °C/
25 °C		



Notes

(1) Reflow soldering should not be done more than two times. In the case of more than 24 hours passed soldering after first, LEDs will be damaged. 24

LED

(2) When soldering , do not put stress on the LEDs during heating.

3.1.1 Soldering Iron

(1) When hand soldering, keep the temperature of iron below less 300 W less than 3 seconds

300 3

(2) The hand solder should be done only one time.

3.1.2 Repairing

Repair should not be done after the LEDs have been soldered. When repairing is unavoidable, a double-head soldering iron should be used (as below figure). It should be confirmed in advance whether the characteristics of LEDs will or will not be damaged by repairing.

LED

LED

3.1.3 Cautions

(1) The encapsulated material of the LEDs is silicone. Therefore the LEDs have a soft surface on the top of package. The pressure to the top surface will be influence to the reliability of the LEDs. Precautions should be taken to avoid the strong pressure on the encapsulated part. So when use the picking up nozzle, the pressure on the silicone resin should be proper. LED LED

(2) Components should not be mounted on warped (non coplanar) portion of PCB. After soldering, do not warp the circuit board. LED PCB

(3) Do not apply mechanical force or excess vibration during the cooling process to normal temperature after soldering. Do not rapidly cool device after soldering.

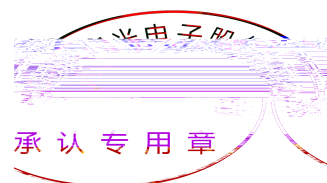

(1) LED operating environment and sulfur element composition cannot be over 100PPM in the LED mating usage material. This is provided for informational purposes only and is not a warranty or endorsement.

LED

100PPM

(2) In order to prevent external material from getting into the inside of LED, which may cause the malfunction of LED, the single content of Bromine element is required to be less than 900PPM, the single content of Chlorine element is required to be less than 900PPM, the total content of Bromine element and Chlorine element in the external materials of the application products is required to be less than 1500PPM. This is provided for informational purposes only and is not a warranty or endorsement.

LED

900PPM

900PPM

1500PPM

(3) VOCs (Volatile organic compounds) emitted from materials used in the construction of fixtures can penetrate silicone encapsulants of LEDs and discolor when exposed to heat and photonic energy. The result can be a significant loss of light output from the fixture. Knowledge of the properties of the materials selected to be used in the construction of fixtures can help prevent these issues. Refond advises against the use of any chemicals or materials that have been found or are suspected to have an adverse affect on device performance or reliability. To verify compatibility, Refond recommends that all chemicals and materials be tested in the specific application and environment for which they are intended to be used. Attaching LEDs, do not use adhesives that outgas organic vapor.

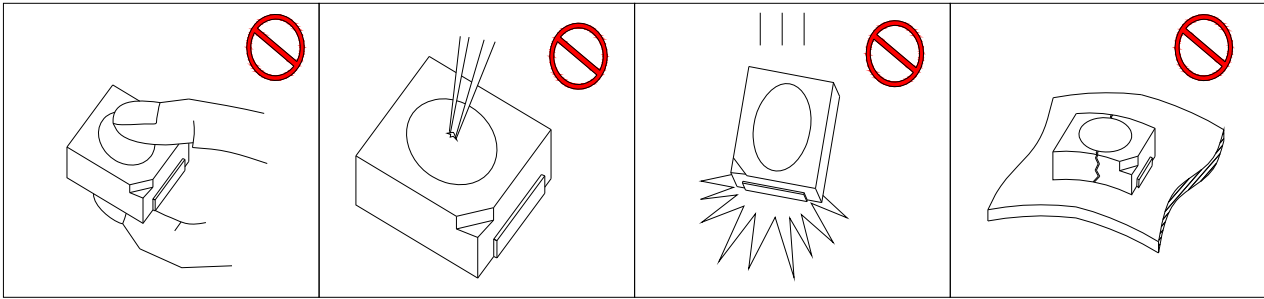

Fig 4-1

(5) In designing a circuit, the current through each LED must not exceed the absolute maximum rating specified for each LED. In the meanwhile, resistors for protection should be applied, otherwise slight voltage shift will cause big current change, burn out may happen. The driving circuit must be designed to allow forward voltage only when it is ON or OFF. If the reverse voltage is applied to LED, migration can be generated resulting in LED damage.

LED

LED

(6) Thermal Design is paramount importance because heat generation may result in the Characteristics decline, such as brightness decreased, Color change and so on. Please consider the heat generation of the LEDs when making the system design.

LED

(7) Compared to standard encapsulants, silicone is generally softer, and the surface is more likely to attract dust requiring special care during processing. In cases where a minimal level of dirt and dust particles cannot be guaranteed, a suitable cleaning solution must be applied to the surface after the soldering of components. Refond suggests using isopropyl alcohol for cleaning. In case other solvents are used, it must be assured that these solvents do not dissolve the package or resin. Ultrasonic cleaning is not recommended. Ultrasonic cleaning may cause damage to the LED.

LED

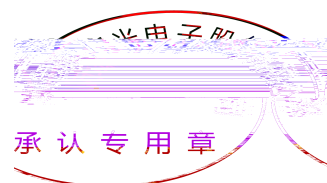



Declare

This specification is written both in English and in Chinese and the latter is formal.

