

# SPECIFICATION

REFOND P/N

RF-GNRB14TS-CF

R&D

Mass Production



## Contents

1. Description	3
1.1 General Description	3
1.2 Features	3
1.3 Application	3
1.4 Package Dimension	4
1.5 Product Parameters	5
1.6 Bin Range Of Forward Voltage and Luminous Intensity and Dominant wavelength (IF=20mA)	
BIN (IF=20mA)	6
1.7 Typical Optical Characteristics Curves	7
2. Packaging	11
2.1 Packaging Specification	11
2.1.1 Carrier Tape Dimension	11
2.1.2 Reel Dimension	11
2.1.3 Label Form Specification	12
2.2 Moisture Resistant Packing	12
2.3 Cardboard Box	12
2.4 Reliability Test Items And Conditions	13
2.5 Criteria For Judging Damage	14
3. SMT Reflow Soldering Instructions SMT	15
3.1 SMT Reflow Soldering Instructions SMT	15
4. Handling Precautions	17
4.1 Handling Precautions	17



# 1. Description

## 1.1 General Description



The Green source color devices are made with GaN Substrate Light Emitting Diode  
 Product Package: 2.2mmX1.4mmX1.3mm.

LED GaN

2.2mmX1.4mmX1.3mm

## 1.2 Features

- ▶ PLCC2 Package. PLCC2
- ▶ Extremely wide viewing angle.
- ▶ Suitable for all SMT assembly and solder process. SMT
- ▶ Available on tape and reel.
- ▶ Moisture sensitivity level: Level 2. Level2
- ▶ Compliance with RoHS and REACH. RoHS REACH
- ▶ Qualifications: The product qualification test plan is based on the guidelines of AEC-Q101  
 Stress Test Qualification for Automotive Grade Discrete Semiconductors  
 AEC-Q101

## 1.3 Application

- ▶ Automotive Lighting Interior.



## 1.4 Package Dimension



### Notes

1. All dimensions units are millimeters.
2. All dimensions tolerances are  $\pm 0.20\text{mm}$  unless otherwise noted.



## 1.5 Product Parameters

Table 1-1 Electrical / Optical Characteristics at Ts=25°C

Item	Symbol	Test Condition	Value			Unit
			Min.	Typ.	Max.	
Forward Voltage	$V_F$	$I_F=20\text{mA}$	2.8	3.0	3.4	V
Reverse Current	$I_R$	$V_R=5\text{V}$	---	---	10	$\mu\text{A}$
Luminous Intensity	$I_V$	$I_F=20\text{mA}$	800	1200	1500	mcd
Dominant wavelength	WD	$I_F=20\text{mA}$	515	520	525	nm
Viewing Angle	$2\theta_{1/2}$	$I_F=20\text{mA}$	---	120	---	deg

Thermal Resistance.

Table 1-2 Absolute Maximum Ratings at Ts=25°C

## Notes

1. 1/10 Duty cycle, 10ms pulse width.      10ms,      1/10.
2. The above forward voltage measurement allowance tolerance is  $\pm 0.1V$ .       $\pm 0.1V$ .
3. The above color coordinates measurement allowance tolerance is  $\pm 0.005$ .       $\pm 0.005$ .
4. The above luminous intensity measurement allowance tolerance  $\pm 10\%$ .       $\pm 10\%$ .
5. Care is to be taken that power dissipation does not exceed the absolute maximum rating of the product.
6. All measurements were made under the standardized environment of Refond.
7. When the LEDs are in operation the maximum current should be decided after measuring the package temperature, junction temperature should not exceed the maximum rate. LED
8. ESD yield is over 90% at 2000V ESD (HBM). ESD protection during products handling is needed. 90% LED ESD2000V

### 1.6Bin Range Of Forward Voltage and Luminous Intensity and Dominant wavelength (IF=20mA)      BIN      (IF=20mA)

Table 1-3

V <sub>F</sub>	G1	G2	H1	H2	I1	I2
	2.8-2.9	2.9-3.0	3.0-3.1	3.1-3.2	3.2-3.3	3.3-3.4
IV mcd	L1	L2	M1			
	800-1000	1000-1200	1200-1500			
WD(nm)	D1	D2	E1	E2		
	515-517.5	517.5-520	520-522.5	525.5-525		





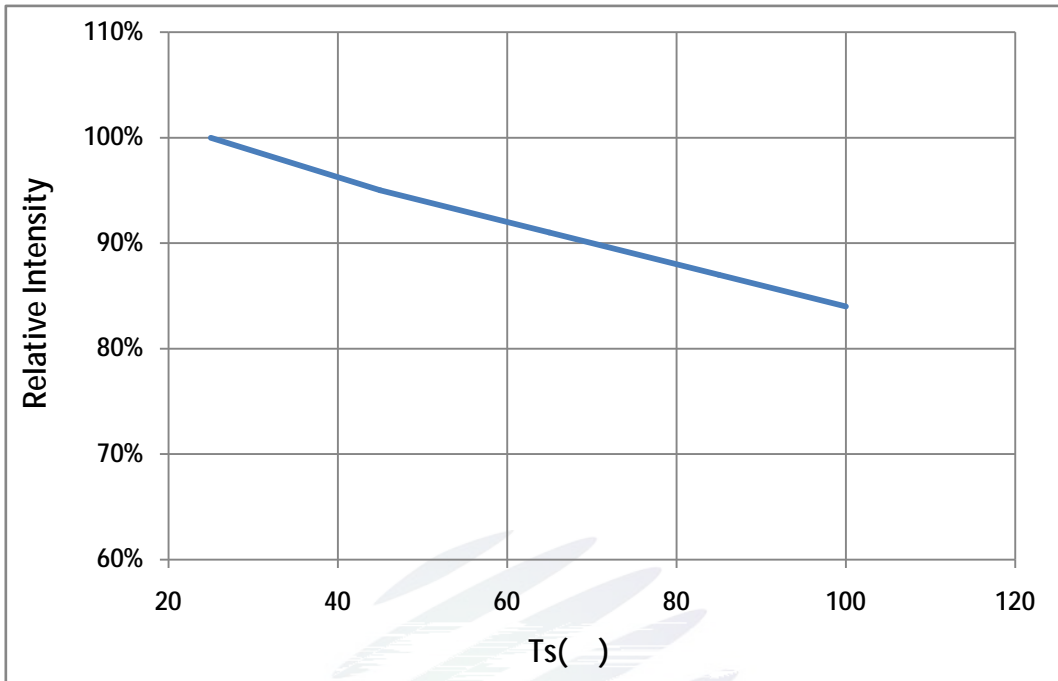

Fig. 1-8 Solder Temperature Vs Relative Intensity

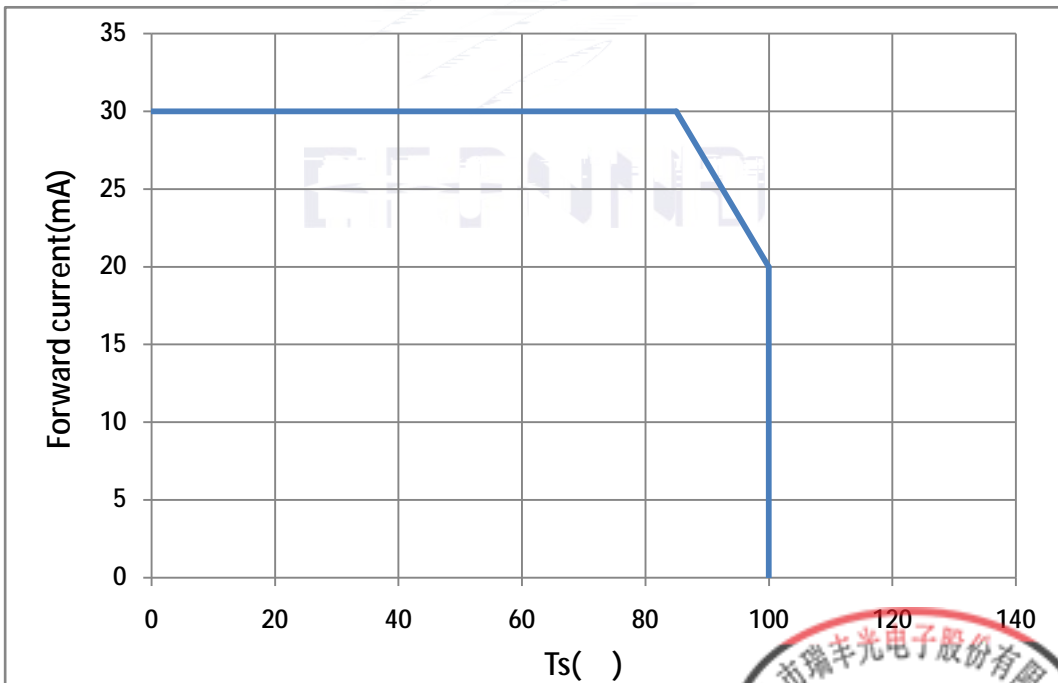
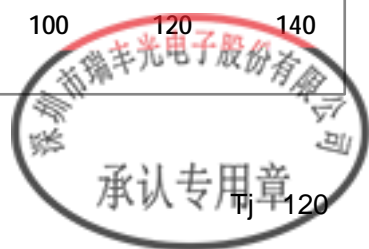

Fig. 1-9 Solder Temperature Vs Forward Current





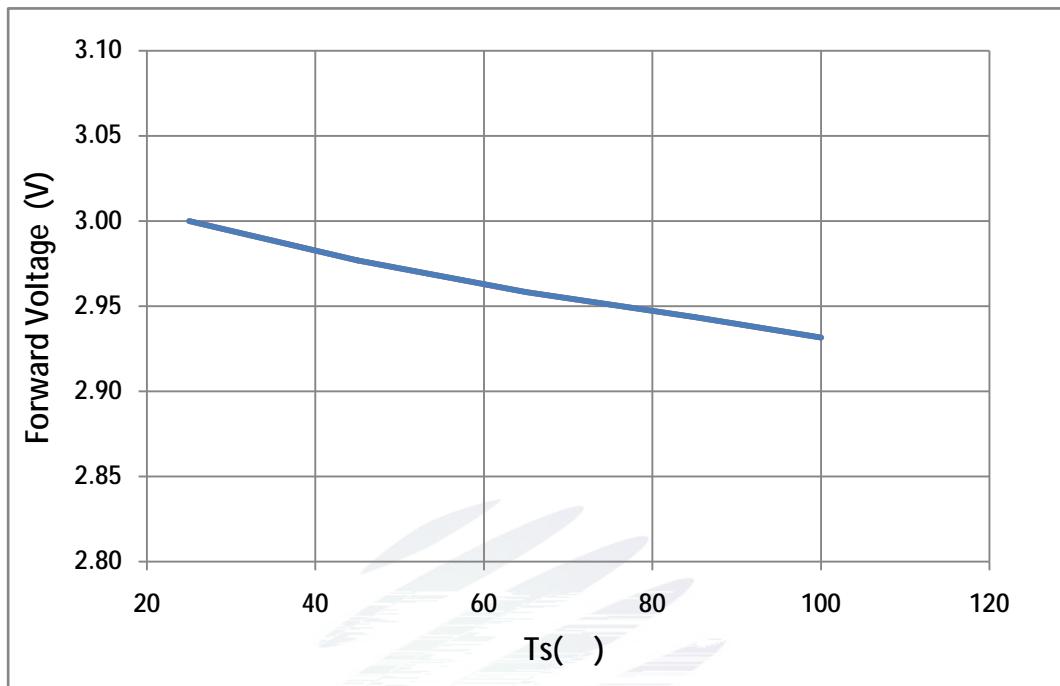

Fig. 1-10 Forward Voltage Vs Solder Temperature

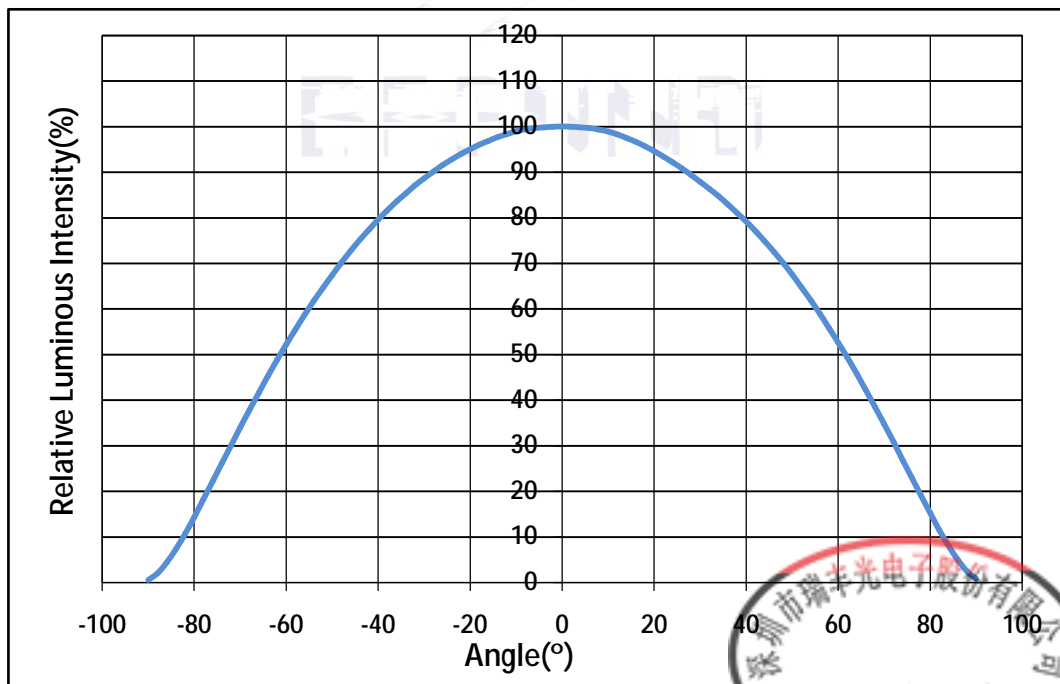
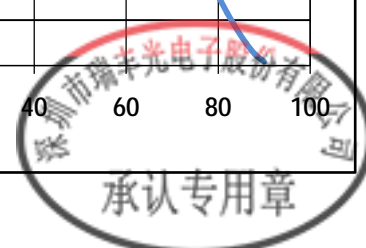

Fig. 1-11 Radiation diagram



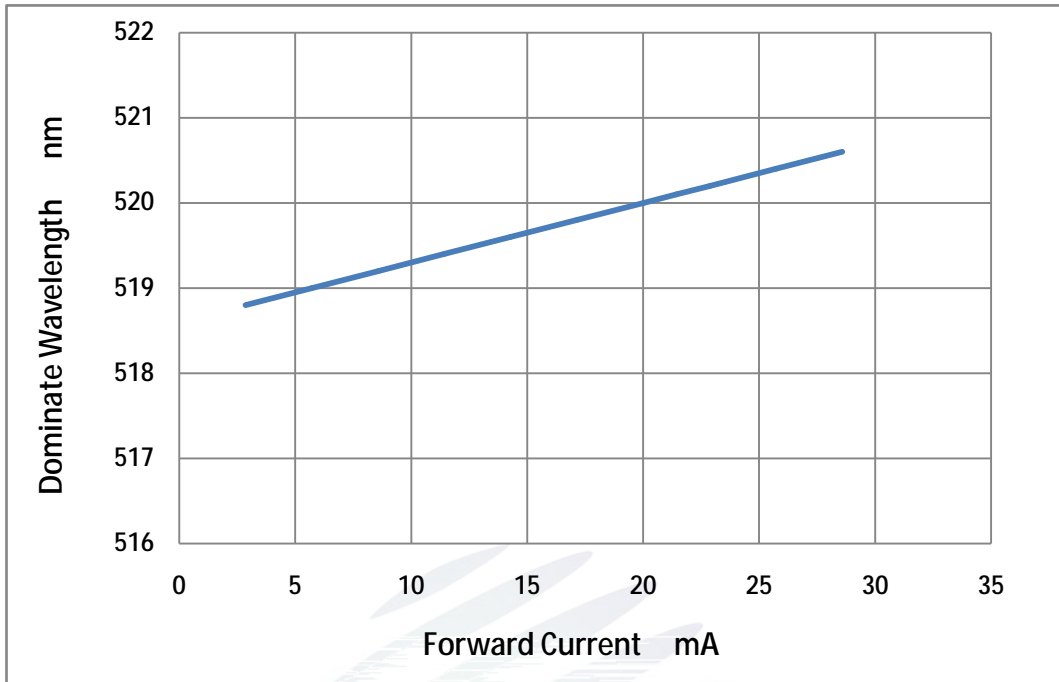

Fig. 1-12 Forward current VS Dominate wavelength (Ts=25°C)

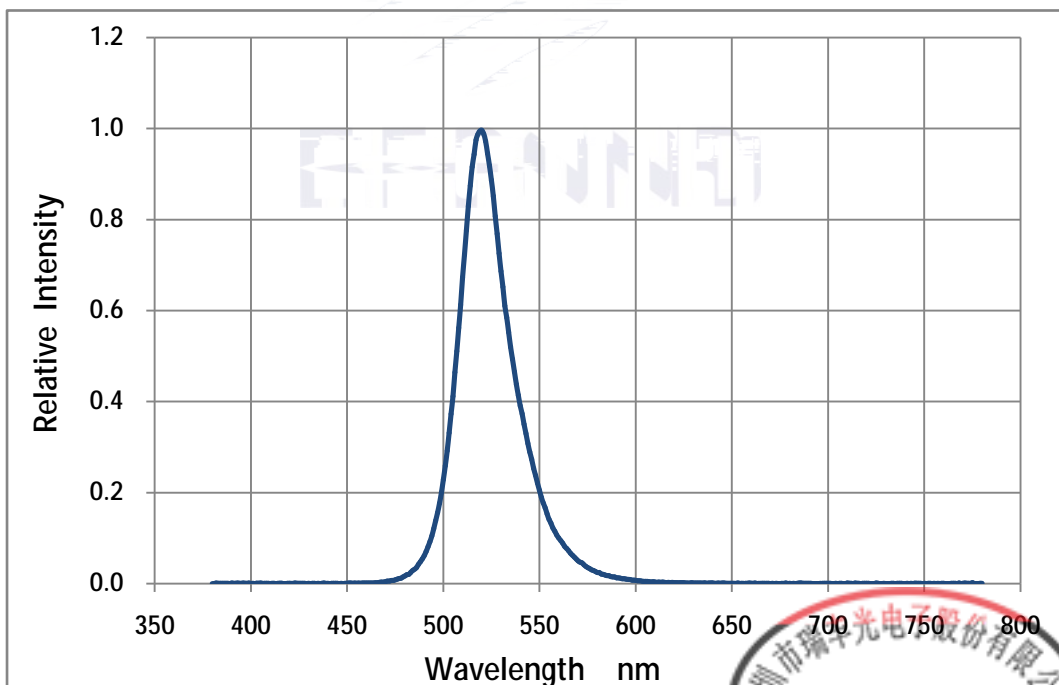
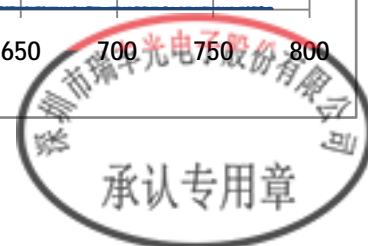

Fig. 1-13 Spectrum Distribution



## 2. Packaging

### 2.1 Packaging Specification

Package:3000pcs/reel. 3000pcs

#### 2.1.1 Carrier Tape Dimension



Fig.2-1 Carrier Tape Dimension

#### 2.1.2 Reel Dimension

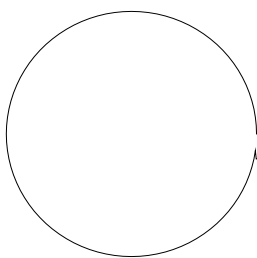

Table 2-1 Reel Dimension

A	8.0± 0.1mm
B	178.0± 1.0mm
C	60.0± 1.0mm
D	13.0± 0.5mm

Fig.2-2 Reel Dimension

#### Notes

The tolerances unless mentioned  $\pm 0.1$ mm. Unit : mm  $\pm 0.1$

### 2.1.3 Label Form Specification

Table 2-2 Specification

PART NO.	Part Number
SPEC NO.	Spec Number
LOT NO.	Lot Number
BIN CODE	Bin Code
IV	Luminous Intensity
XY	Chromaticity Bin
V <sub>F</sub>	Forward Voltage
WLD	Wavelength
QTY	Packing Quantity
DATE	Made Date

Fig. 2-3 Label Form Specification

### 2.2 Moisture Resistant Packing

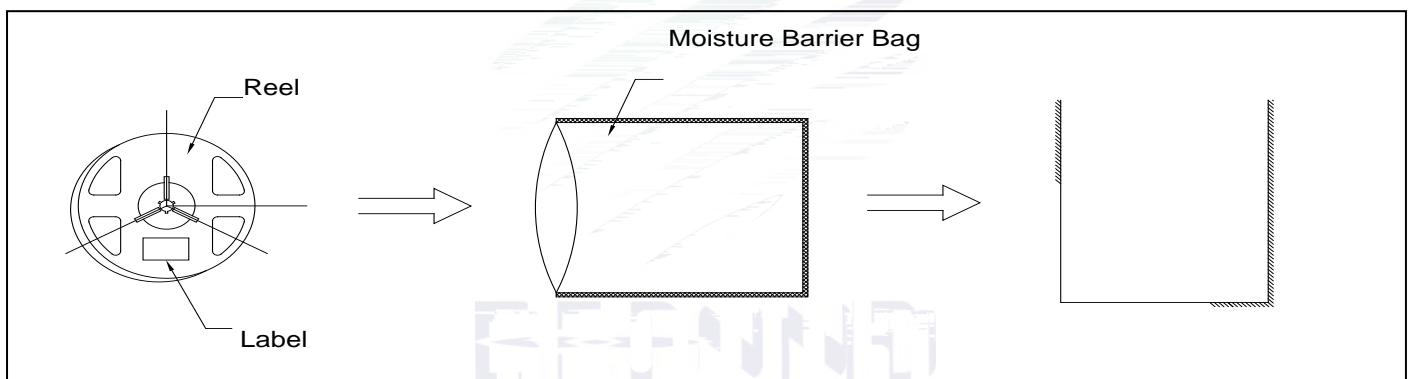

Fig.2-4 Moisture Resistant Packing

### 2.3 Cardboard Box

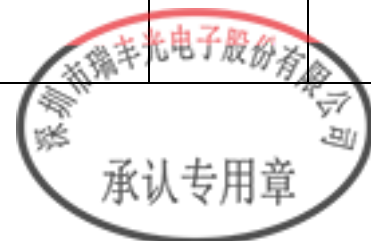

Fig.2-5 Cardboard Box

## 2.4 Reliability Test Items And Conditions

Table 2-3 Reliability Test Items And Conditions

Test Items	Ref. Standard	Test Condition	Time	Quantity	Ac/Re /
Reflow	JESD22-B106	Temp:260 max T=10 sec	2times	20pcs.	0/1
MSL2 2	JESD22-A113	85 / 60%RH	168 hrs.	20pcs.	0/1
Thermal Shock	JEITAED-4701 300307	-40 15min ↑↓10s 125 15min	1000 cycle	20pcs.	0/1
Life Test	JESD22-A108	Ta=105 I <sub>F</sub> =20mA	1000hrs.	20pcs.	0/1
High Temperature High Humidity Life Test	JESD22-A101	85 / 85%RH I <sub>F</sub> =20mA	1000hrs.	20pcs.	0/1



## 2.5 Criteria For Judging Damage

Table 2-4 Criteria For Judging Damage

Test Items	Symbol	Test Condition	Criteria For Judgement	
			Min.	Max.
Forward Voltage	$V_F$	$I_F=20\text{mA}$	-	U.S.L*)x1.1
Reverse Current	$I_R$	$V_R = 5\text{V}$	-	U.S.L*)x2.0
Luminous Intensity	$I_V$	$I_F=20\text{mA}$	L.S.L*)x0.7	-

### Notes

- 1.U.S.L: Upper standard level                      L.S.L: Lower standard level
- 2.The above reliability tests is based on the verification of a single/strip LED of Refond's existing experimental Platform, the reliability experiment was taken under good heat dissipation conditions. When customers applies The LED to the series and parallel circuit, should take consideration of all the factors such as the current, Voltage distribution, heat dissipation and others. / LED  
LED
- 3.The technical information shown in the data sheets is limited to the typical characteristics and circuit examples of the referenced products. It does not constitute the warranting of industrial property nor the granting of any license.



### 3.SMTReflow Soldering Instructions SMT

#### 3.1SMT Reflow Soldering Instructions SMT

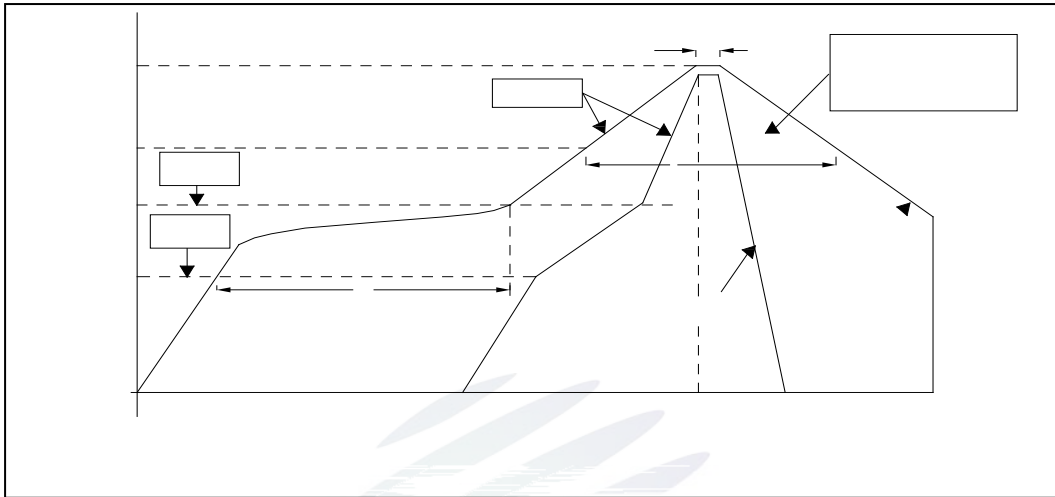

Fig.3-1SMT Reflow Soldering Instructions SMT

Table 3-1Reflow parameters

Average temperature rise speed	$T_{smax} - T_P$	3 °C/ s	Max 3 °C/ s
Preheating: minimum temperature	( $T_{smin}$ )	150 °C	
Preheating: Max temperature	( $T_{smax}$ )	200 °C	
Preheating: Time	$T_{smin} - T_{smax}$	60 - 120	60s-120s
Time limited to maintain high temperature: the temperature	( $T_L$ )	217 °C	
Time limited to maintain high temperature: The Time	( $t_L$ )	60	Max 60s
Peak /Classification of temperature:	( $T_P$ )	260 °C	
Time limit classification of peak temperature time	$t_p$	10	Max 10s
( $T_P$ ) 5 °C	Hold time within 5 °C with the actual peak temperature (TP)	30	Max 30s
Cooling speed		6 °C/ s	Max 6 °C/ s
25 °C	Needed time from 25 °C to $T_P$	8	Max 8 minutes

Notes

(1)Reflow soldering should not be done more than twice. If more than 24 hours between the two soldering,LED will be damaged. 24 LED

(2)When soldering , do not put stress on the LEDs during heating.

3.1.1 Soldering Iron

(1) When do soldering by hand, keep the temperature of iron below less 300 less than 3 seconds  
, 300 3

(2) Soldering by hand should be done only one time.

3.1.2 Repairing

Repairing should not be done after the LEDs have been soldered. When repairing is unavoidable, a double-head soldering iron should be used (as below figure). It should be confirmed in advance whether the characteristics of LEDs will or not be damaged by repairing.

LED

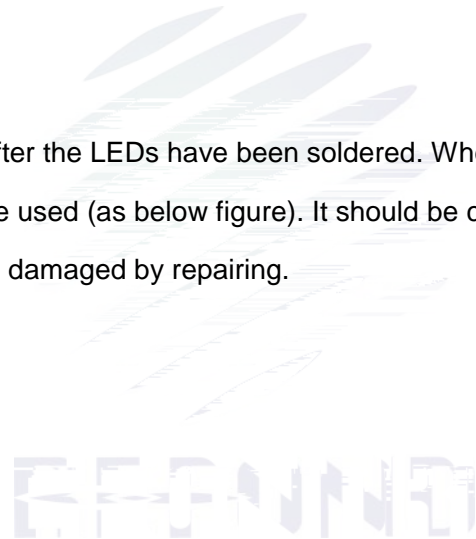



## 4. Handling Precautions

### 4.1 Handling Precautions

(1) LED operating environment and sulfur element composition cannot be over 100PPM in the LED mating usage material. This is provided for informational purposes only and is not a warranty or endorsement.

LED 100PPM

(2) In order to prevent ex-ternal material from getting into the inside of LED, which may cause the malfunction of LED, the single content of Bromine element is required to be less than 900PPM,the single content of Chlorine element is required to be less than 900PPM,the total content of Bromine element and Chlorine element in the external materials of the application products is required to be less than 1500PPM. This is provided for informational purposes only and is not a warranty or endorsement.

LED 900PPM 900PPM 1500PPM LED

(3) VOCs (Volatile organic compounds) emitted from materials used in the construction of fixtures can penetrate silicone encapsulants of LEDs and discolor when exposed to heat and photonic energy. The result can be a significant loss of light output from the fixture. Knowledge of the properties of the materials selected to be used in the construction of fixtures can help prevent these issues. Refond advises against the use of any chemicals or materials that have been found or are suspected to have an adverse affect on device performance or reliability. To verify compatibility, Refond recommends that all chemicals and materials be tested in the specific application and environment for which they are intended to be used. Attaching LEDs, do not use adhesives that outgas organic vapor.

LED LED LED

LED

(4) Handle the component along the side surface by using forceps or appropriate tools. Do not directly touch or Handle the silicone lens surface, it may damage the internal circuitry.



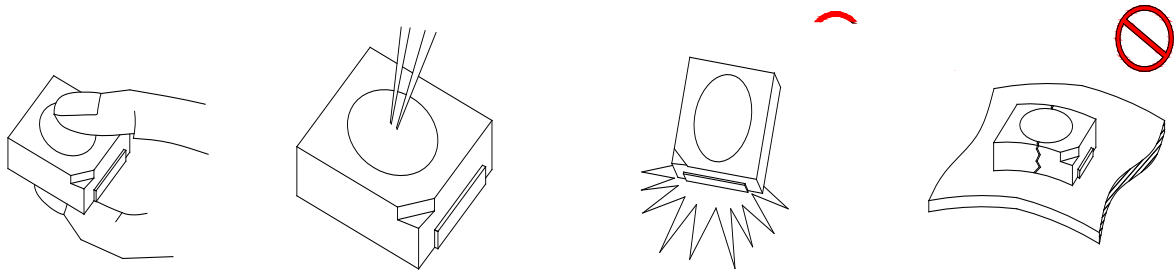

Fig 4-1 Handling Precautions

(5) In designing a circuit, the current through each LED can not exceed the absolute maximum rating specified for each LED. In the meanwhile, resistors for protection should be applied, otherwise slight voltage shift will cause big current change, burn out may happen. The driving circuit must be designed to allow forward voltage only when it is ON or OFF. If the reverse voltage is applied to LED, migration can be generated resulting in LED damage.

LED

LED

(6) Thermal Design is paramount importance because heat generation may result in the Characteristics decline, such as brightness decreased, Color change and so on. Please consider the heat generation of the LEDs when making the system design.

LED

LED

(7) Compared to standard encapsulants, silicone is generally softer, and the surface is more likely to attract dust, requiring special care during processing. In cases where a minimal level of dirt and dust particles cannot be guaranteed, a suitable cleaning solution must be applied to the surface after the soldering of components. Refond suggests using isopropyl alcohol for cleaning. In case other solvents are used, it must be assured that these solvents do not dissolve the package or resin. Ultrasonic cleaning is not recommended. Ultrasonic cleaning may cause damage to the LED.

LED









www.refond.com



Declare

This specification is written both in English and in Chinese and the latter is formal.