

# SPECIFICATION

REFOND P/N

RF-A3H20-2W2F-E2

D&D

Mass Production

## Contents

### 1. Description

#### 1.1 General Description

#### 1.2 Features

#### 1.3 Application

#### 1.4 Package Dimension

#### 1.5 Product Parameters

#### 1.6 Bin Range Of Forward Voltage and Luminous Flux (IF=200mA)

BIN

(IF=200mA)

The Chromaticity .....0TJ 6CEsg(o)r 6CEsm7... '54€CP5B )• , •ÕÀ( Òv ì-0Thkh(o)e6CEs Ch6

REFOND

## 1. Description

### 1.1 General Description

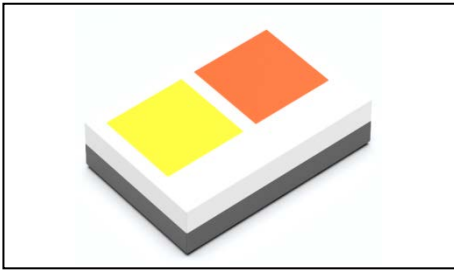

This product uses the ceramics package, it has a high reliability. it also be widely application for Automotive Exterior Lighting. Size(mm):2.0X1.6X0.8mm.

2.0X1.6X0.8mm

### 1.2 Features

Ceramic Package.

High Power Output and High Luminance.

Pb-free reflow soldering application.

Moisture sensitive level:Level2. Level 2

Compliance with RoHS and REACH. Da: E DEAC:

Qualifications: The product qualification test plan is based on the guidelines of AEC-Q102  
Stress Test Qualification for Automotive Grade Discrete Semiconductors  
AEC-C102

### 1.3 Application

Automotive Exterior Lighting, Daytime Running Lamp, Headlamp, Fog lamp.

## 1.4 Package Dimension

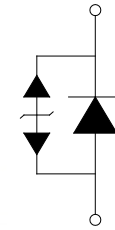
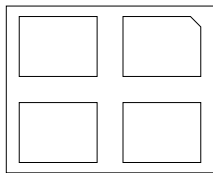
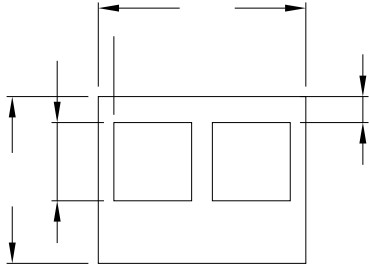

### Notes

1. All dimensions units are millimeters.
2. All dimensions tolerances are  $\pm 0.2\text{mm}$  unless otherwise noted.

*f* 0.2

## 1.5 Product Parameters

Table 1-1 Electrical / Optical Characteristics at Ts=25°C

Item	Symbol	Test Condition	White			Unit
			Min.	Typ	Max.	
Forward Voltage	$V_F$	$I_F=200mA$	2.8	---	3.4	V
Reverse Current	$I_R$	$V_R=5V$	---	---	10	$\mu A$
luminous flux ( )		$I_F=200mA$	75	---	120	lm
Viewing Angle	2 1/2	$I_F=200mA$	---	120	---	deg
Color Rendering Index ( )	$R_a$	$I_F=200mA$	---	---	---	---
Thermal Resistance.	$R_{THJ-S}$	$I_F=200mA$	---	---	8.2	$\backslash W$

Item	Symbol	Test Condition	Amber			Unit
			Min.	Typ	Max.	
Forward Voltage	$V_F$	$I_F=200mA$	2.8	---	3.4	V
Reverse Current	$I_R$	$V_R=5V$	---	---	10	$\mu A$
luminous flux ( )		$I_F=200mA$	50	---	90	lm
Viewing Angle	2 1/2	$I_F=200mA$	---	120	---	deg
Color Rendering Index ( )	$R_a$	$I_F=200mA$	---	---	---	---
Thermal Resistance.	$R_{THJ-S}$	$I_F=200mA$	---	---	9	$\backslash W$

Table 1-2 Absolute Maximum Ratings at Ts=25°C

Parameter	Symbol	Rating	Units
Power Dissipation	$P_D$	2520	W
Forward Current	$I_F$	350	mA
Peak Forward Current	IFP	500	mA
Reverse Voltage	$V_R$	5	V
Electrostatic Discharge (HBM)	$E_{SD}$	8000	V
Operating Temperature	$T_{OPR}$	-40 ~ +125	
Storage Temperature	$T_{OPR}$	-40 ~ +125	
Junction Temperature	$T_J$	150	

Notes

- 1/10 Duty cycle, 0.1ms pulse width. 0.1ms, 1/10.
- The above forward voltage measurement allowance tolerance is  $\pm 0.1V$ .  $\pm 0.1V$ .
- The above color coordinates measurement allowance tolerance is 0.005.  $f$  0.005.
- The above luminous flux measurement allowance tolerance  $\pm 10\%$ .  $\pm 10\%$ .
- Care is to be taken that power dissipation does not exceed the absolute maximum rating of the product.
- All measurements were made under the standardized environment of Refond.
- When the LEDs are in operation the maximum current should be decided after measuring the package temperature junction temperature should not exceed the maximum rate.  $>ED$
- ESD yield is over 90% at 8000V ESD (HBM). ESD protection during products handing is needed. 90%  $>ED$   
EED8000H

## 1.6 Bin Range Of Forward Voltage and Luminous Flux (IF=200mA)

**BIN (IF=200mA)**

Table 1-3

$V_F$		G0	H0	I0
		2.8-3.0	3.0-3.2	3.2-3.4
(lm)	White	AB	AC	AD
		75-90	90-105	105-120
	Amber	FI	AA	AB
		50-60	60-75	75-90

### The Chromaticity Diagram

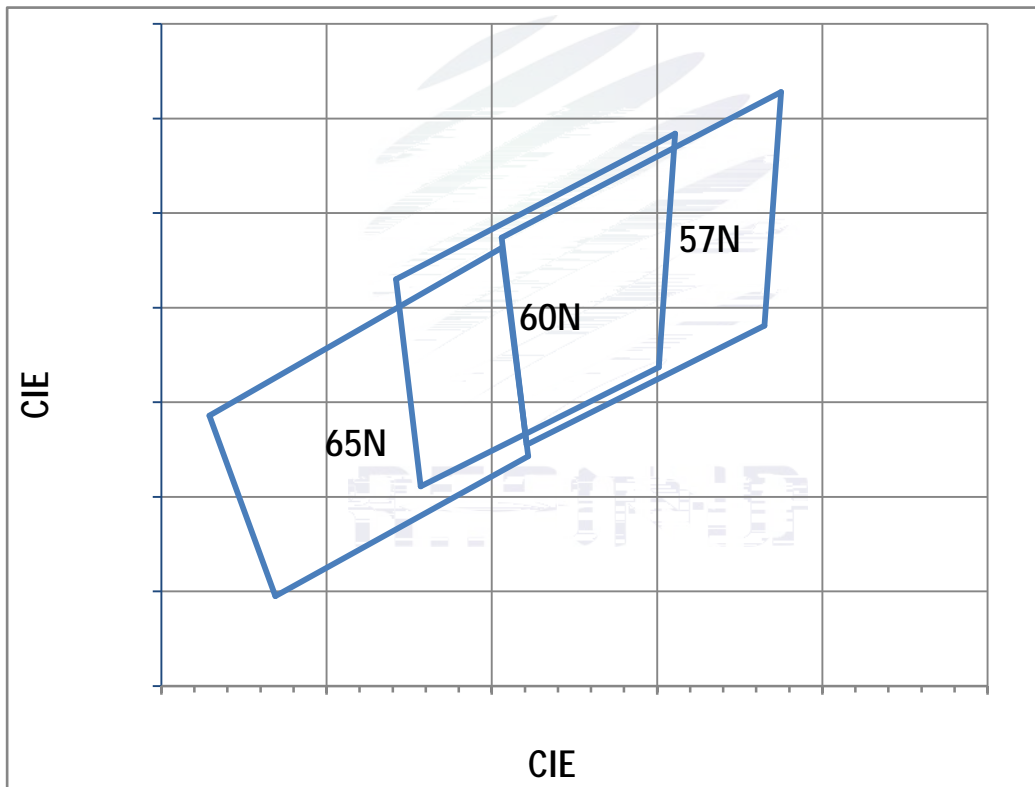

### Bin data

BIN CODE	X1	Y1	X2	Y2	X3	Y3	X4	Y4
57N	0.3221	0.3255	0.3206	0.3474	0.3375	0.3628	0.3365	0.3381
60N	0.3157	0.3211	0.3142	0.3430	0.3311	0.3584	0.3301	0.3337
65N	0.3029	0.3286	0.3206	0.3463	0.3222	0.3243	0.3069	0.3095





## 1.7 Typical optical characteristics curves



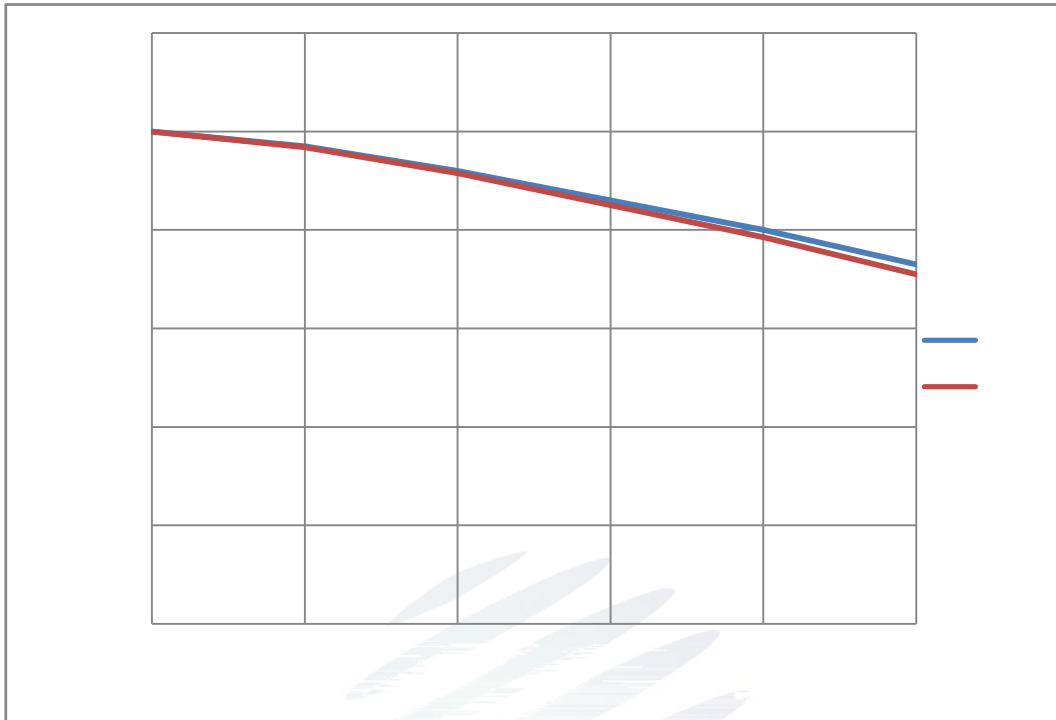

Fig 1-8 Ts Temperature Vs Relative Intensity

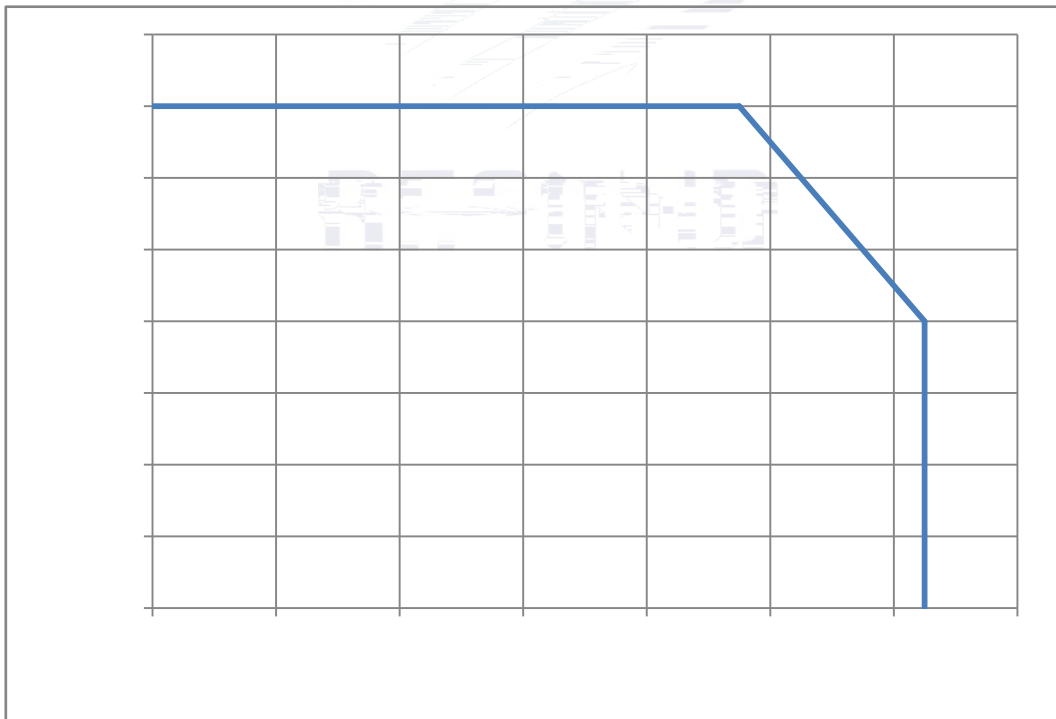

Fig 1-9 Ts Temperature Vs Forward Current

Tj 150

Fig. 1-10 Forward Voltage Vs Solder Temperature

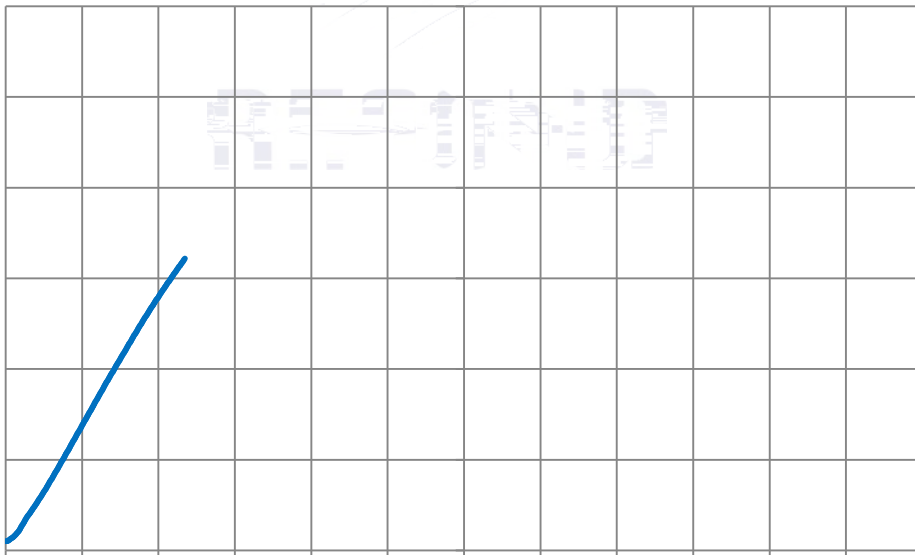

Fig 1-11 Radiation diagram

Fig. 1-12 Chromaticity Coordinate Vs Solder Temperature

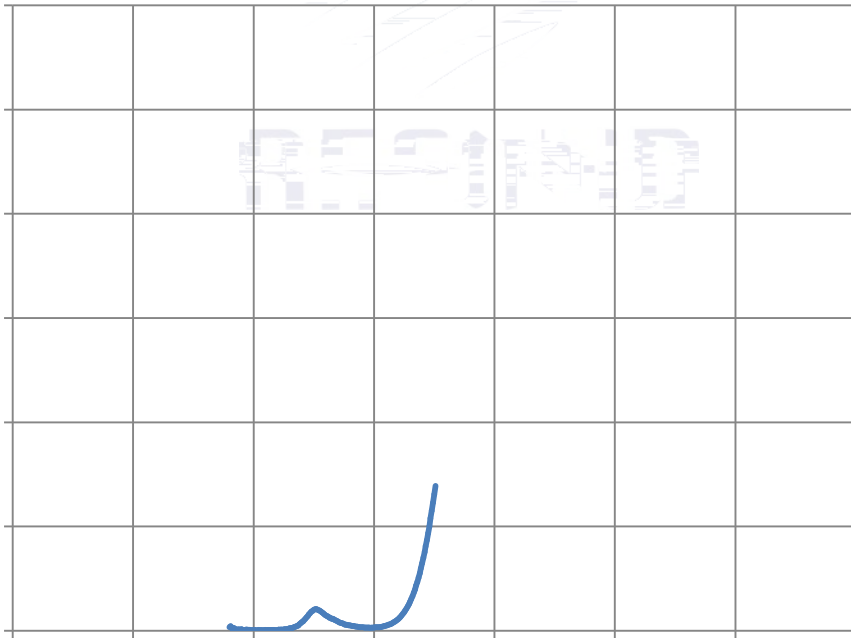

Fig 1-13 Spectrum Distribution

## 2. Packaging

### 2.1 Packaging Specification

Package: 4000pcs/reel.      4000bUe

#### 2.1.1 Carrier Tape Dimension

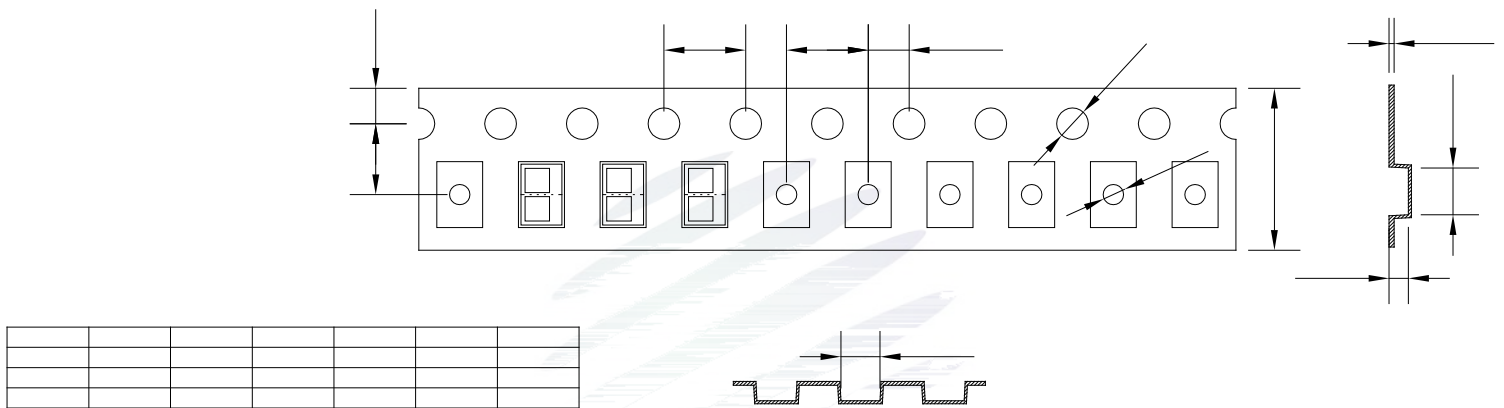

Fig.2-1 Carrier Tape Dimension

#### 2.1.2 Reel Dimension

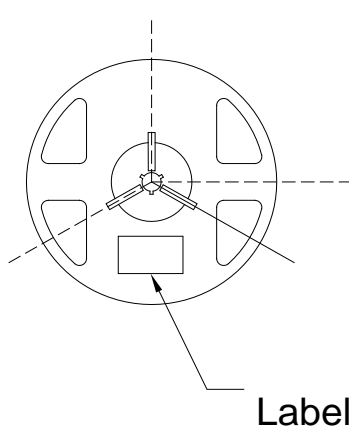

Fig.2-2 Reel Dimension

Table 2-1 Dimension

A	12 0.3mm
B	180±2mm
C	60.0±1mm
D	13.0±0.2mm

#### Notes

The tolerances unless mentioned  $\pm 0.1$ mm. Unit : mm       $\pm 0.1$

### 2.1.3 Label Form Specification

Table 2-2 Label Form Specification

PART NO	Part Number
SPEC NO	Spec Number
LOT NO	Lot Number
BIN CODE	Bin Code
	Luminous flux
X/Y	Chromaticity Bin
V <sub>F</sub>	Forward Voltage
QTY	Packing Quantity
DATE	Made Date

Fig 2-3 Label Form Specification

### 2.2 Moisture Resistant Packing

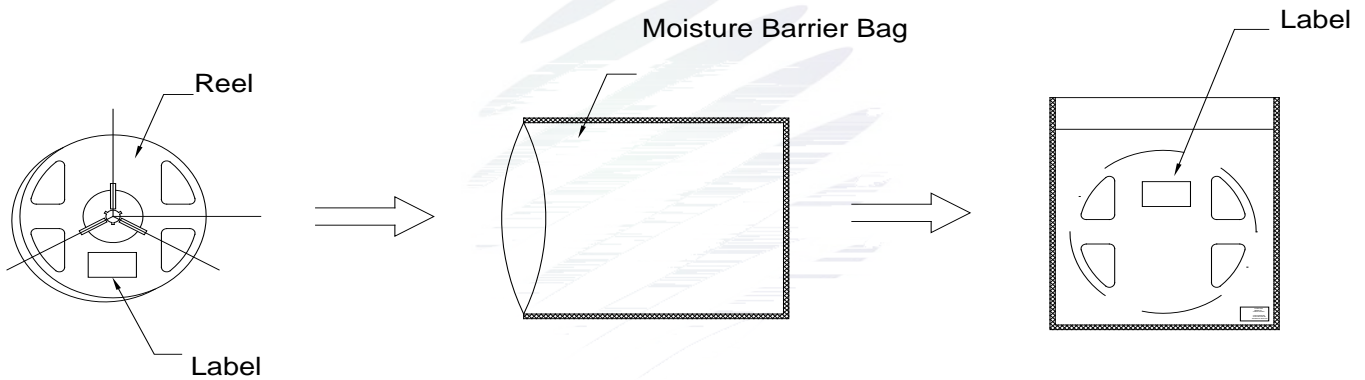

Fig.2- Moisture Resistant Packing

### 2.3 Cardboard Box

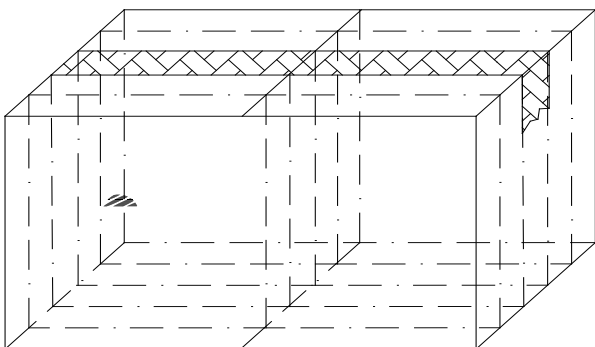

Fig.2-5 Cardboard Box



## 2.5 Criteria For Judging Damage

Table Criteria For Judging Damage

Test Items	Symbol	Test Condition	Criteria For Judgement	
			Min.	Max.
Forward Voltage	$V_F$	$I_F=200\text{mA}$	-	U.S.L*)x1.1
Reverse Current	$I_R$	$V_R = 5\text{V}$	-	U.S.L*)x2.0
Luminous Flux		$I_F=200\text{mA}$	L.S.L*)x0.7	-

Notes

REFOND







## 4. Handling Precautions

(1) LED operating environment and sulfur element composition cannot be over 100PPM in the LED mating usage material. This is provided for informational purposes only and is not a warranty or endorsement.

>ED

100BB? .

(2) In order to prevent external material from getting into the inside of LED, which may cause the malfunction of LED, the single content of Bromine element is required to be less than 900PPM, the single content of Chlorine element is required to be less than 900PPM, the total content of Bromine element and Chlorine element in the external materials of the application products is required to be less than 1500PPM. This is provided for informational purposes only and is not a warranty or endorsement.

>ED

900BB?

900BB?

1500BB? .

(3) VOCs (Volatile organic compounds) emitted from materials used in the construction of fixtures can penetrate silicone encapsulants of LEDs and discolor when exposed to heat and photonic energy. The result can be a significant loss of light output from the fixture. Knowledge of the properties of the materials selected to be used in the construction of fixtures can help prevent these issues. Refond a

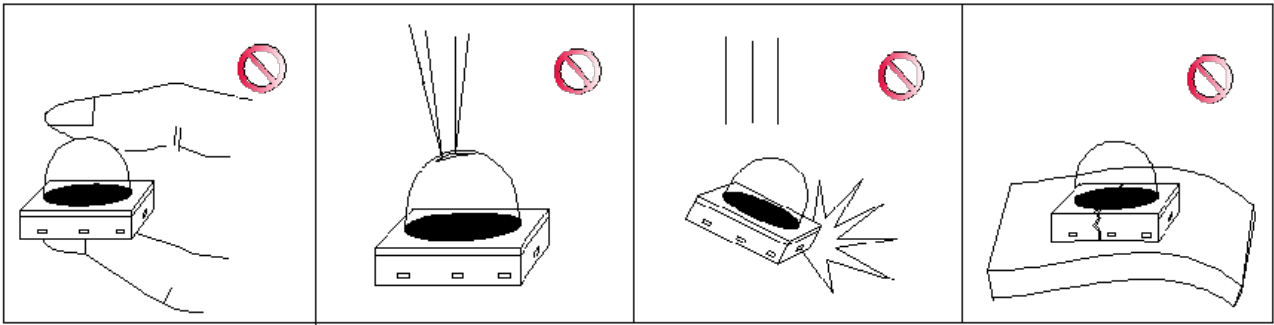

Fig 4-



Table 4-1 Storage

Conditions		Temperature	Humidity	Time
Storage	Before Opening Aluminum Bag	30	75%	Within 1 Year From Date
	After Opening Aluminum Bag	30	60%	168hours 168
Baking		60±5	-	24hours 24

(8) If the moisture absorbent material silica gel has faded away or the LEDs have exceeded the storage time baking treatment should be performed after unpacking and based on the following condition 60±5 for above 24 hours. 60

60±5 24

If the package is flatulence or damaged please notify the sales staff to assist.

(9) Similar to most Solid state devices; LEDs are sensitive to Electro-Static Discharge (ESD) and Electrical Over Stress (EOS). >ED

(10) Other points for attention, please refer to our relevant information.





Declare

This specification is written both in English and in Chinese and the latter is formal.