

±

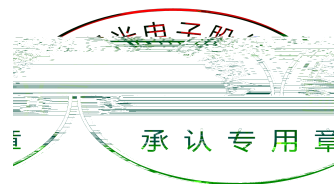

						μ

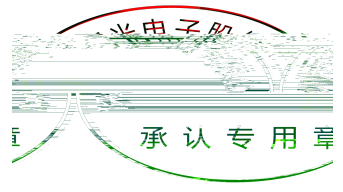

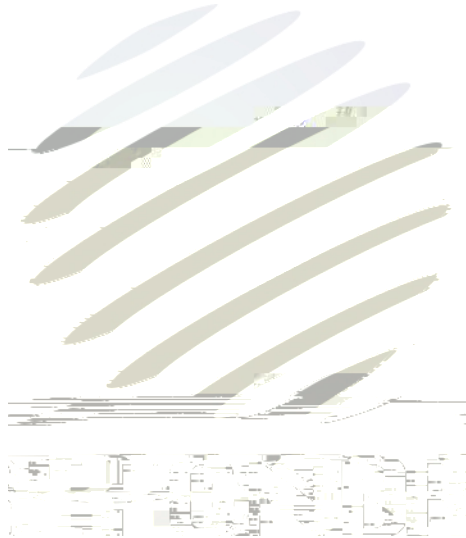

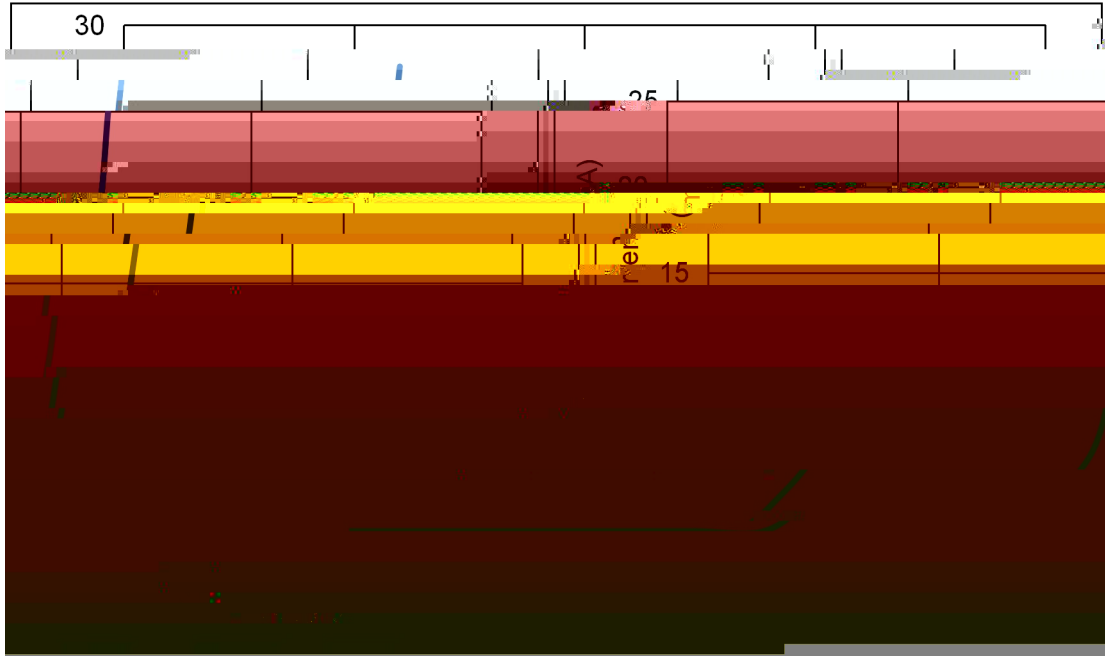

承认专用章

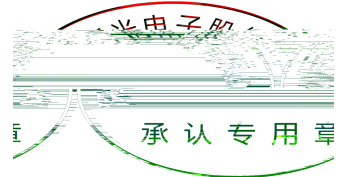
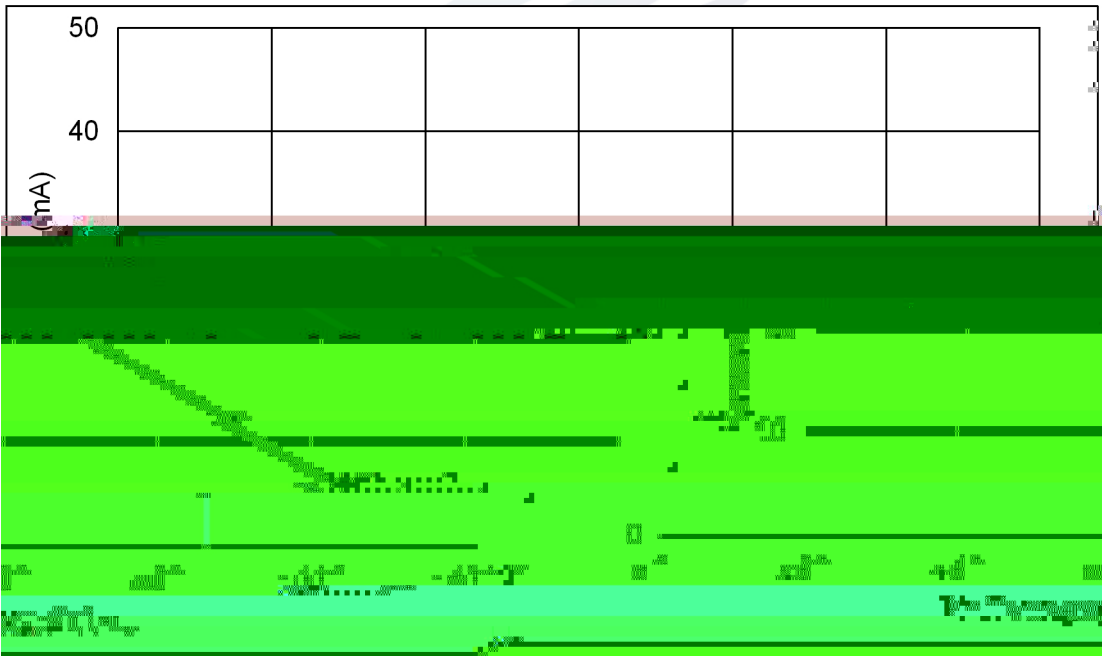
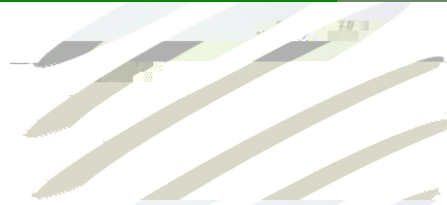
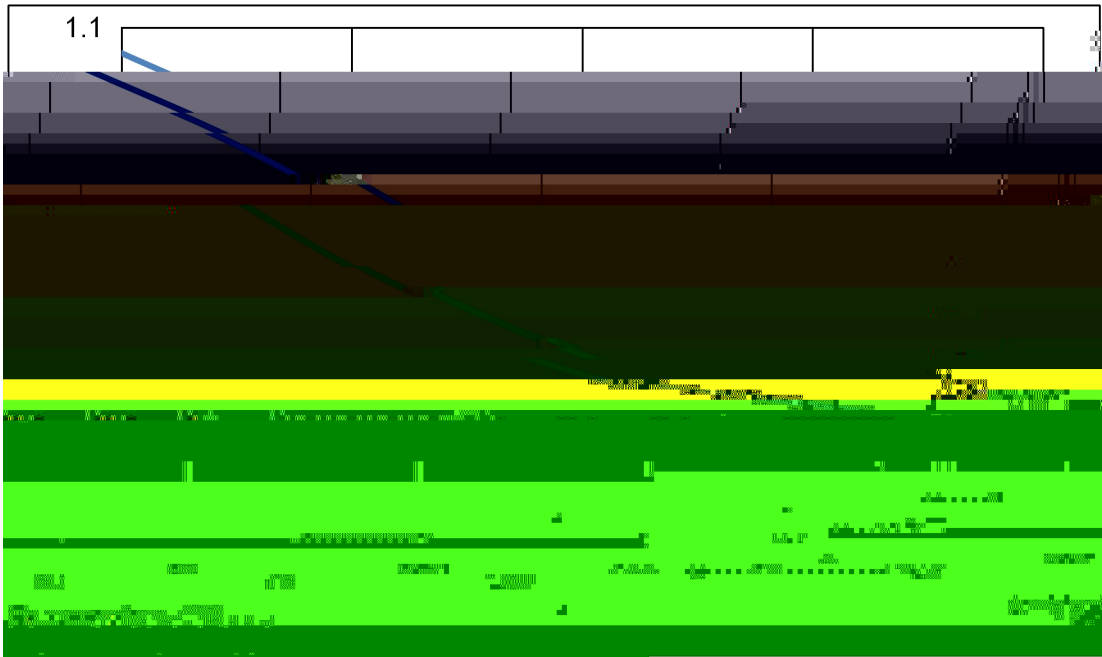



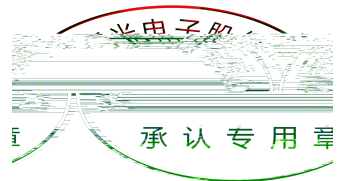
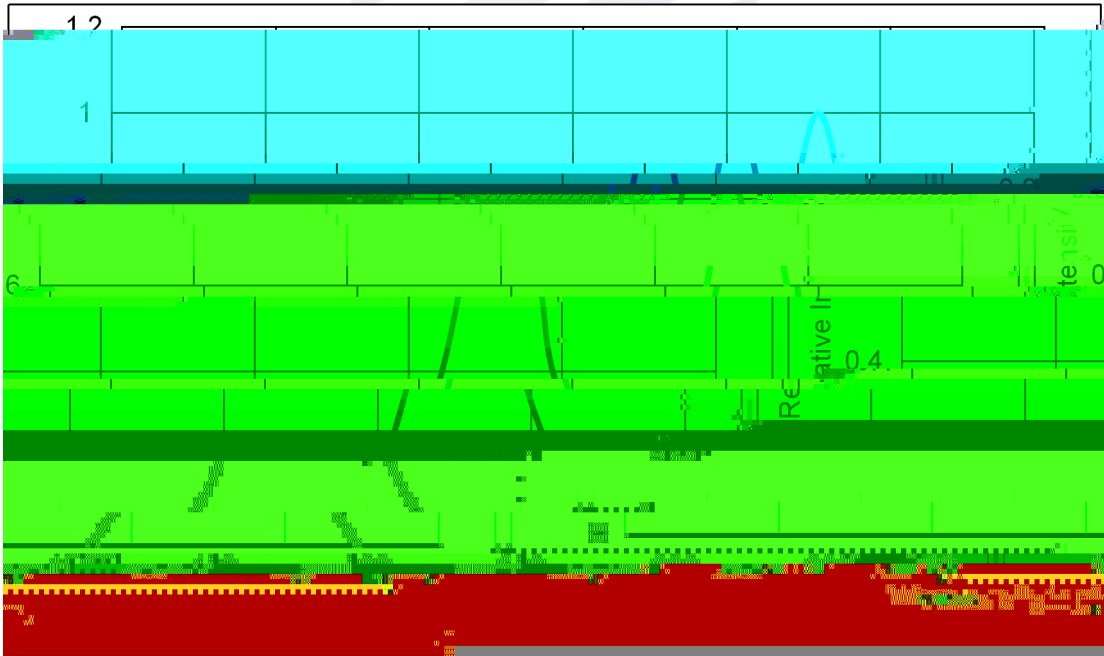
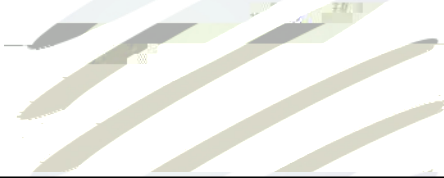
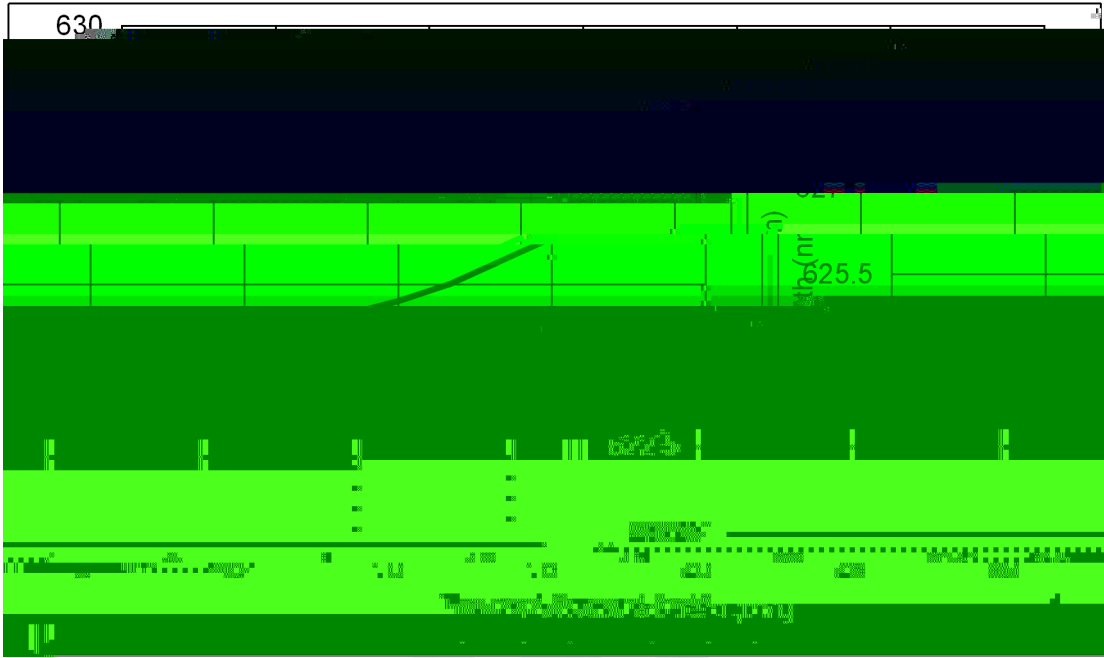

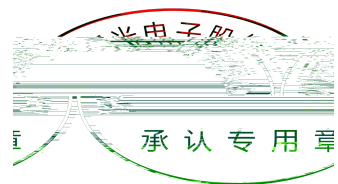
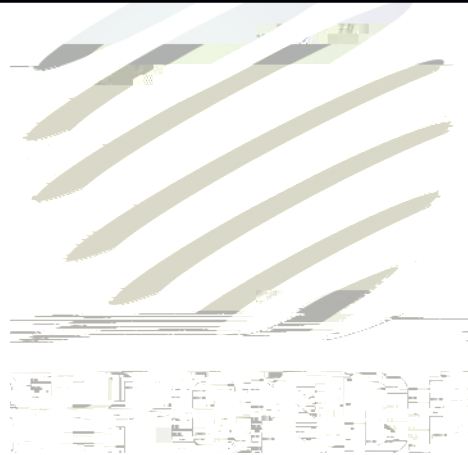
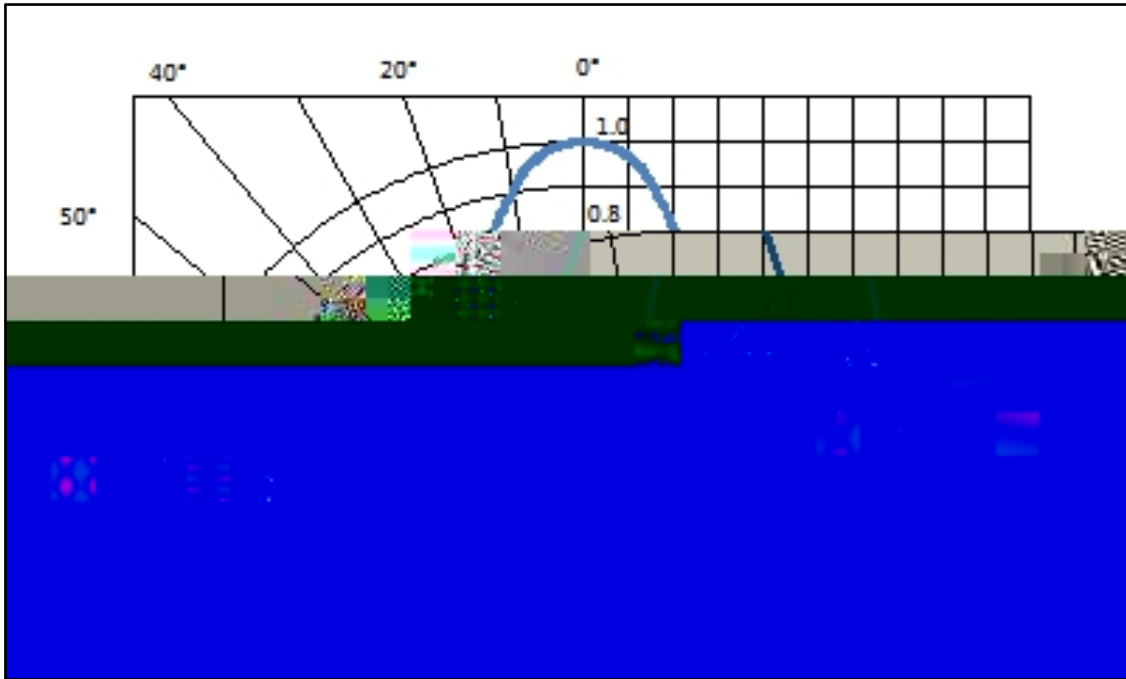

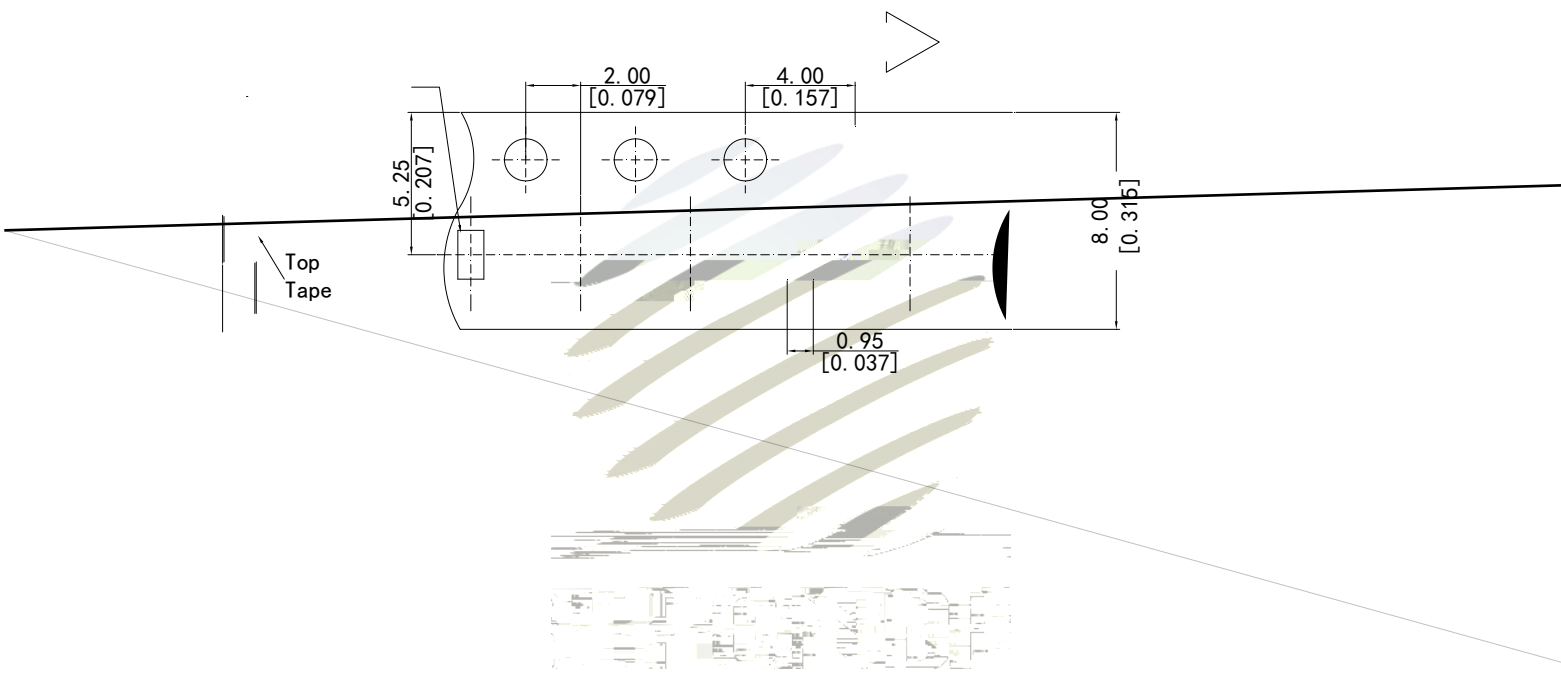



---

---

---

---

---

---

---

---

---

---

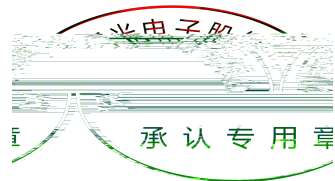
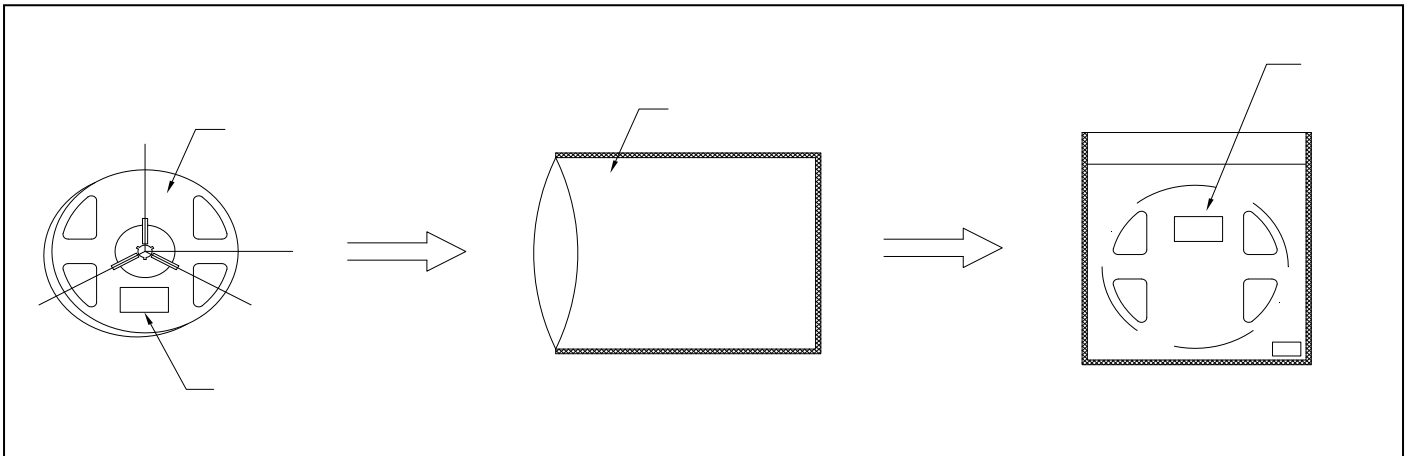



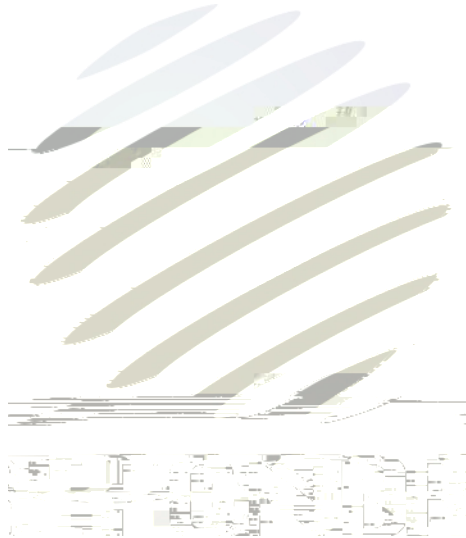

L @HG €D



