

±

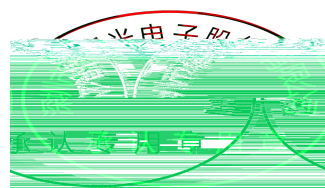

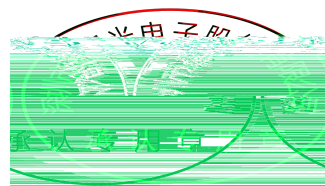





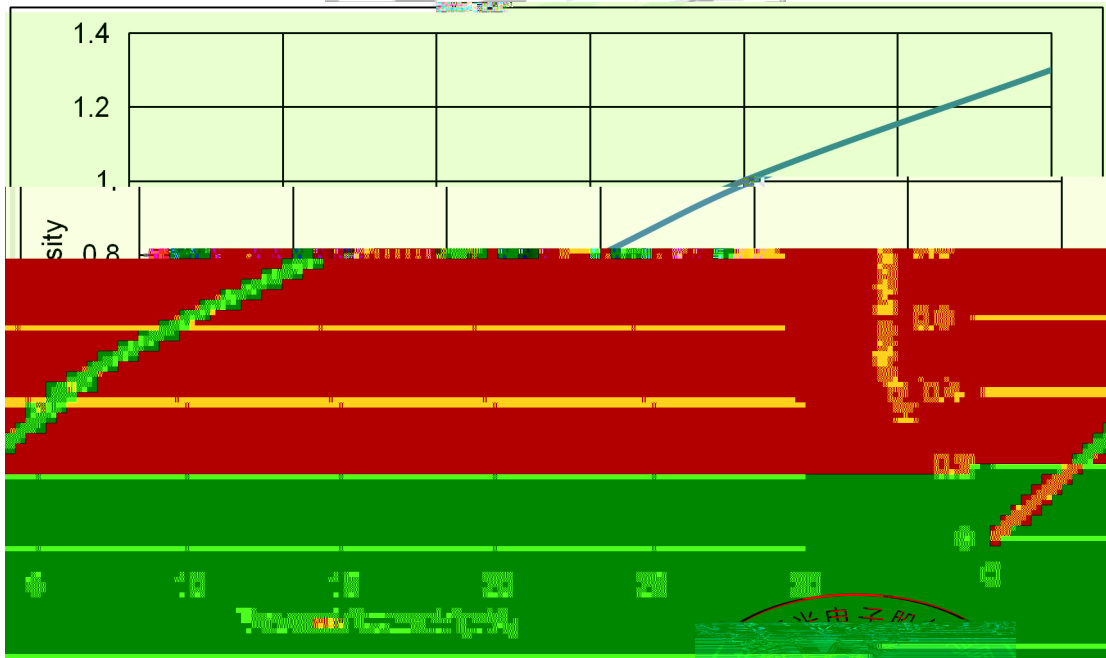
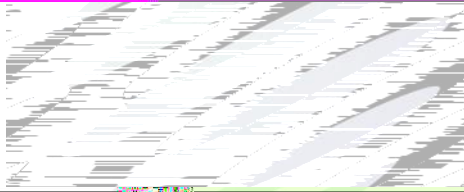
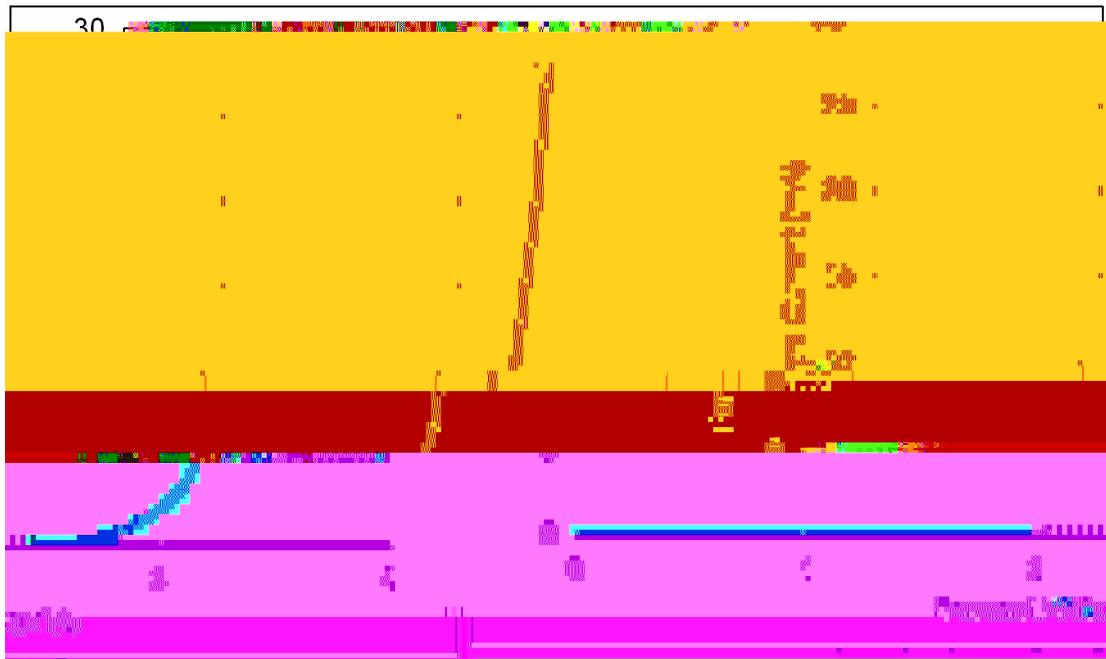

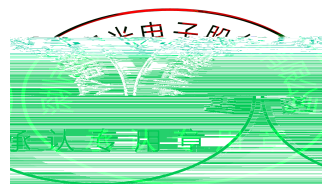
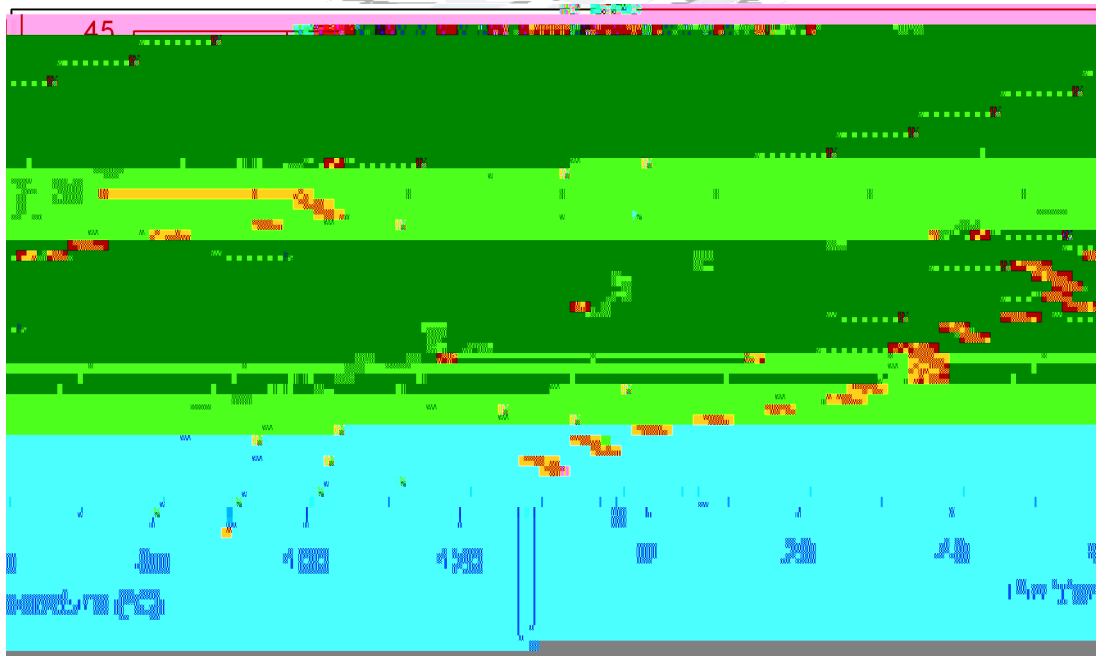
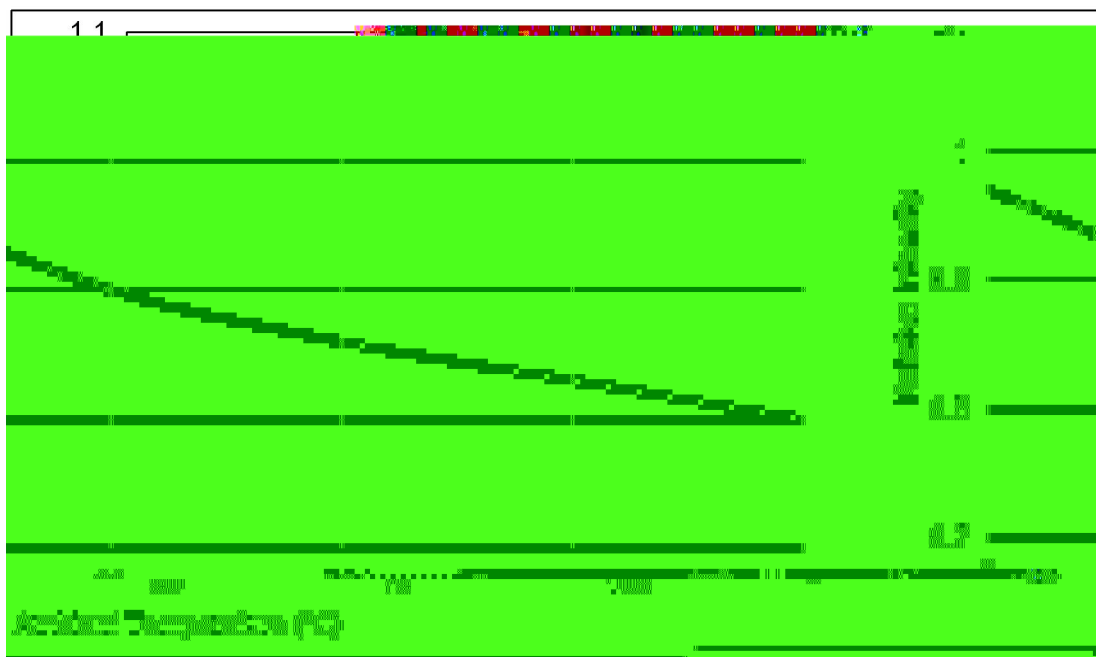

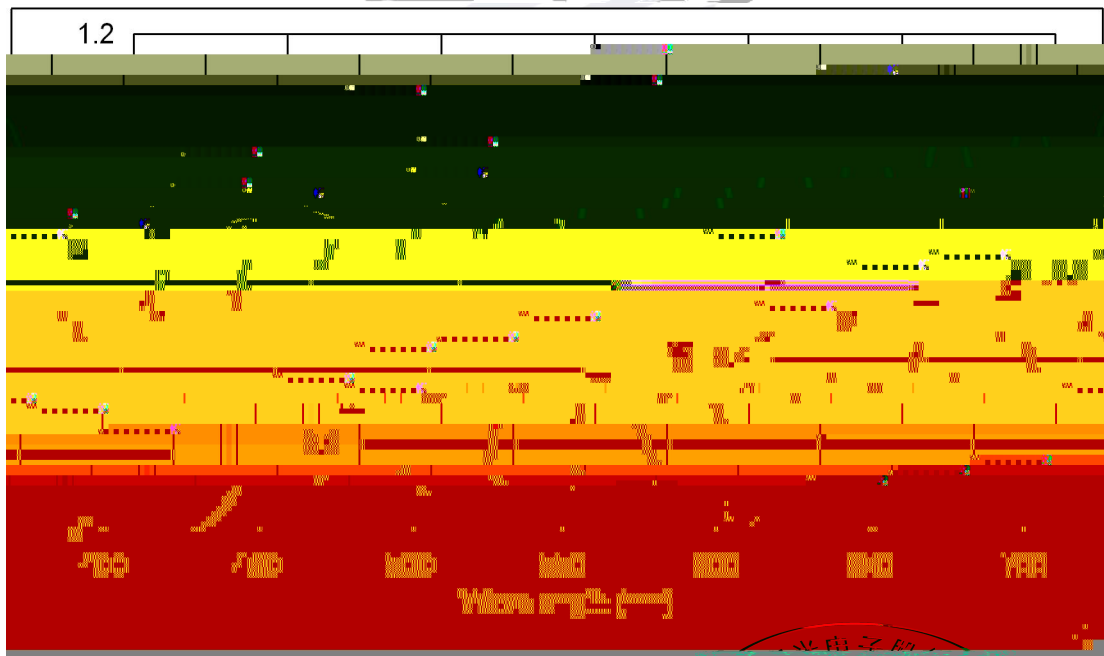
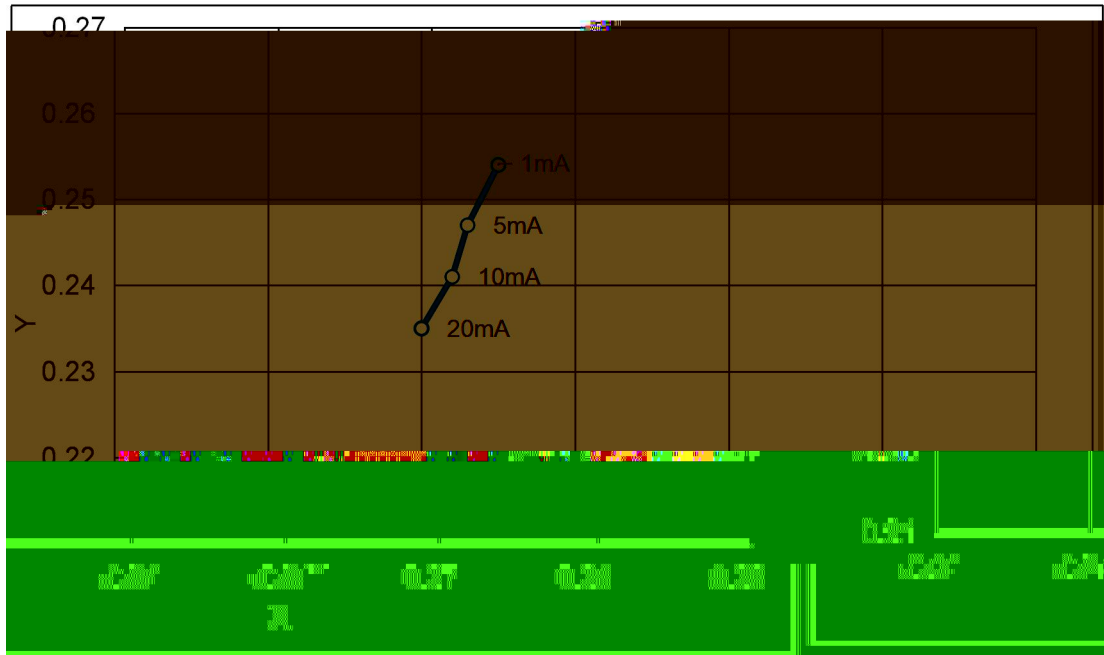

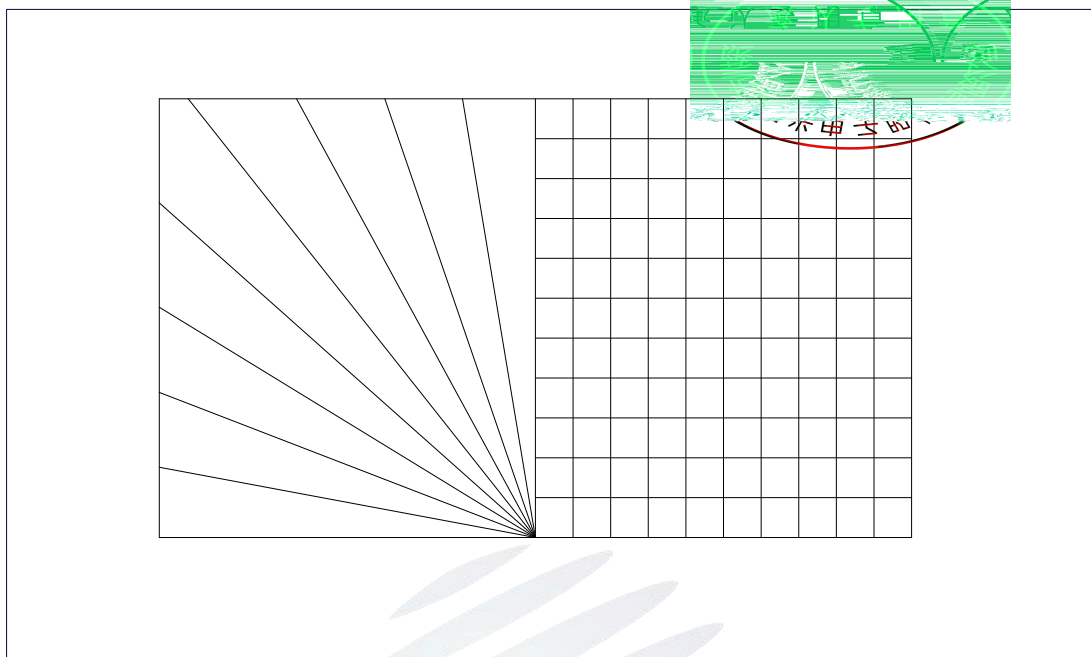

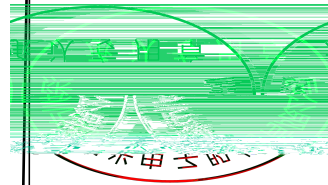

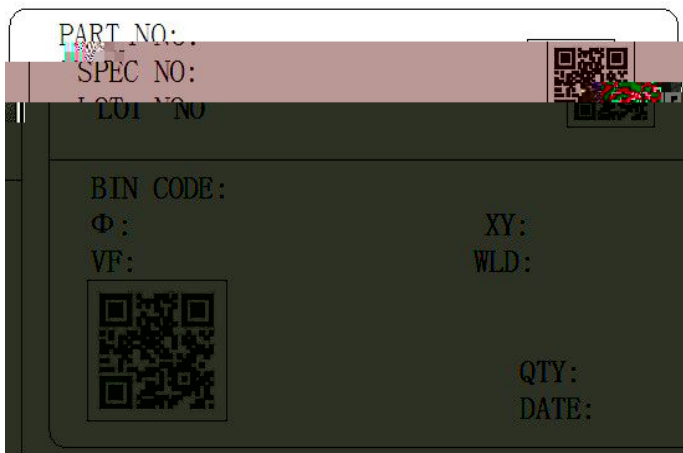

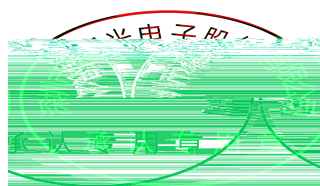
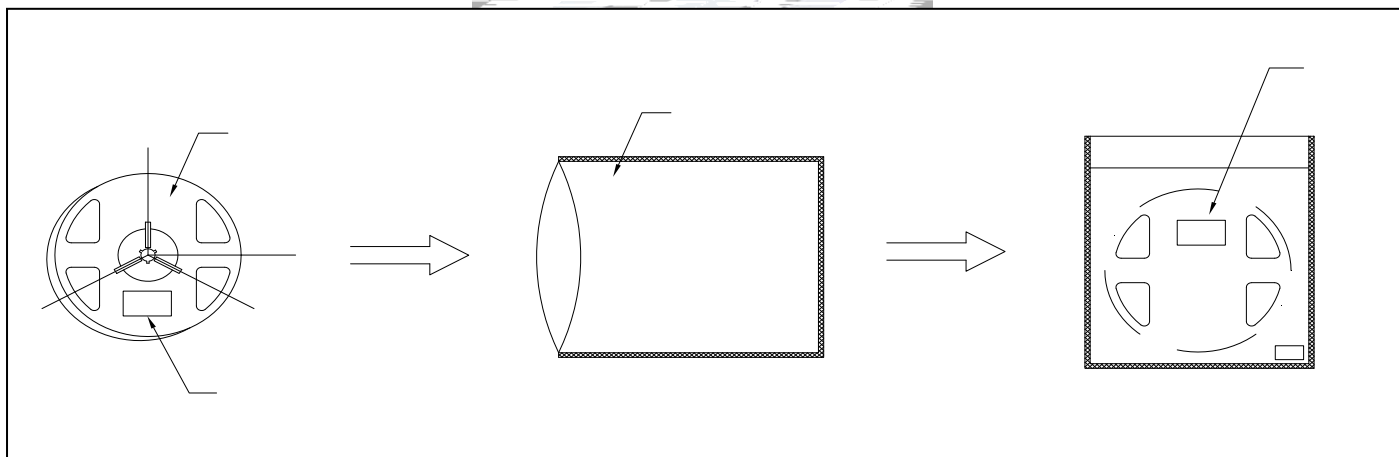



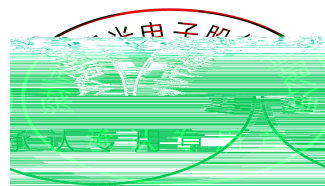

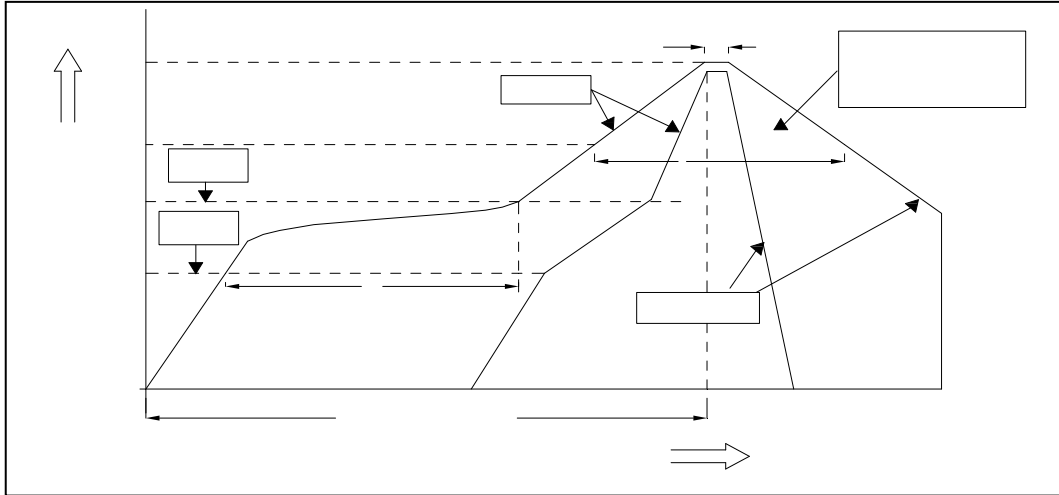

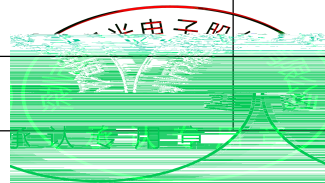

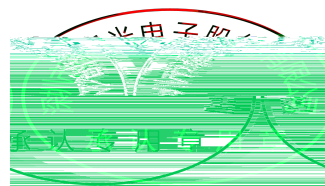

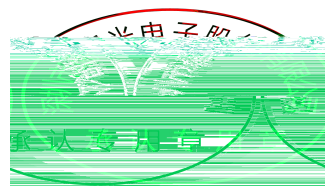





±

