

±

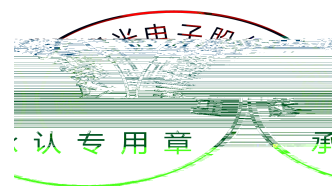

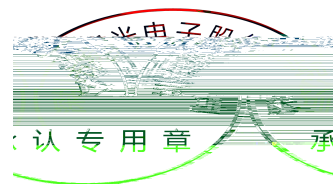

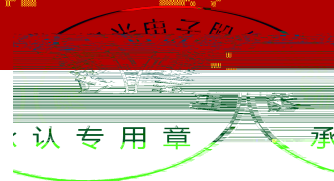

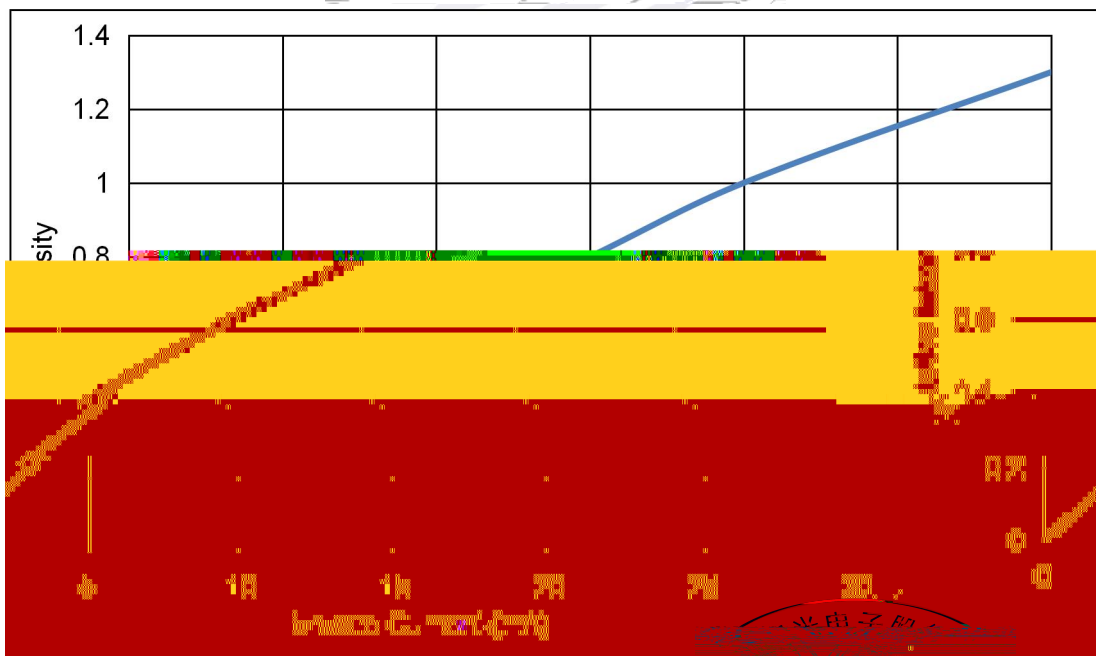
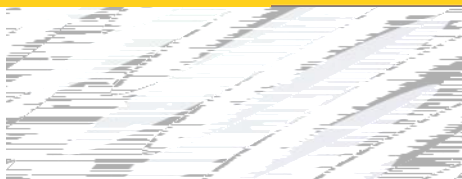
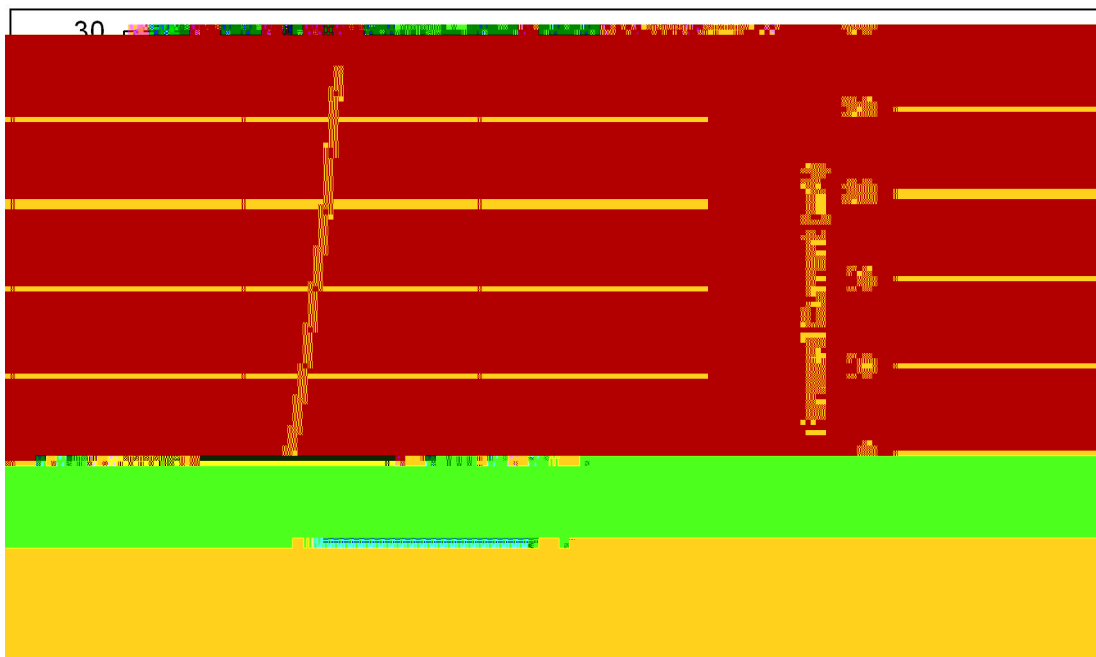

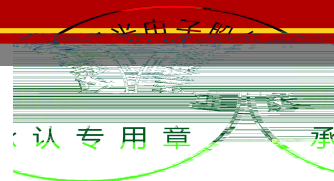
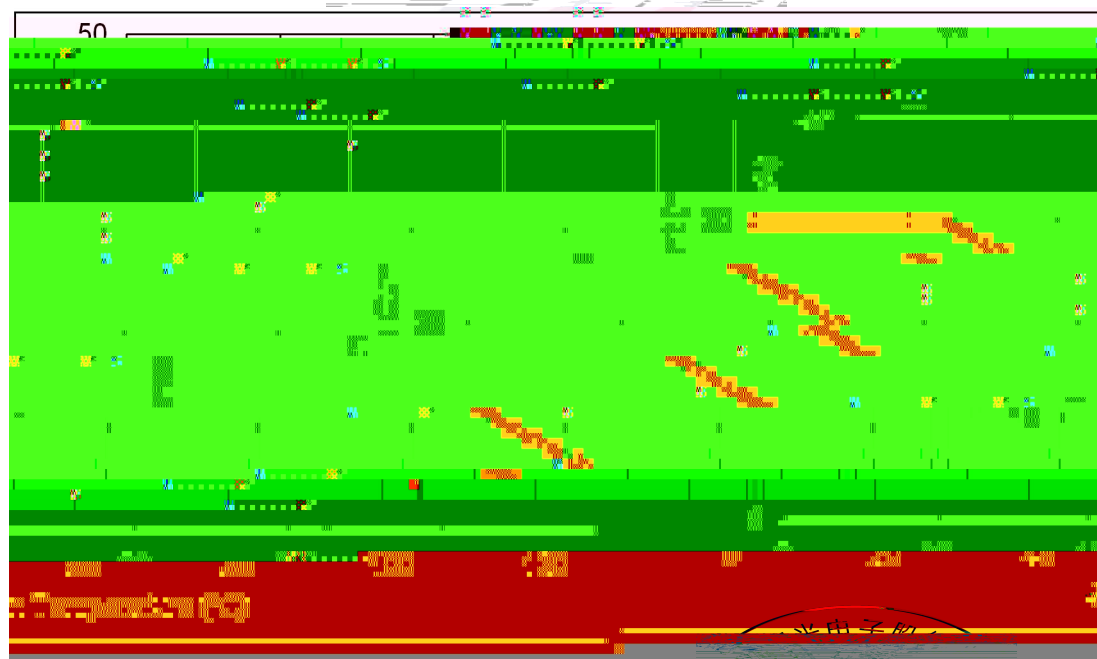
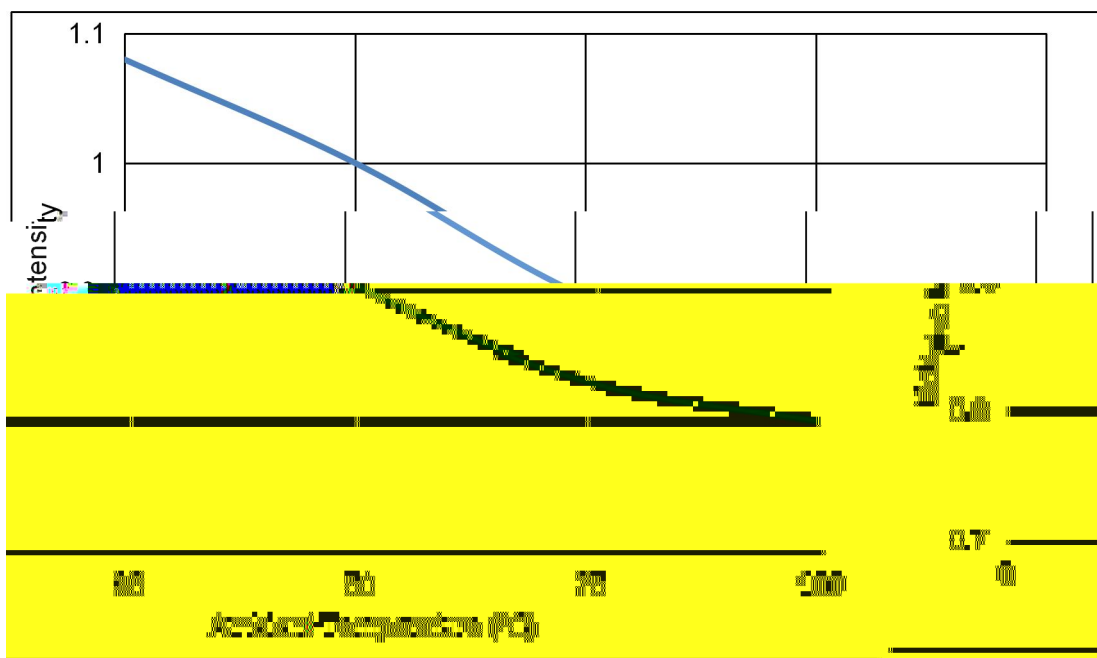

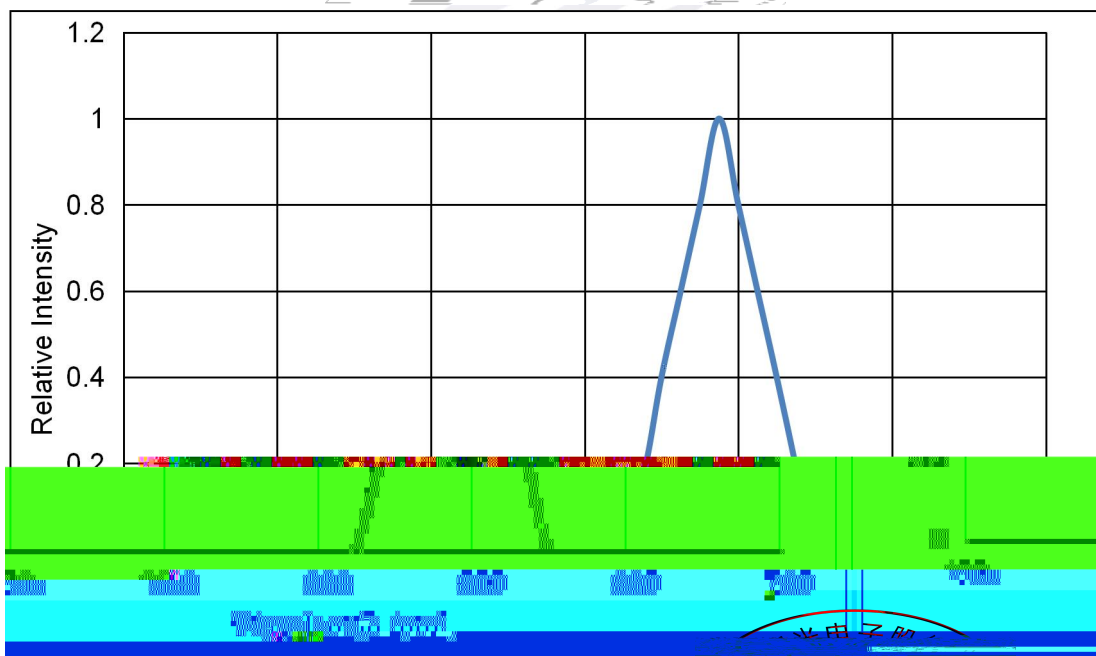
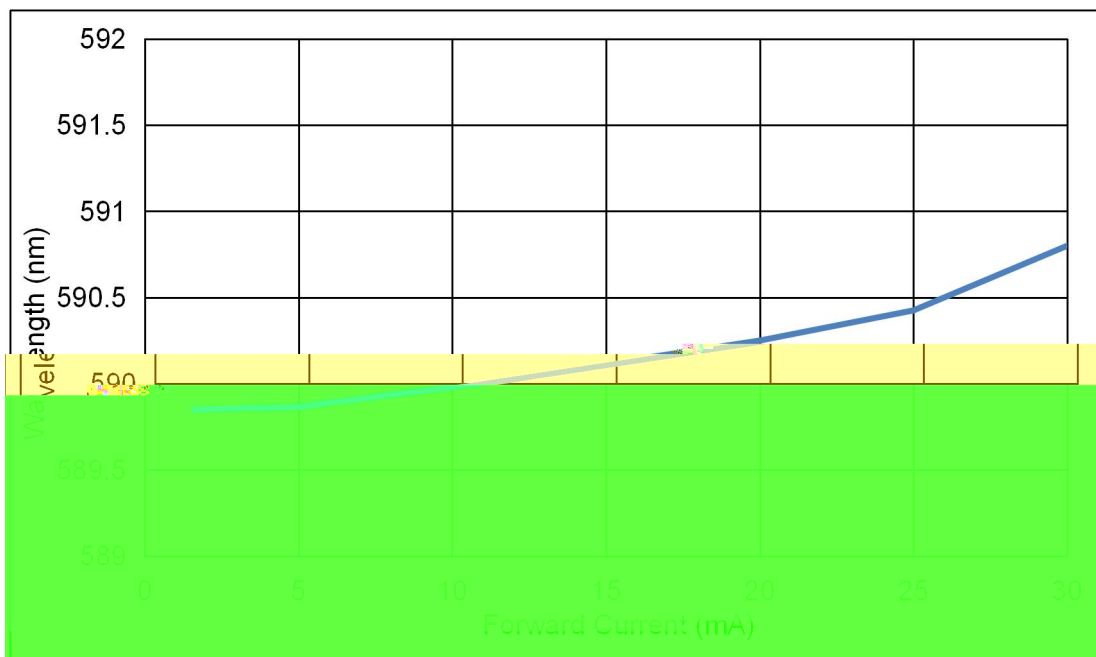

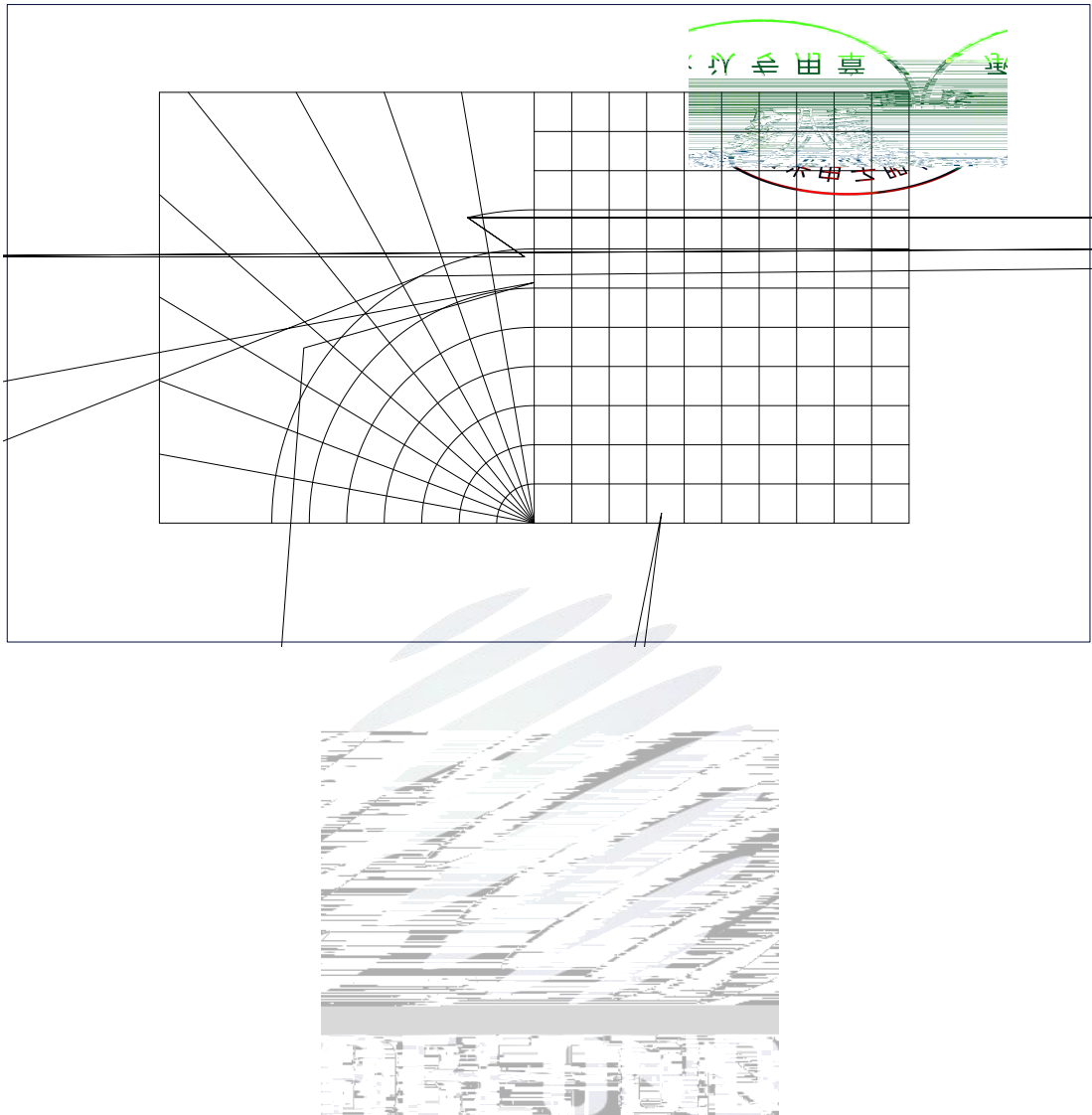

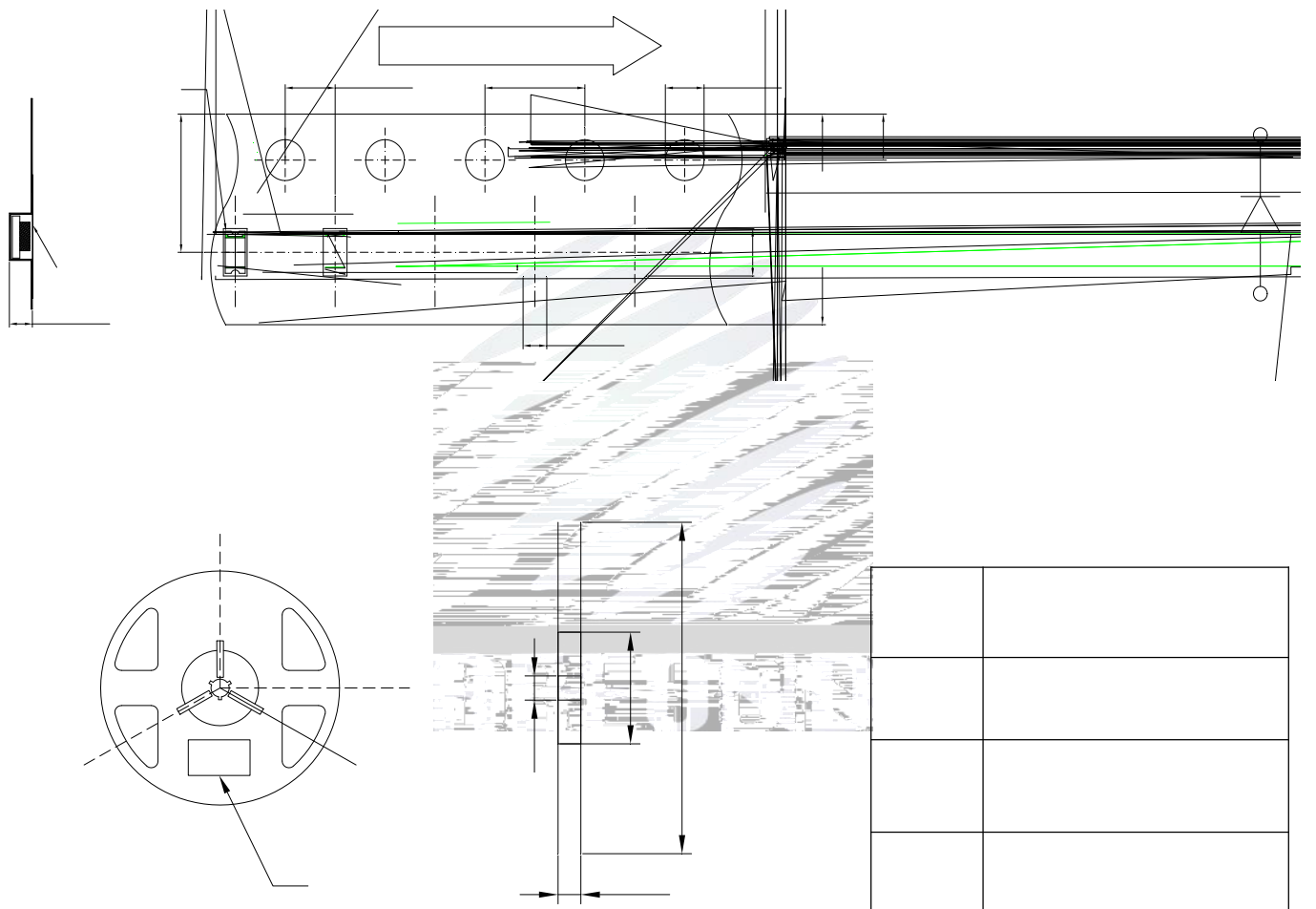



PART NO: [REDACTED]
 SPEC NO: [REDACTED]
 LOT NO: [REDACTED]

BIN CODE:
 Φ: XY:
 VF: WLD:

QTY:
 DATE:



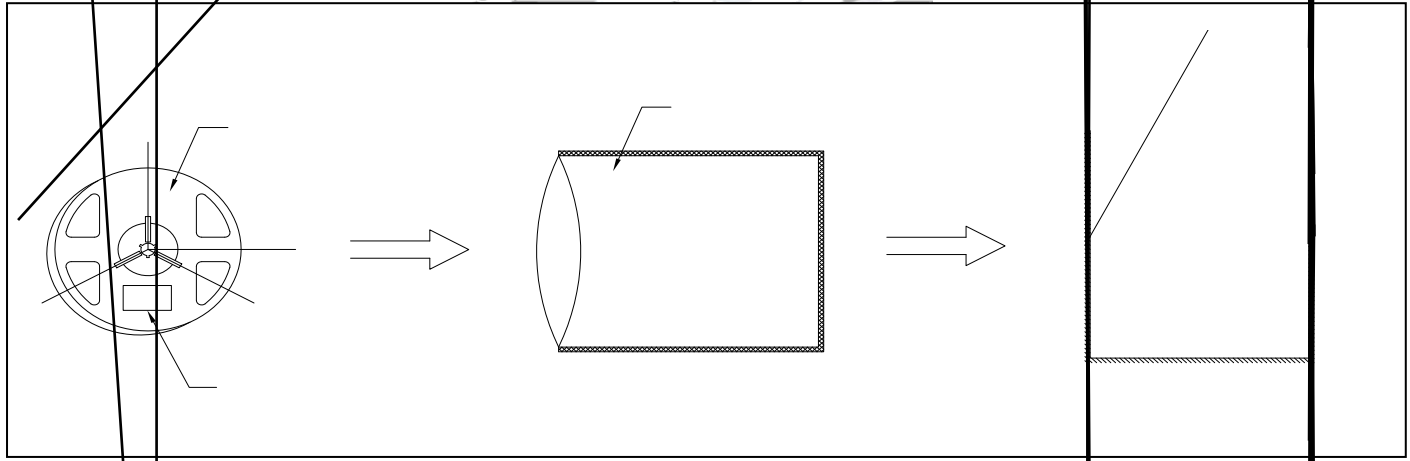

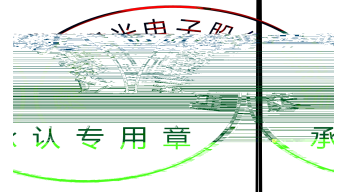

W

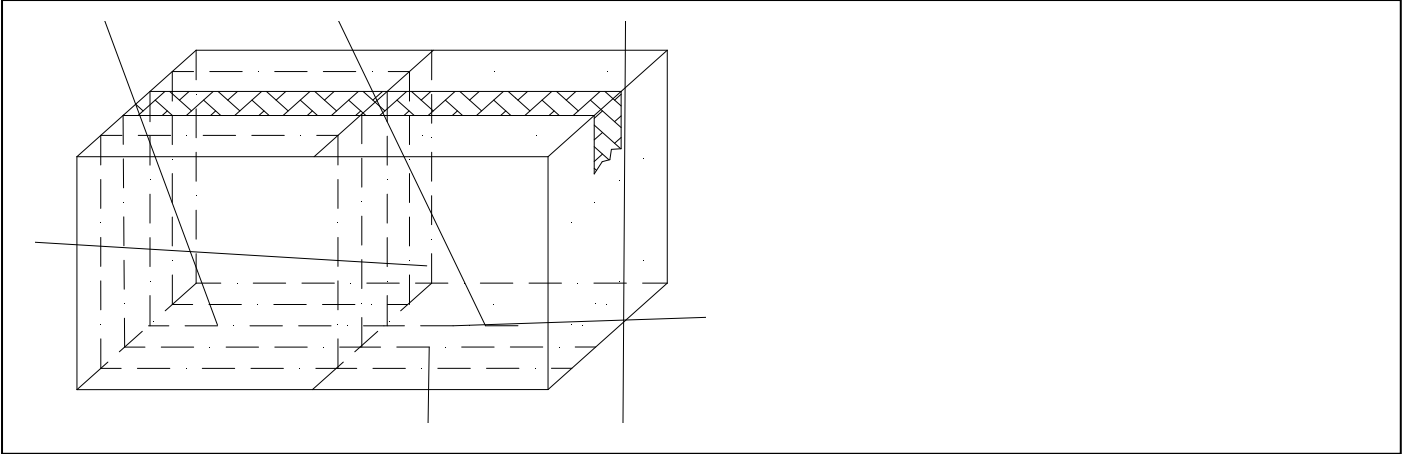

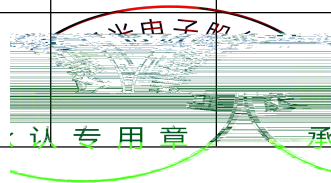



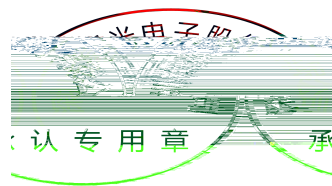

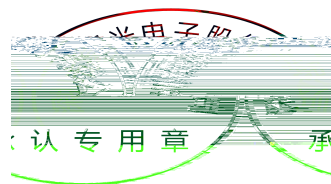

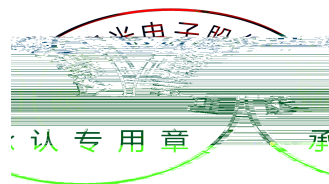



±

