

# SPECIFICATION

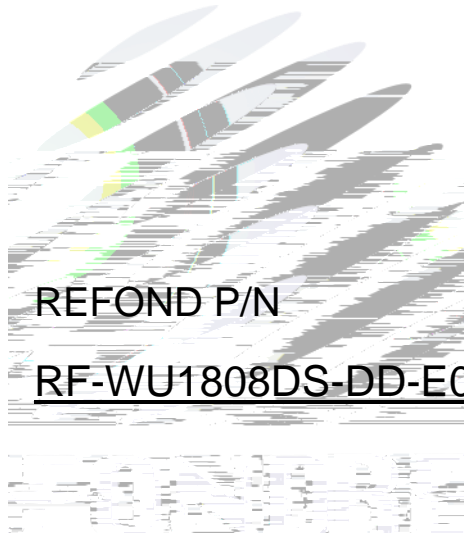

Mass Product

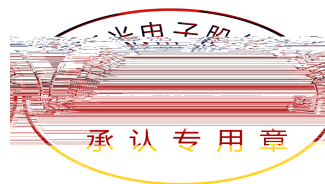

## Contents

1. Description	.....	3
1.1 General Description	.....	3
1.2 Features	.....	3
1.3 Application	.....	3
1.4 Package Dimension	.....	4
1.5 Product Parameters	.....	5
1.6 Bin Range Of Forward Voltage and Luminous Flux (IF=20mA)	.....	BIN
(IF=20mA).....	.....	7
1.7 Typical Optical Characteristics Curves	.....	8
2. Packaging	.....	12
2.1 Packaging Specification	.....	12
2.1.1 Carrier Tape Dimension	.....	12
2.1.2 Reel Dimension	.....	12
2.1.3 Label Form Specification	.....	13
2.2 Moisture Resistant Packing	.....	13
2.3 Cardboard Box	.....	14
2.4 Reliability Test Items And Conditions	.....	14
2.5 Criteria For Judging Damage	.....	15
3. SMT Reflow Soldering Instructions SMT	.....	16
3.1 SMT Reflow Soldering Instructions SMT	.....	16
4. Handling Precautions	.....	18
4.1 Handling Precautions	.....	18

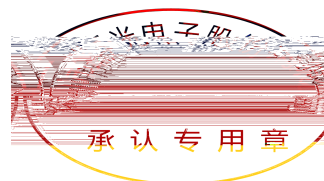

# 1. Description

## 1.1 General Description

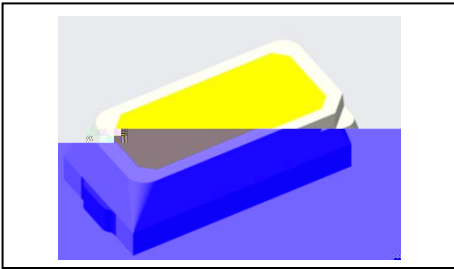

The White LED, which was fabricated by using a blue chip and the phosphor.  
 Product Package: 1.8mmX0.8mmX0.55mm.

## 1.2 Features

Extremely wide viewing angle.

Suitable for all SMT assembly and solder process.

Moisture sensitivity level: Level 3.

Level 3

RoHS compliant.

RoHS

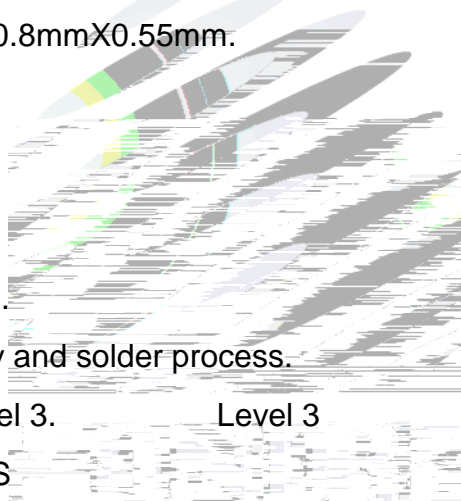

SMT

## 1.3 Application

Optical indicator.

Switch and Symbol, Display.

Household electrical appliances .

General use.

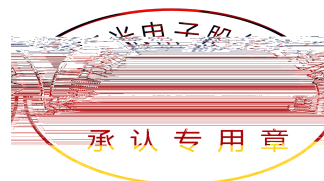

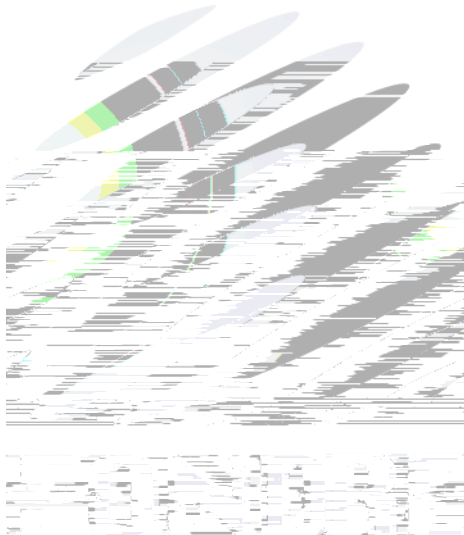

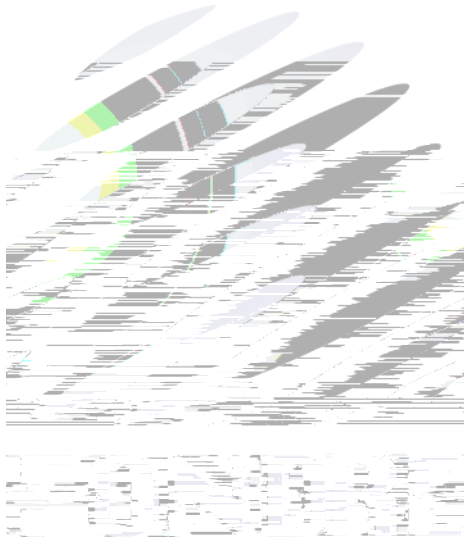
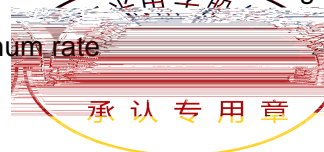

Table 1-2 Absolute Maximum Ratings at Ts=25°C

Parameter	Symbol	Rating	Units
Power Dissipation	Pd	105	mW
Forward Current	IF	30	mA
Peak Forward Current Of Pulse	IFP	60	mA
Electrostatic Discharge (HBM)	ESD	1000	V
Operating Temperature	Topr	-40 ~ +85	
Storage Temperature	Tstg	-40 ~ +85	
Junction Temperature	Tj	95	

## Notes

- 1/10 Duty cycle, 0.1ms pulse width.
- The above forward voltage measurement allowance tolerance is  $\pm 0.1V$ .
- The above color coordinates measurement allowance tolerance is  $\pm 0.005$ .
- The above luminous intensity measurement allowance tolerance  $\pm 10\%$ .
- Care is to be taken that power dissipation does not exceed the absolute maximum rating of the product.
- All measurements were made under the standardized environment of Refond.
- When the LEDs are in operation the maximum current should be decided after measuring the package temperature, junction temperature should not exceed the maximum rate



## 1.6 Bin Range Of Forward Voltage and Luminous Flux (IF=20mA)

**BIN (IF=20mA)**

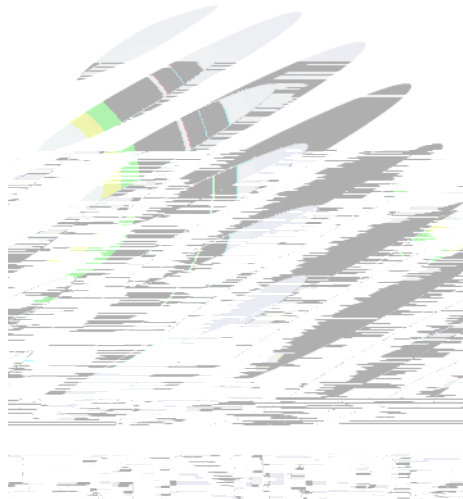

Fig. 1-6 The C.I.E Chromaticity Diagram CIE

Table 1-3 Bin Date Bin

BIN	X1	Y1	X2	Y2	X3
-----	----	----	----	----	----

### 1.7 Typical Optical Characteristics Curves

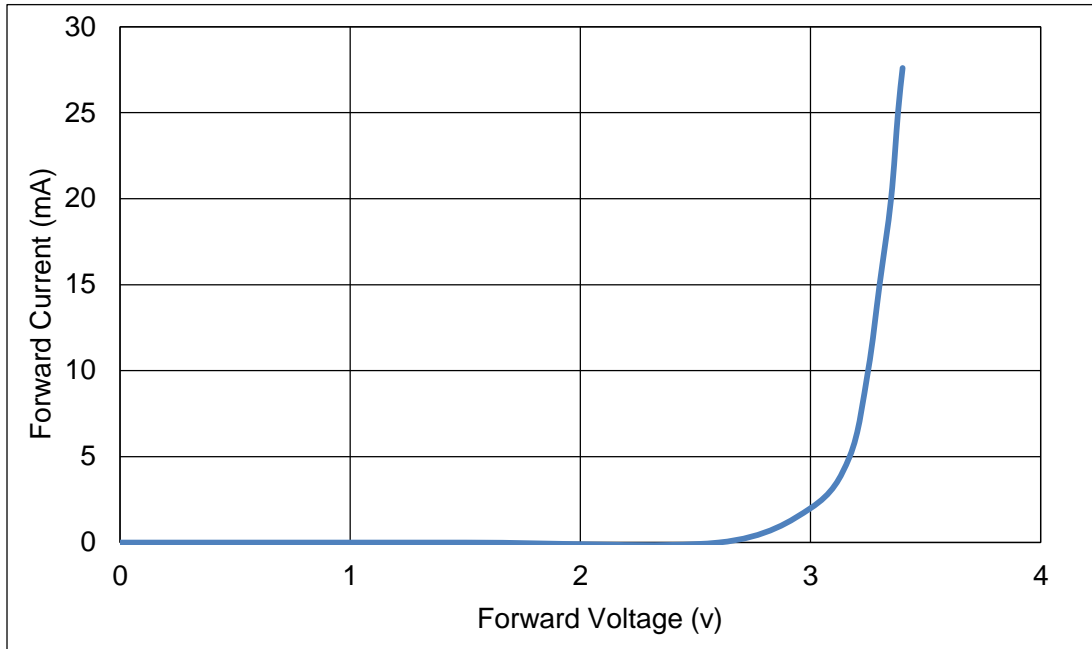

Fig. 1-7 Forward Voltage Vs Forward Current

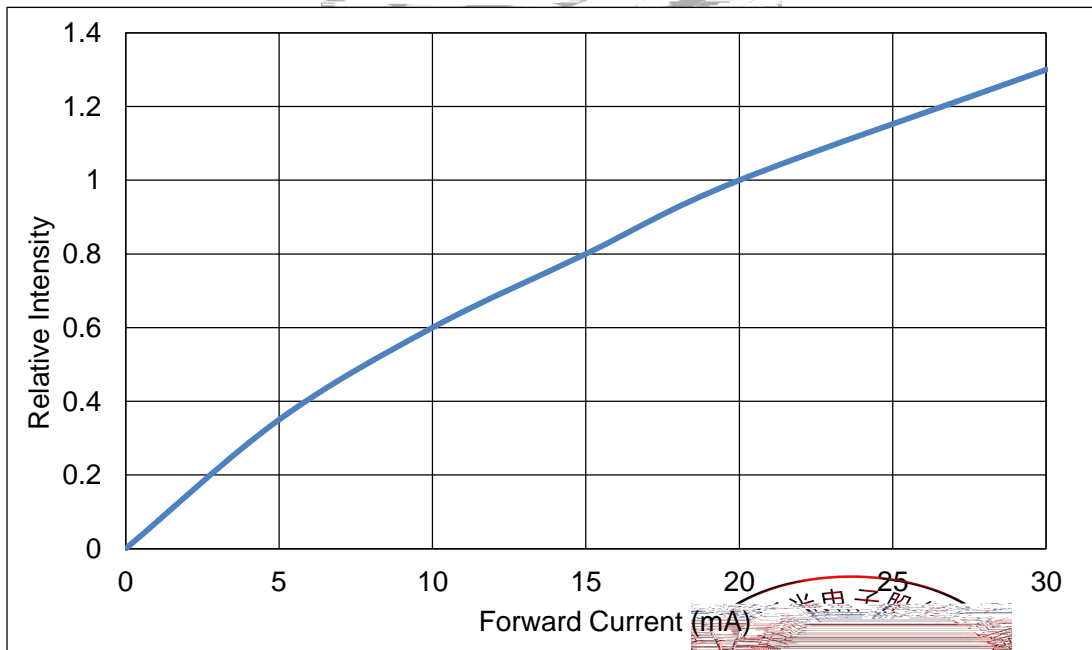
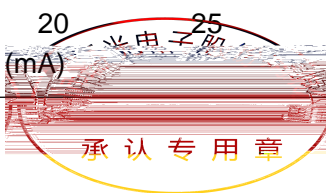

Fig. 1-8 Forward Current Vs Relative Intensity





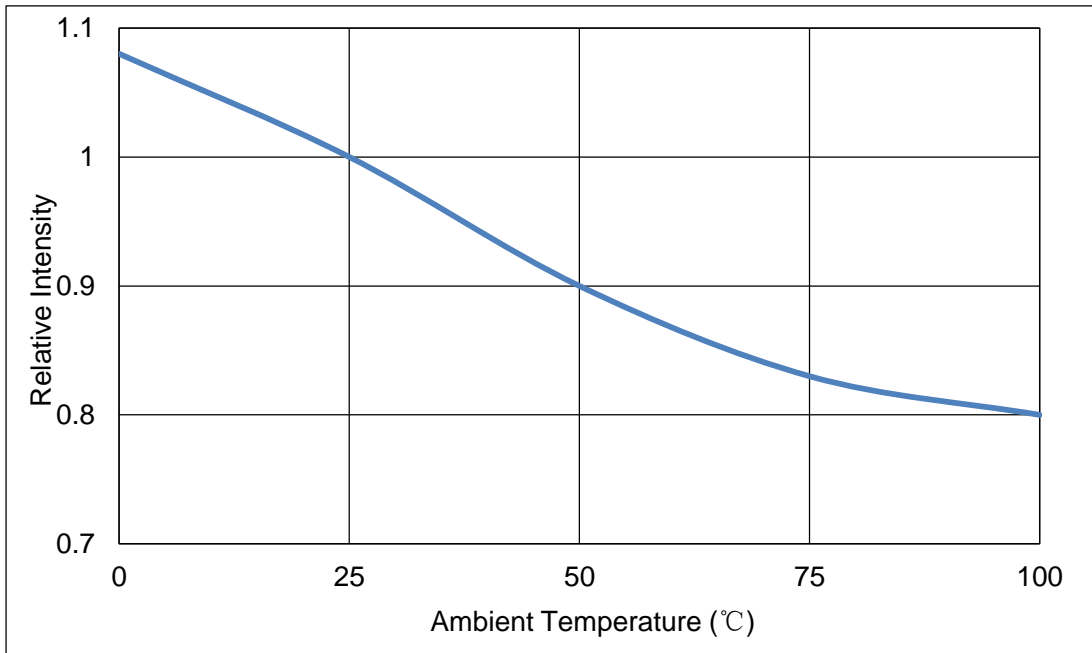

Fig. 1-9 Pin Temperature Vs Relative Intensity

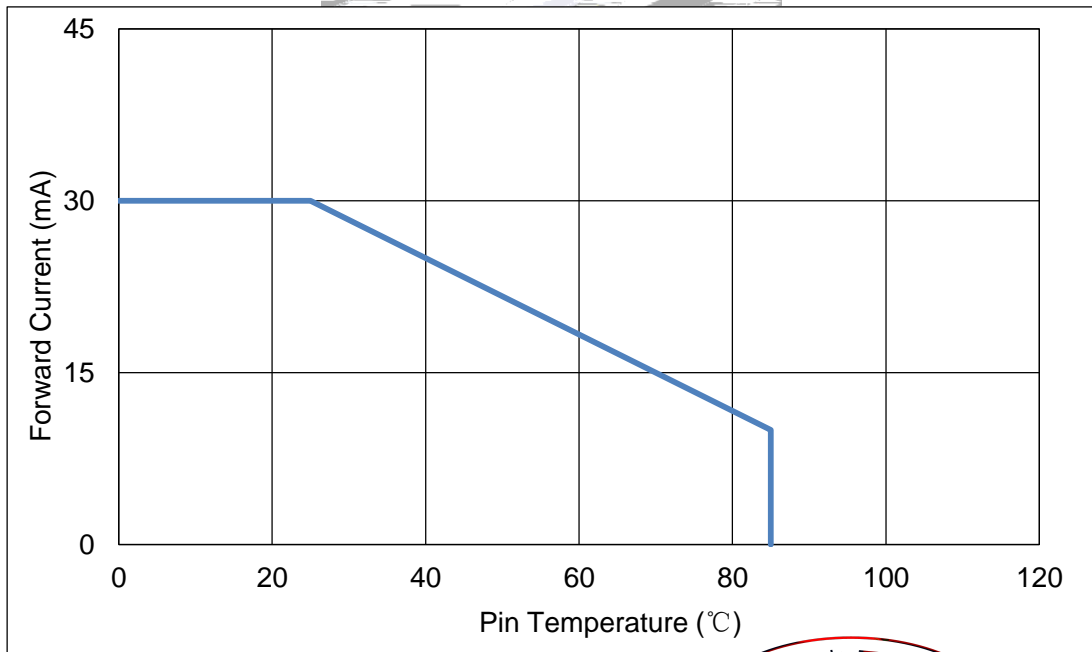
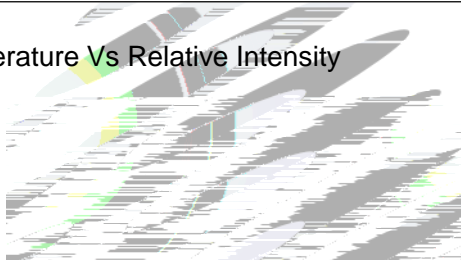
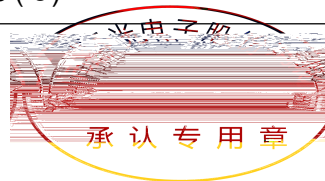

Fig. 1-10 Pin Temperature Vs Forward Current



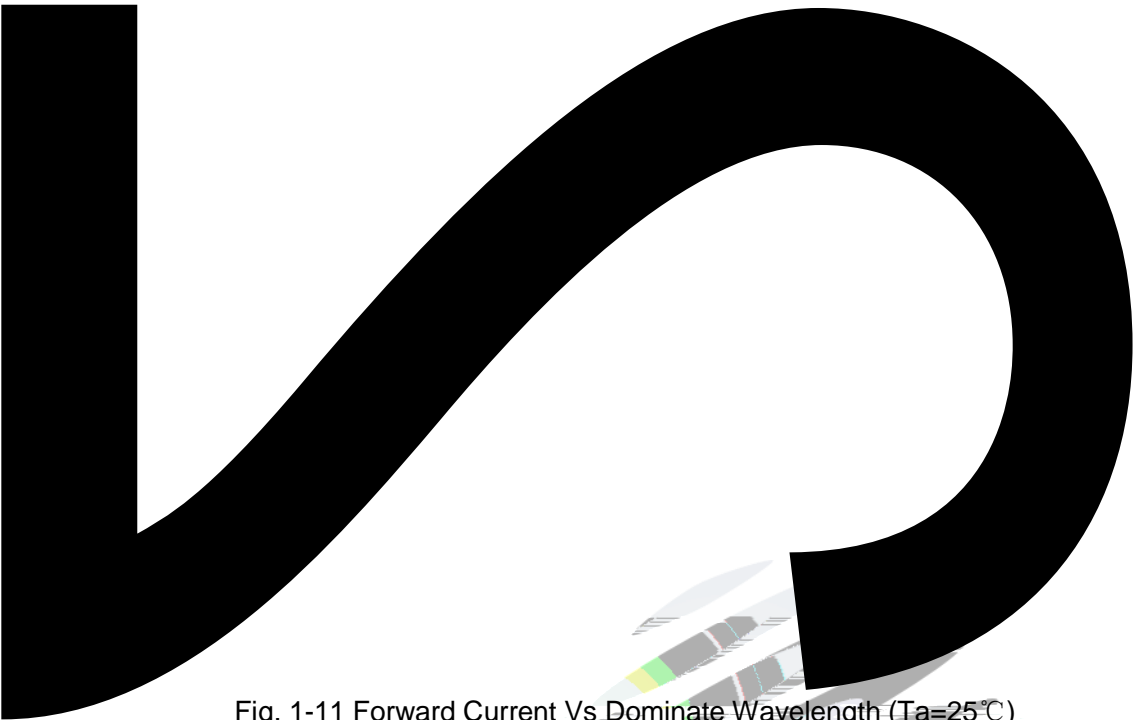

Fig. 1-11 Forward Current Vs Dominate Wavelength (Ta=25°C)

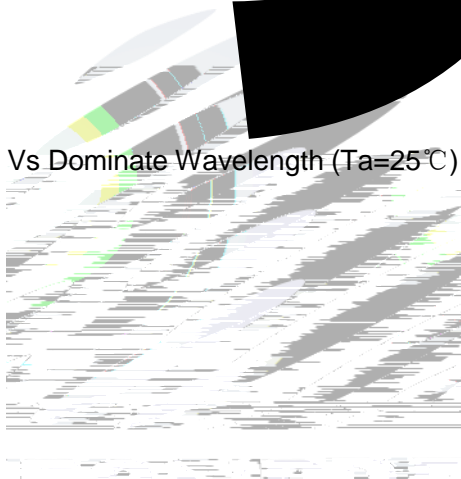

Fig. 1-12 -

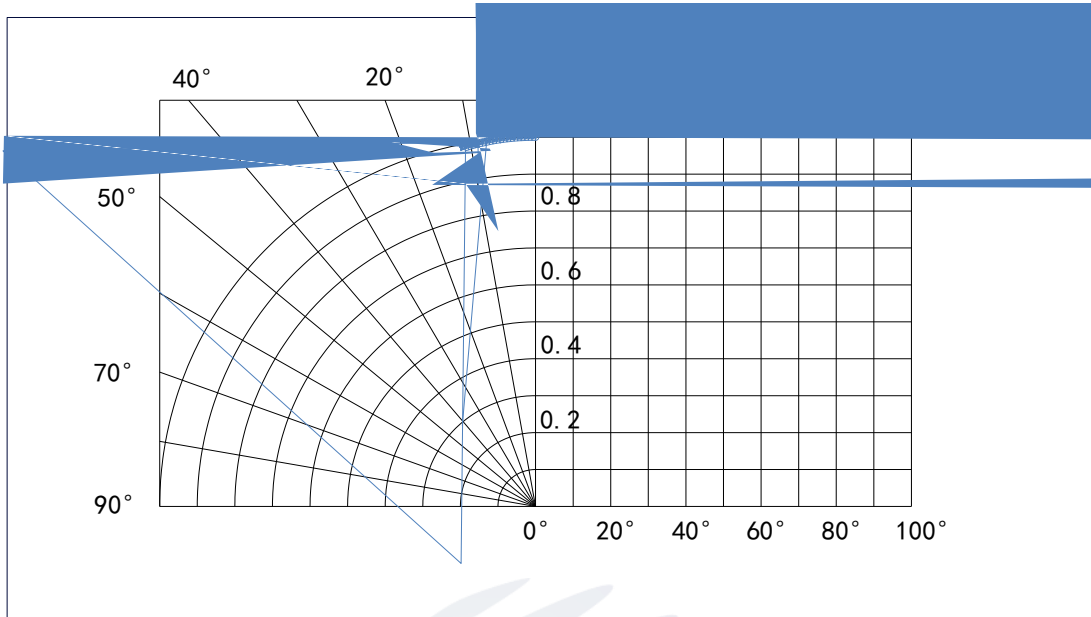
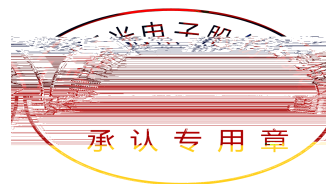
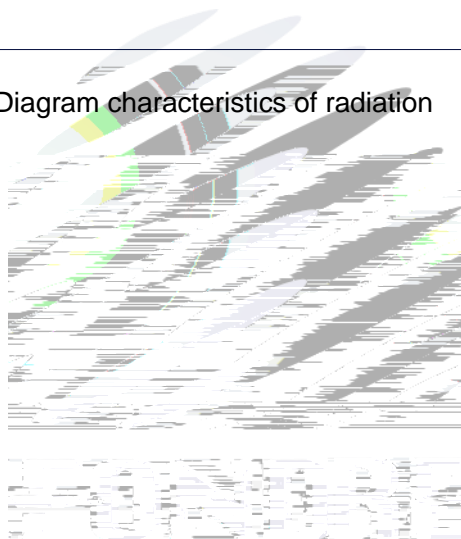

Fig. 1-13 Diagram characteristics of radiation



## 2. Packaging

### 2.1 Packaging Specification

Package:4000pcs/reel. 4000pcs

#### 2.1.1 Carrier Tape Dimension

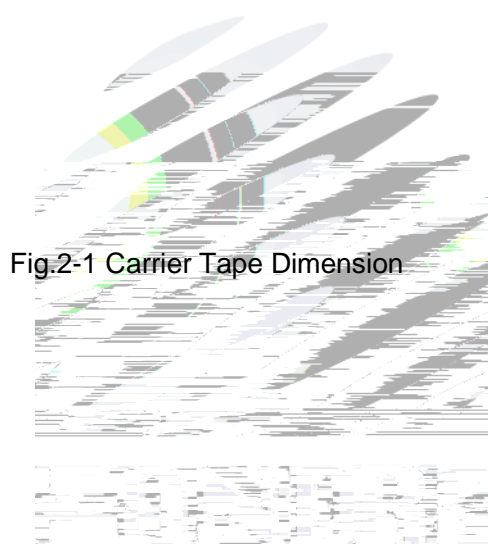

#### 2.1.2 Reel Dimension

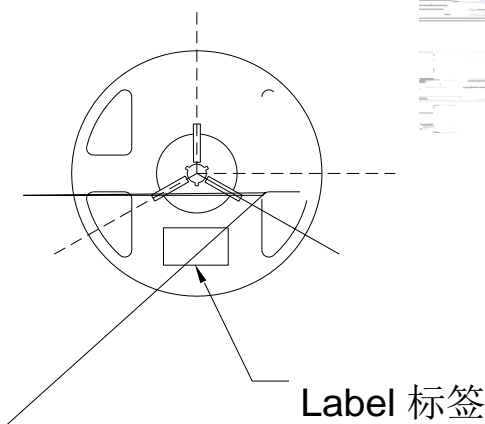

Fig.2-2 Reel Dimension

Table 2-1 Dimension

A	8.0 0.1mm
B	178 1mm
C	60 1mm
D	13.0 0.5mm

#### Notes

The tolerances unless mentioned  $\pm 0.1\text{mm}$ . Unit : mm

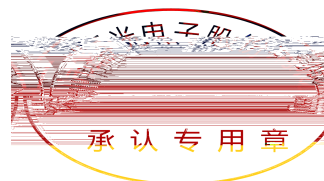

### 2.1.3 Label Form Specification

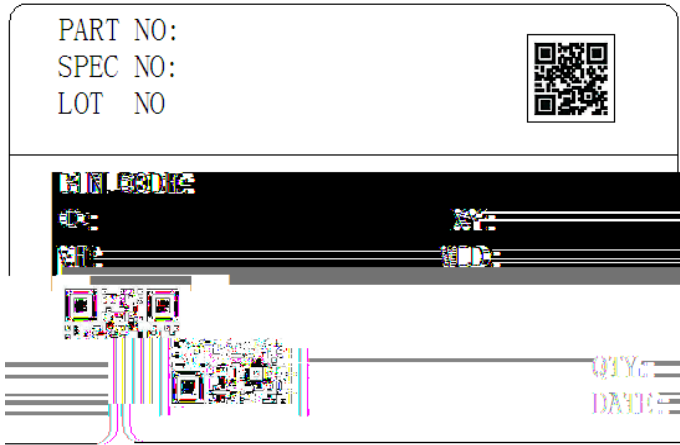

Fig. 2-3 Label Form Specification

Table 2-2 Parameter

PART NO.	Part Number
SPEC NO.	Spec Number
LOT NO.	Lot Number
BIN CODE	Bin Code
	Luminous flux
XY	Chromaticity Bin
V <sub>F</sub>	Forward Voltage
WLD	Wavelength
QTY	Packing Quantity
DATE	Made Date

### 2.2 Moisture Resistant Packing

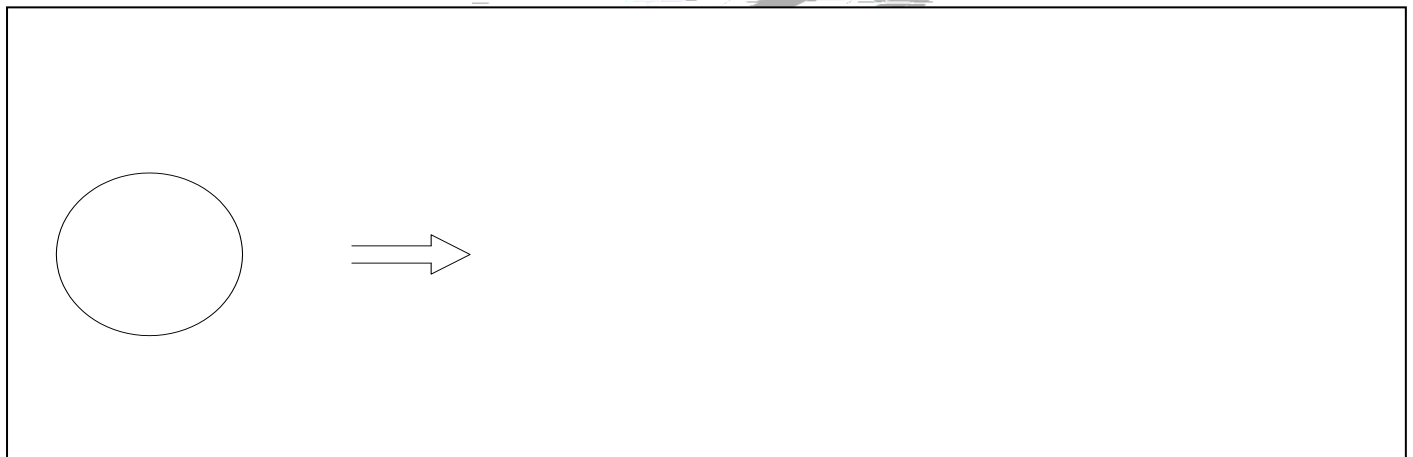
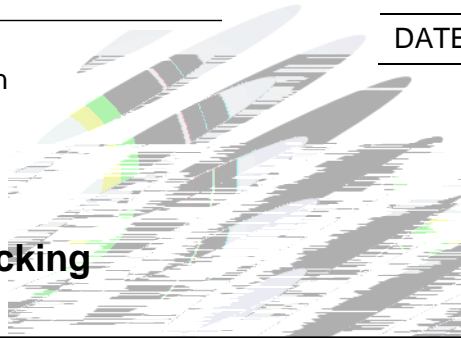
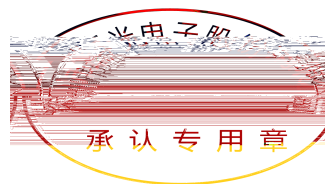
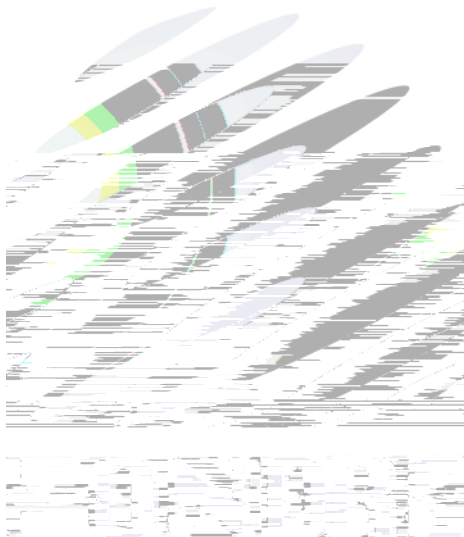

Fig.2-4 Moisture Resistant Packing





## 2.5 Criteria For Judging Damage

Table 2-4 Criteria For Judging Damage

Test Items	Symbol	Test Condition	Criteria For Judgement	
			Min.	Max.
Forward Voltage	$V_F$	$I_F=20mA$	-	U.S.L*)x1.1
Reverse Current	$I_R$	$V_R= 5V$	-	U.S.L*)x2.0
Luminous Flux		$I_F=20mA$	L.S.L*)x0.7	-

### Notes

1.U.S.L: Upper standard level

L.S.L: Lower standard level

2.The above reliability tests is based on the verification of a single/strip LED of Refond's existing experimental platform,the reliability experiment was taken under good heat dissipation conditions. When customers applies the LED to the series and parallel circuit,should take consideration of all the factors such as the current, voltage distribution, heat dissipation and others.

3.The technical information shown in the data sheets is limited to the typical characteristics and circuit examples of the referenced products. It does not constitute the warranting of industrial property nor the granting of any license.

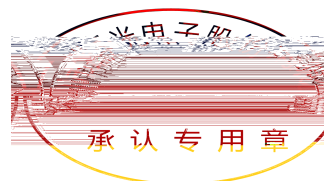

### 3. SMT Reflow Soldering Instructions SMT

#### 3.1 SMT Reflow Soldering Instructions SMT

Fig.3-1 SMT Reflow Soldering Instructions SMT

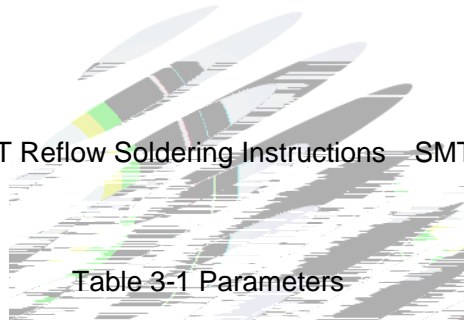

Table 3-1 Parameters

Average temperature rise speed	$T_{smax}$	$T_p$	3 °C/	Max 3 °C/ s
Preheating: minimum temperature	(T <sub>smin</sub> )		150 °C	
Preheating: Max temperature	(T <sub>smax</sub> )		200 °C	
Preheating: Time	T <sub>smin</sub>	T <sub>smax</sub>	60 - 120	60s-120s
Time limited to maintain high temperature: the temperature (T <sub>L</sub> )			217 °C	

Time limited to maintain high temperature: The Time

(t<sub>L</sub>)

60



Cooling speed	6 °C/	Max 6 °C/ s
25 °C	Needed time from 25 °C to Tp	8 Max 8 minutes

#### Notes

(1)Reflow soldering should not be done more than twice. If more than 24 hours between the two solderings, LED will be damaged.

(2)Whensoldering , do not put stress on the LEDs during heating.

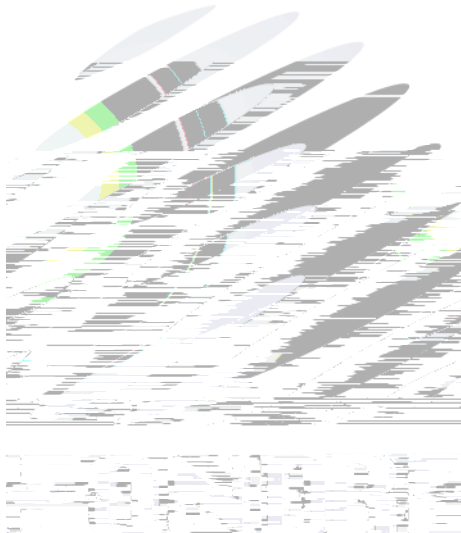

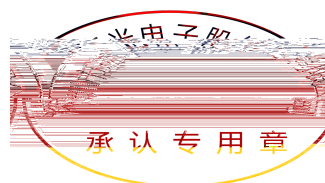

application and environment for which they are intended to be used. Attaching LEDs, do not use adhesives that outgas organic vapor.

(4) Handle the component along the side surface by using forceps or appropriate tools; Do not directly touch or Handle the silicone lens surface, it may damage the internal circuitry.

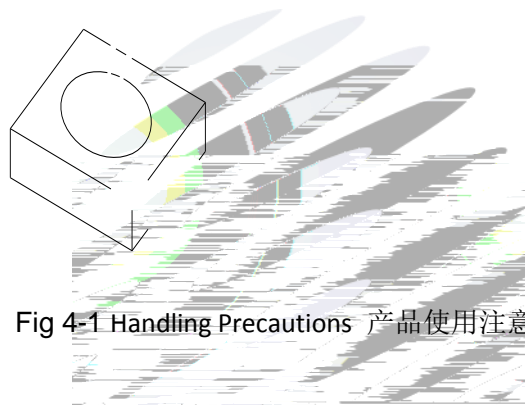

Fig 4-1 Handling Precautions 产品使用注意事项

(5) In designing a circuit, the current through each LED can not exceed the absolute maximum rating specified for each LED. In the meanwhile, resistors for protection should be applied, otherwise slight voltage shift will cause big current change, burn out may happen. The driving circuit must be designed to allow forward voltage only when it is ON or OFF. If the reverse voltage is applied to LED, migration can be generated resulting in LED damage.

(6) Thermal Design is paramount importance because heat generation may result in the Characteristics decline, such as brightness decreased, Color change and so on. Please consider the heat generation of the LEDs when making the system design. LED



(7) Compared to standard encapsulants, silicone is generally softer, and the surface is more likely to attract dust, requiring special care during processing. In cases where a minimal level of dirt and dust particles cannot be guaranteed, a suitable cleaning solution must be applied to the surface after the soldering of components. Refond suggests using isopropyl alcohol for cleaning. In case other solvents are used, it must be assured that these solvents do not dissolve the package or resin. Ultrasonic cleaning is not recommended. Ultrasonic cleaning may cause damage to the LED.

Table 4-1 Storage

Conditions		Temperature	Humidity	Time
Storage	Before Opening Aluminum Bag	30	75%	Within 1 Year From Date
	After Opening Aluminum Bag	30	60%	24hours 24
Baking		60 ± 5	-	24hours 24

(8) If the moisture absorbent material silica gel has faded away or the LEDs have exceeded the storage time, baking treatment should be performed after unpacking and based on the following condition  $65 \pm 5$  °C for above 24 hours.



If the package is flatulence or damaged, please notify the sales staff to assist.

(9) Similar to most Solid state devices; LEDs are sensitive to Electro-Static Discharge (ESD) and Electrical Over Stress (EOS).

(10) Other points for attention, please refer to our relevant information.

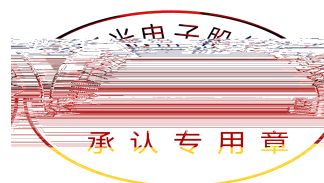
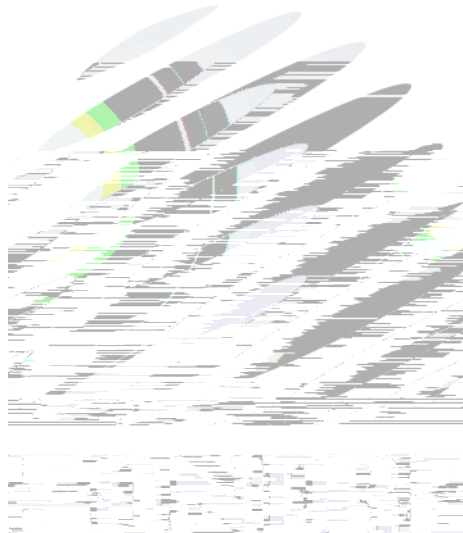





Declare

This specification is written both in English and in Chinese and the latter is formal.

