

SPECIFICATION

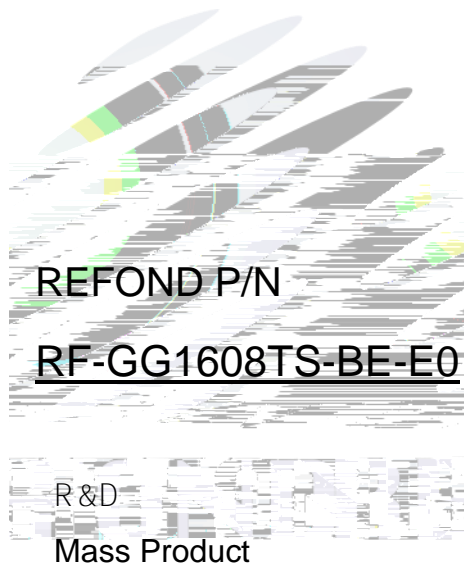

Contents

1. Description	3
1.1 General Description	3
1.2 Features	3
1.3 Application	3
1.4 Package Dimension	4
1.5 Product Parameters	5
1.6 Typical Optical Characteristics Curves	7
2. Packaging	11
2.1 Packaging Specification	11
2.1.1 Carrier Tape Dimension	11
2.1.2 Reel Dimension	11
2.1.3 Label Form Specification	12
2.2 Moisture Resistant Packing	12
2.3 Cardboard Box	13
2.4 Reliability Test Items And Conditions	13
2.5 Criteria For Judging Damage	14
3. SMT Reflow Soldering Instructions SMT	15
3.1 SMT Reflow Soldering Instructions SMT	15
4. Handling Precautions	17
4.1 Handling Precautions	17

1. Description

1.1 General Description

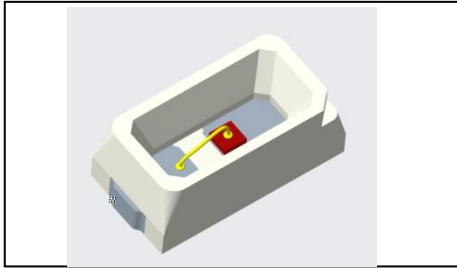

The Colour LED which was fabricated using a yellow-green chip Package Dimension : 1.6mmX0.8mmX0.55mm.

LED

1.6mmX0.8mmX0.55mm

1.2 Features

Extremely wide viewing angle.

Suitable for all SMT assembly and solder process.

Moisture sensitivity level: Level 3.

RoHS compliant.

RoHS

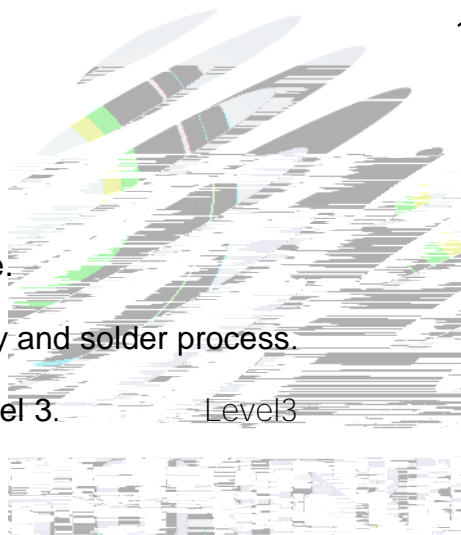

SMT

Level3

1.3 Application

Optical indicator.

Switch and symbol, display.

General use.

1.4 Package Dimension

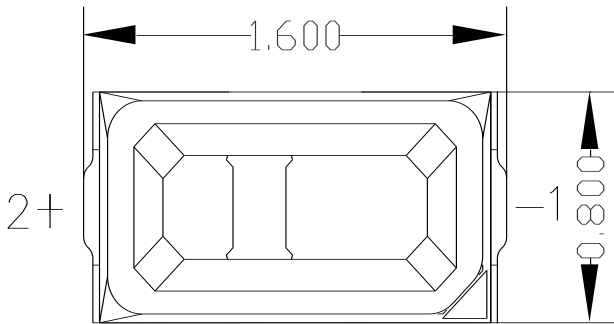

Fig.1-1 Top view

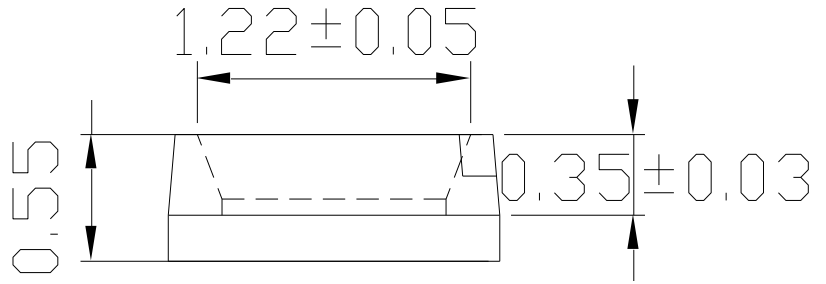

Fig.1-2 Side view

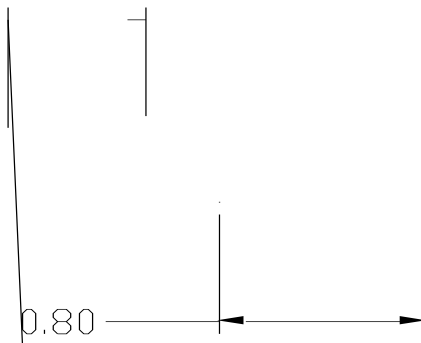

Fig.1-3 Bottom view

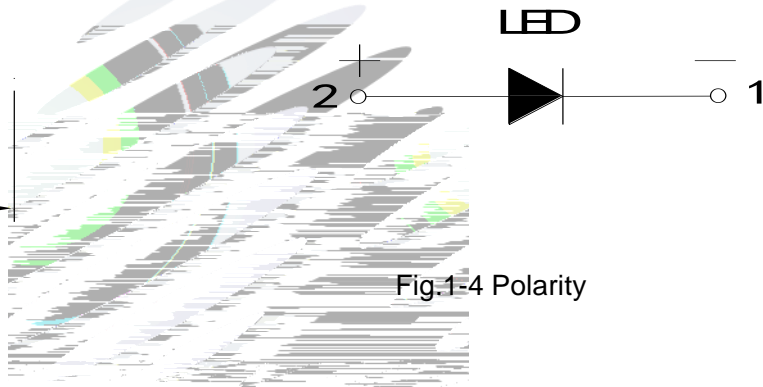

Fig.1-4 Polarity

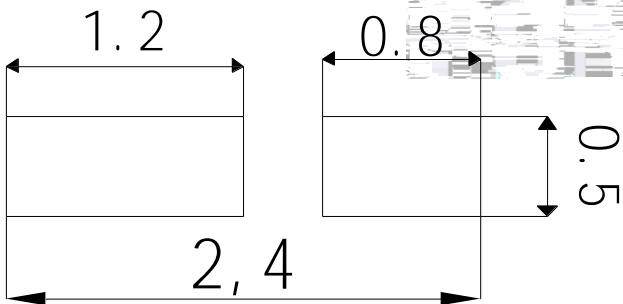

Fig.1-5 Soldering patterns

Notes

1. All dimensions units are millimeters.
2. All dimensions tolerances are ± 0.2 mm unless otherwise noted.

± 0.2

1.5 Product Parameters

Table 1-1 Electrical / Optical Characteristics at Ts=25°C

Item	Test Condition	Symbol	Value			Unit	
			Min. ()	Typ.	Max.		
Spectral Half Bandwidth	$I_F=20\text{mA}$		--	15	--	nm	
Forward Voltage	$I_F=20\text{mA}$	V_F	A1	1.6	--	1.7	V
			A2	1.7	--	1.8	V
			B1	1.8	--	1.9	V
			B2	1.9	--	2.0	V
			C1	2.0	--	2.1	V
			C2	2.1	--	2.2	V
			D1	2.2	--	2.3	V
			D2	2.3	--	2.4	V
Dominant Wavelength	$I_F=20\text{mA}$	λ_D	B10	565	--	567.5	nm
			B20	567.5	--	570	nm
			C10	570	--	572.5	nm
			C20	572.5	--	575	nm
Luminous Intensity	$I_F=20\text{mA}$	I_v	E00	43	--	65	mcd
			F00	65	--	100	mcd
			G00	100	--	150	mcd
			H00	150	--	230	mcd
			I00	230	--	350	mcd
Viewing Angle	$I_F=20\text{mA}$		--	120	--	deg	
Reverse Current	$V_R=5\text{V}$	I_R	--	--	10	A	
Thermal Resistance.	$I_F=20\text{mA}$	R_{THJ-S}	--	--	450	/W	

Notes : $V_R=5\text{V}$ For test conditions. $V_R=5\text{V}$

Table 1-2 Absolute Maximum Ratings at Ts=25°C

Parameter	Symbol	Rating	Units
Power Dissipation	P_d	72	mW
Forward Current	I_F	30	mA
Peak Forward Current Of Pulse	I_{FP}	60	mA
Electrostatic Discharge (HBM)	E_{SD}	2000	V
Operating Temperature	T_{opr}	-40 ~ +85	
Storage Temperature	T_{stg}	-40 ~ +85	
Junction Temperature	T_j	95	

Notes

- 1/10 Duty cycle, 0.1ms pulse width. 0.1ms, 1/10.
- The above forward voltage measurement allowance tolerance is $\pm 0.1V$. $\pm 0.1V$.
- The above dominant wavelength measurement allowance tolerance is $\pm 2nm$. $\pm 2nm$.
- The above luminous intensity measurement allowance tolerance $\pm 10\%$. $\pm 10\%$.
- Care is to be taken that power dissipation does not exceed the absolute maximum rating of the product.
- All measurements were made under the standardized environment of Refond.
- When the LEDs are in operation the maximum current should be decided after measuring the package temperature, junction temperature should not exceed the maximum rate. LED

1.6 Typical Optical Characteristics Curves

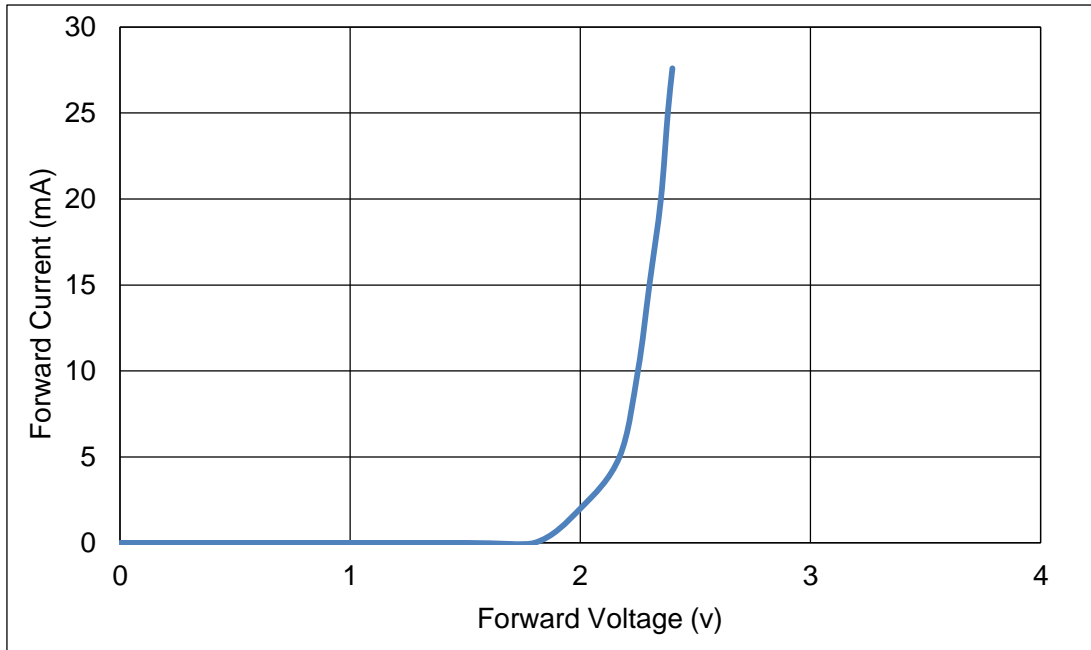

Fig 1-6 Forward Voltage Vs Forward Current

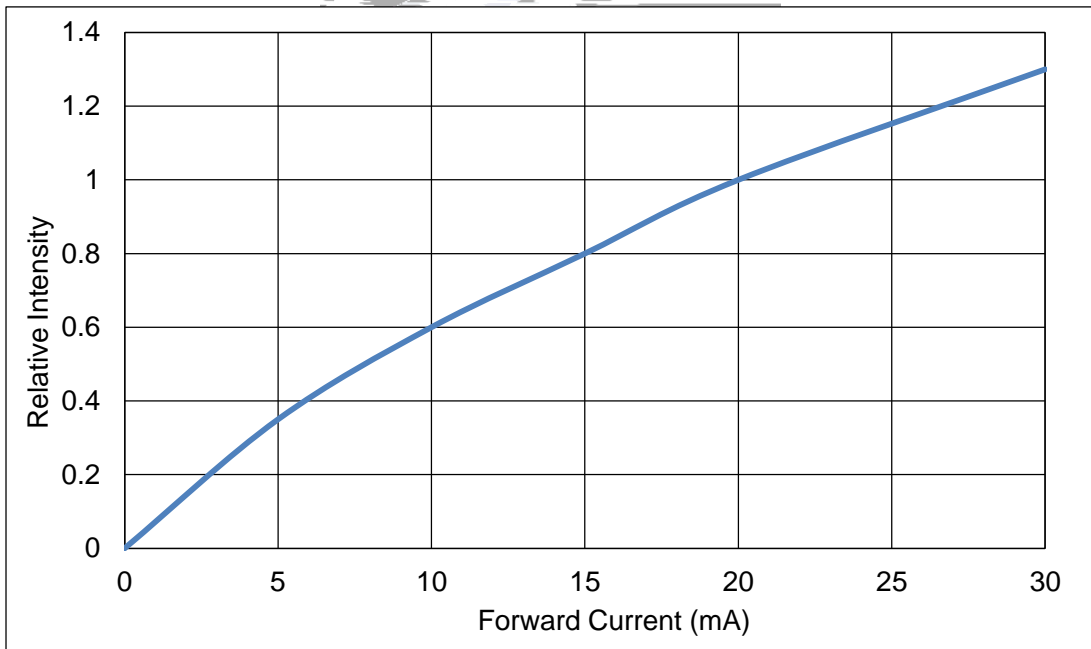

Fig 1-7 Forward Current Vs Relative Intensity

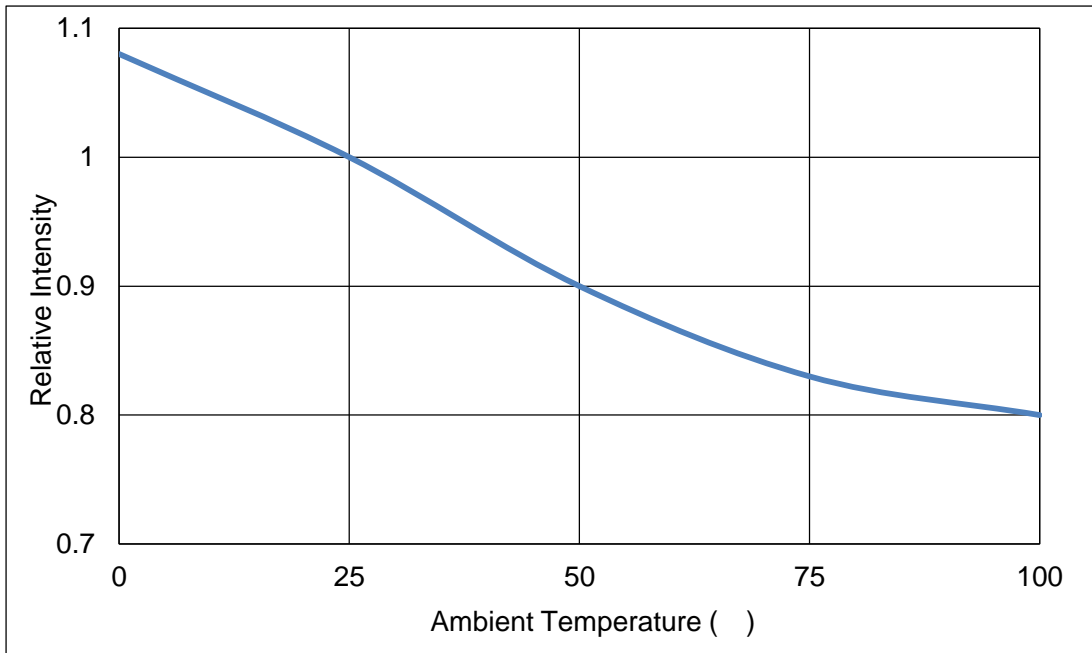

Fig 1-8 Pin Temperature Vs Relative Intensity

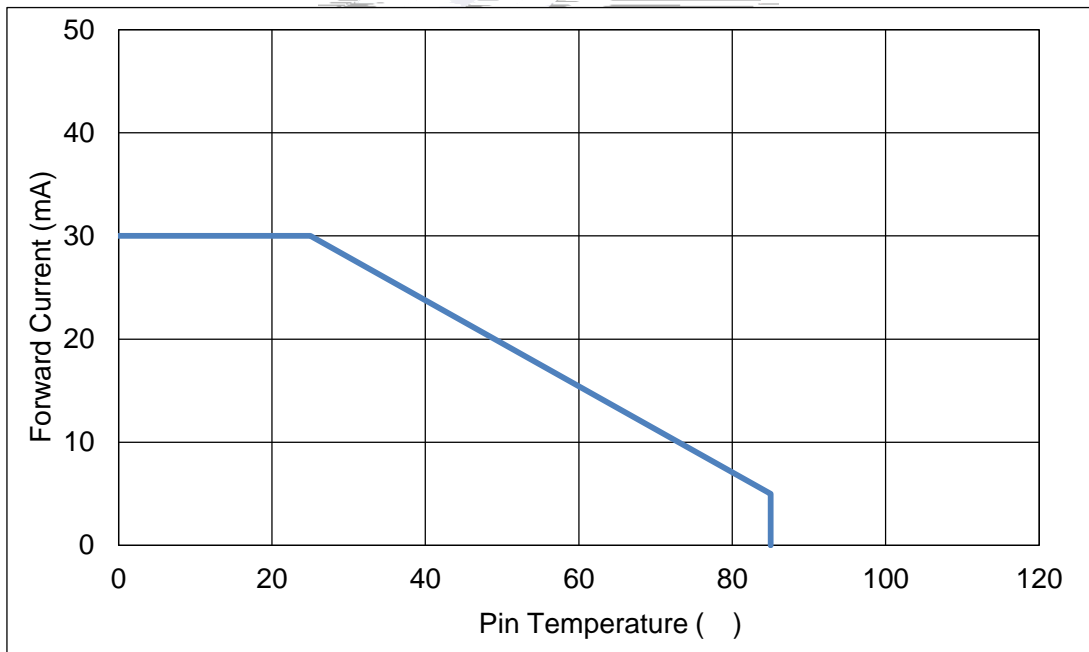
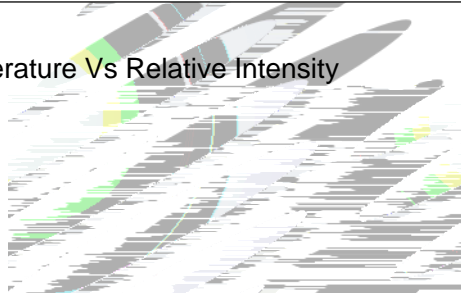

Fig 1-9 Pin Temperature Vs Forward Current

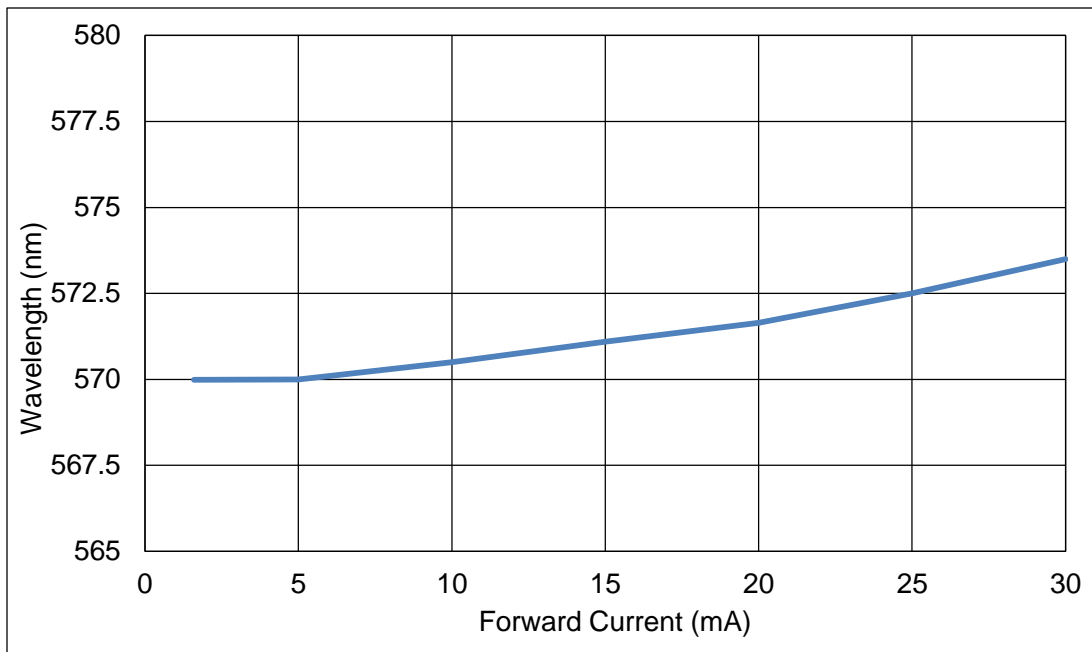

Fig 1-10 Forward Current Vs. Dominate Wavelength (Ta=25 °C)

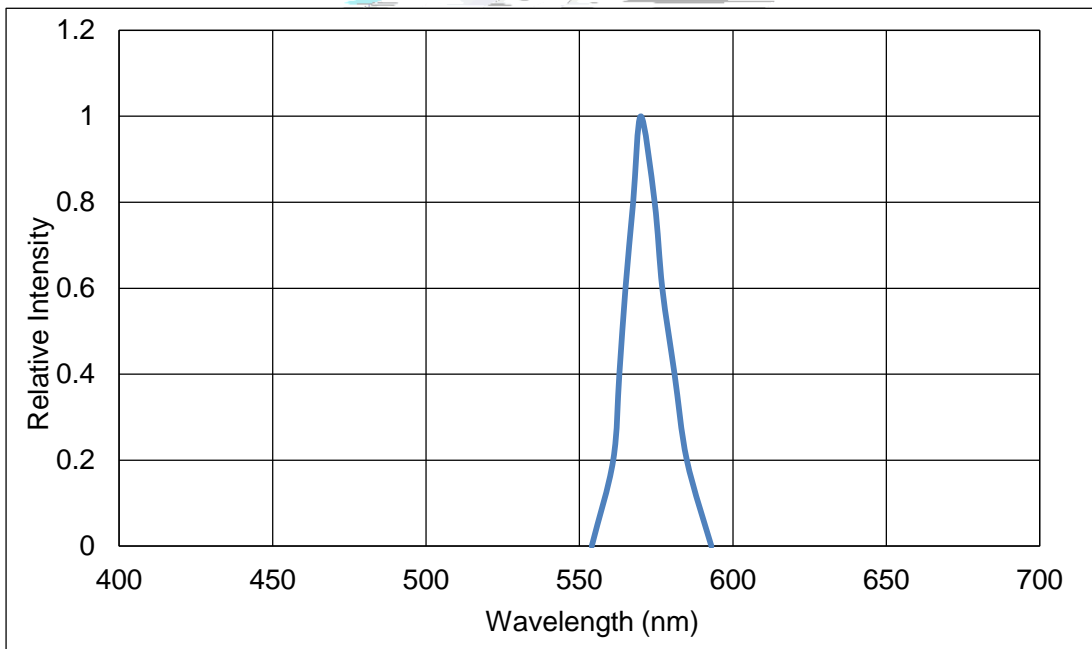
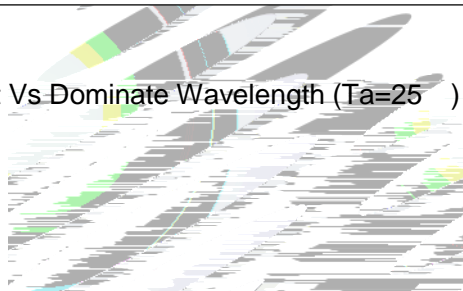

Fig 1-11 Relative Intensity Vs. Wavelength (Ta=25 °C)

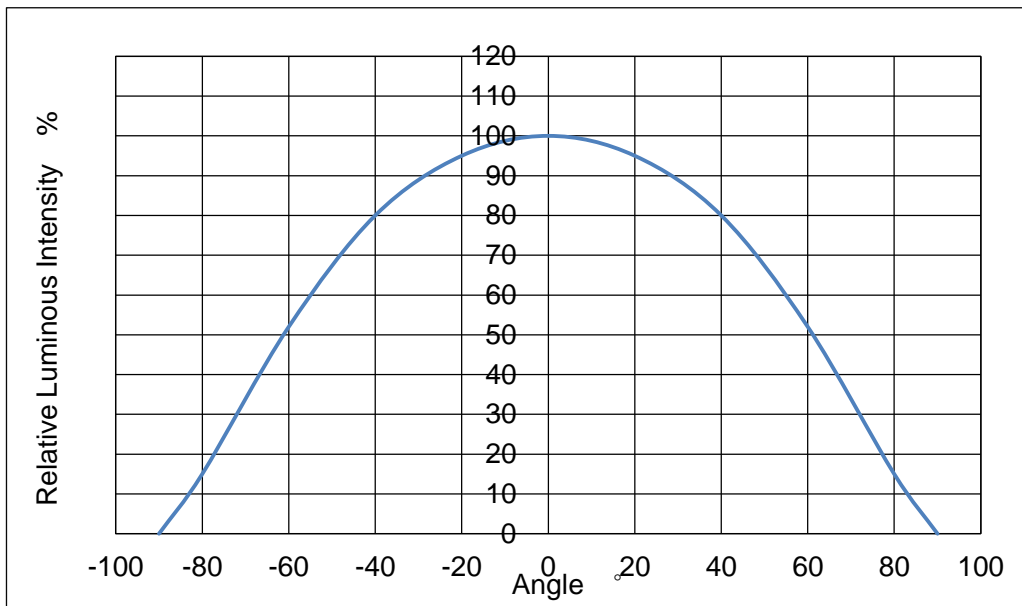
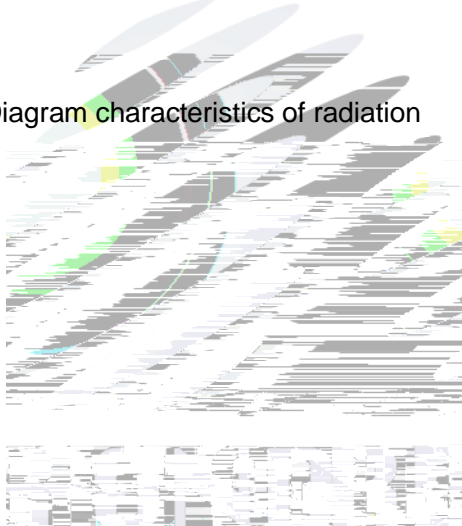

Fig 1-12 Diagram characteristics of radiation



2. Packaging

2.1 Packaging Specification

Package: 4000pcs/reel. 4000pcs

2.1.1 Carrier Tape Dimension

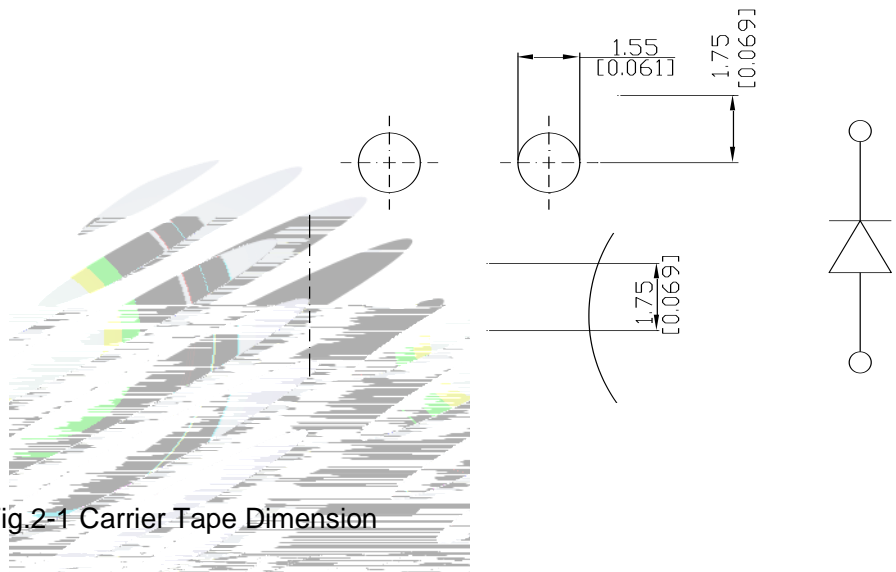

Fig.2-1 Carrier Tape Dimension

2.1.2 Reel Dimension

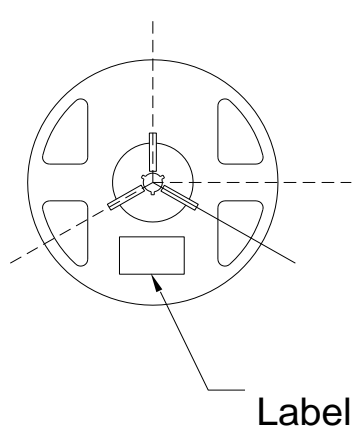

Fig.2-2 Reel Dimension

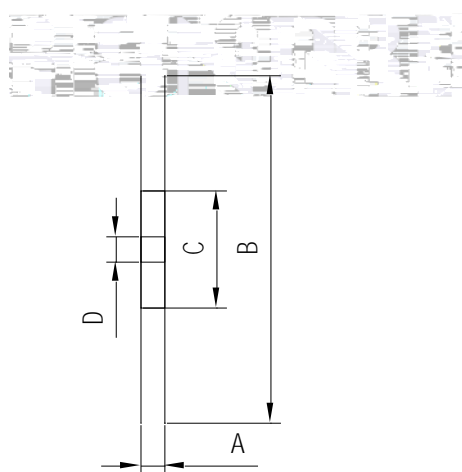

Table 2-1 Dimension

A	8.0±0.1mm
B	178±1mm
C	60±1mm
D	13.0±0.5mm

Notes

The tolerances unless mentioned ±0.1mm. Unit : mm

±0.1

2.1.3 Label Form Specification

Table 2-2 Parameter

PART NO.	Part Number
SPEC NO.	Spec Number
LOT NO.	Lot Number
BIN CODE	Bin Code
	Luminous flux
XY	Chromaticity Bin
V _F	Forward Voltage
WLD	Wavelength
QTY	Packing Quantity
DATE	Made Date



Fig. 2-3 Label Form Specification

2.2 Moisture Resistant Packing

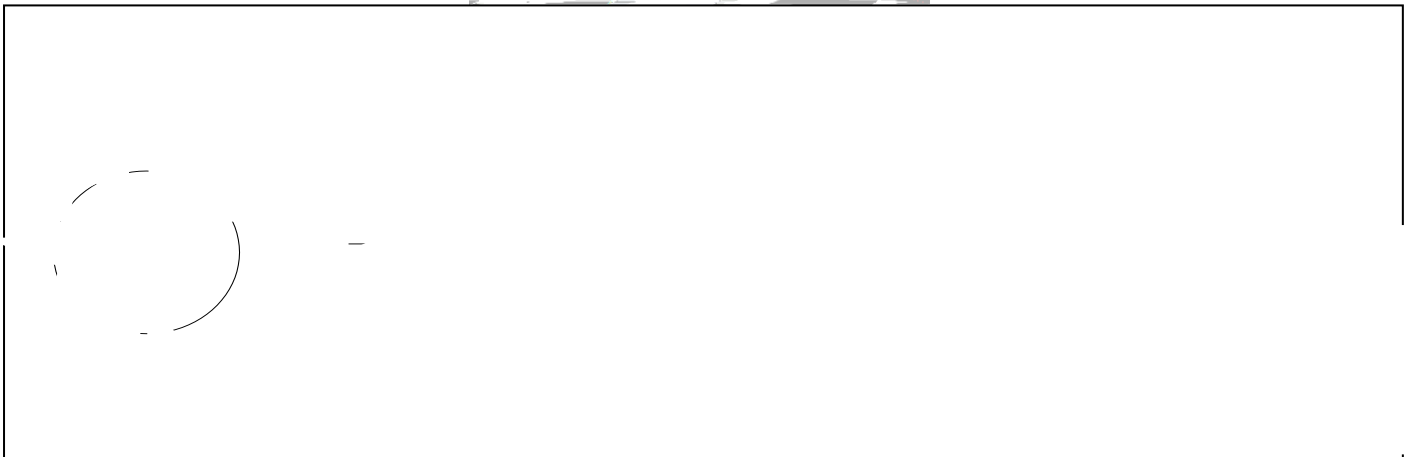
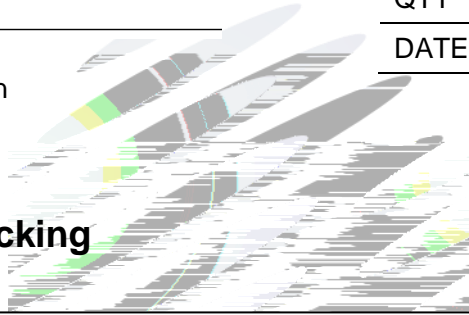

Fig.2-4 Moisture Resistant Packing

2.3 Cardboard Box

Fig.2-5 Cardboard Box

2.4 Reliability Test Items And Conditions

Table 2-3 Reliability Test Items And Conditions

Test Items	Ref.Standard	Test Condition	Time	Quantity	Ac/Re /
Reflow	JESD22-B106	Temp:260 max T=10 sec	2 times	22Pcs.	0/1
Temperature Cycle	JESD22-A104	100 30 min 5 min -40 30 min	100 cycles	22Pcs.	0/1
Thermal Shock	JESD22-A106	-40 15min 100 15min	300 cycles	22Pcs.	0/1
High Temperature Storage	JESD22-A103	Temp:100	1000 hrs.	22Pcs.	0/1
Low Temperature Storage	JESD22-A119	Temp:-40	1000 hrs.	ef*47.64 2	

2.5 Criteria For Judging Damage

Table 2-4 Criteria For Judging Damage

Test Items	Symbol	Test Condition	Criteria For Judgement	
			Min.	Max.
Forward Voltage	V_F	$I_F=20\text{mA}$	-	U.S.L*)x1.1
Reverse Current	I_R	$V_R= 5\text{V}$	-	U.S.L*)x2.0
Luminous Flux		$I_F=20\text{mA}$	L.S.L*)x0.7	-

Notes

1.U.S.L: Upper standard level

L.S.L: Lower standard level

2.The above reliability tests is based on the verification of a single/strip LED of Refond's existing experimental platform,the reliability experiment was taken under good heat dissipation conditions. When customers applies the LED to the series and parallel circuit,should take consideration of all the factors such as the current, voltage distribution, heat dissipation and others.

LED

3.The technical information shown in the data sheets is limited to the typical characteristics and circuit examples of the referenced products. It does not constitute the warranting of industrial property nor the granting of any license.

3. SMT Reflow Soldering Instructions SMT

3.1 SMT Reflow Soldering Instructions SMT

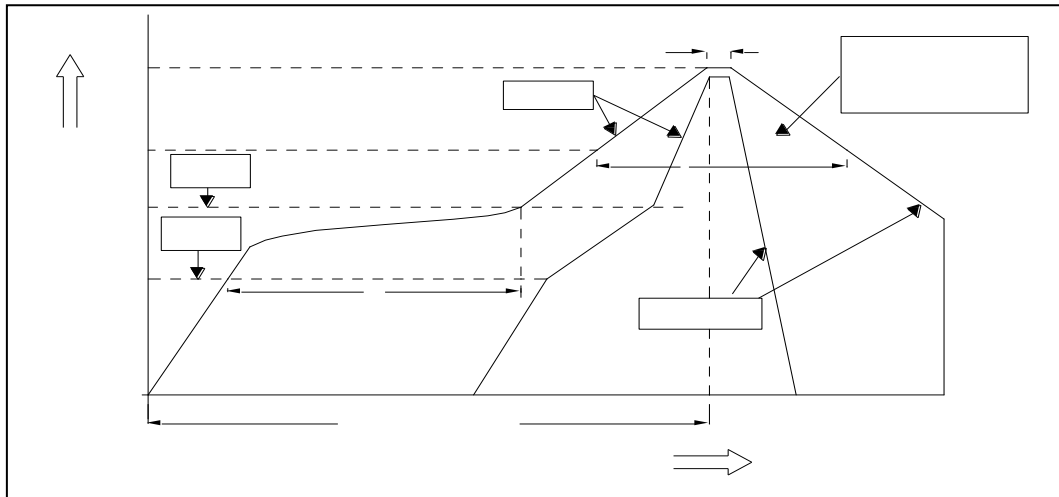

Fig.3-1 SMT Reflow Soldering Instructions SMT

Table 3-1 Parameter

Average temperature rise speed	T_{smax} T_P	3 °C/ Max 3 °C/ s
Preheating: minimum temperature	(T_{smin})	150 °C
Preheating: Max temperature	(T_{smax})	200 °C
Preheating: Time	T_{smin} T_{smax}	60 - 120 60s-120s
Time limited to maintain high temperature: the temperature	(T_L)	217 °C
Time limited to maintain high temperature: The Time	(t_L)	60 - 150 60s-150s
Peak /Classification of temperature:	(T_P)	260 °C
Time limit classification of peak temperature time	t_p	10 Max 10s
Hold time within 5 °C with the actual peak temperature (TP)	(T_P)	30 Max 30s
5 °C		
Cooling speed		6 °C/ Max 6 °C/ s
Needed time from 25 °C to T_p	25 °C	8 Max 8 minutes

Notes

(1)Reflow soldering should not be done more than twice. If more than 24 hours between the two solderings , LED will be damaged. 24 LED

(2)When soldering , do not put stress on the LEDs during heating.

3.1.1 Soldering Iron

(1) When do soldering by hand, keep the temperature of iron bel7 10.5 Tc[do)]TJ0.66 Tm[)]0.56 Tfg6.8

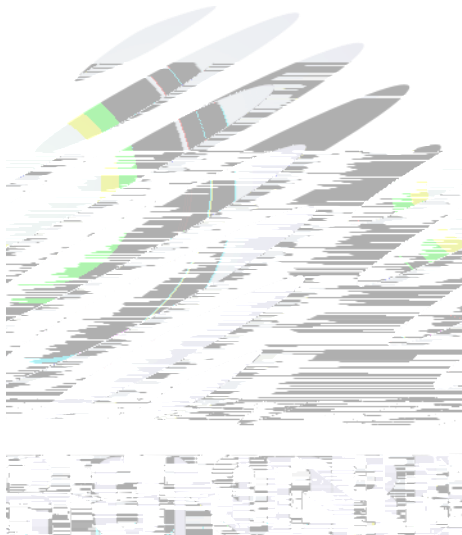

4. Handling Precautions

4.1 Handling Precautions

(1) LED operating environment and sulfur element composition cannot be over 100PPM in the LED mating usage material. This is provided for informational purposes only and is not a warranty or endorsement. LED 100PPM.

(2) In order to prevent external material from getting into the inside of LED, which may cause the malfunction of LED, the single content of Bromine element is required to be less than 900PPM, the single content of Chlorine element is required to be less than 900PPM, the total content of Bromine element and Chlorine element in the external materials of the application products is required to be less than 1500PPM. This is provided for informational purposes only and is not a warranty or endorsement.



(3) VOCs (Volatile organic compounds) emitted from materials used in the construction of fixtures can penetrate silicone encapsulants of LEDs and discolor when exposed to heat and photonic energy. The result can be a significant loss of light output from the fixture. Knowledge of the properties of the materials selected to be used in the construction of fixtures can help prevent these issues. Refond advises against the use of any chemicals or materials that have been found or are suspected to have an adverse effect on device performance or reliability. To verify compatibility, Refond recommends that all chemicals and materials be tested in the specific application and environment for which they are intended to be used. Attaching LEDs, do not use adhesives that outgas organic vapor. LED

LED

LED

LED

(4) In designing a circuit, the current through each LED can not exceed the absolute maximum rating specified for each LED. In the meanwhile, resistors for protection should be applied, otherwise slight voltage shift will cause big current change, burn out may happen. The driving circuit must be designed to allow forward voltage only when it is ON or OFF. If the reverse voltage is applied to LED, migration can be generated resulting in LED damage. LED

LED

(5) Thermal Design is paramount importance because heat generation may result in the Characteristics decline, such as brightness decreased, Color change and so on. Please consider the heat generation of the LEDs when making the system design. LED

LED

(6) Storage

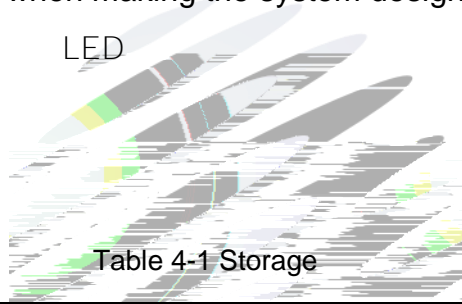

Table 4-1 Storage

Conditions		Temperature	Humidity	Time
Storage	Before Opening Aluminum Bag	30	75%	Within 1 Year From Date
	After Opening Aluminum Bag	30	60%	168hours 168
Baking		60±5	-	24hours 24

(7) If the moisture absorbent material (silica gel) has faded away or the LEDs have exceeded the storage time , baking treatment should be performed after unpacking and based on the following condition (60±5) °C for above 24 hours.

60±5 24

If the package is flatulence or damaged, please notify the sales staff to assist.

(8) Similar to most Solid state devices; LEDs are sensitive to Electro-Static Discharge (ESD) and Electrical Over Stress (EOS). LED

(9) Other points for attention, please refer to our relevant information.

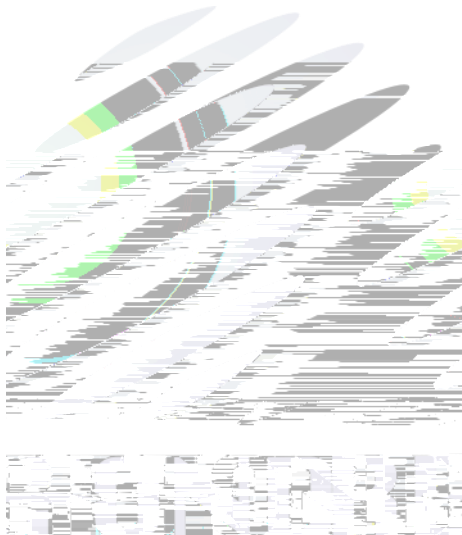

Version History/

Date	Revisor	Version	Verifier	Remarks
2019.09.17		E0		





Declare

This specification is written both in English and in Chinese and the latter is formal.