

SPECIFICATION

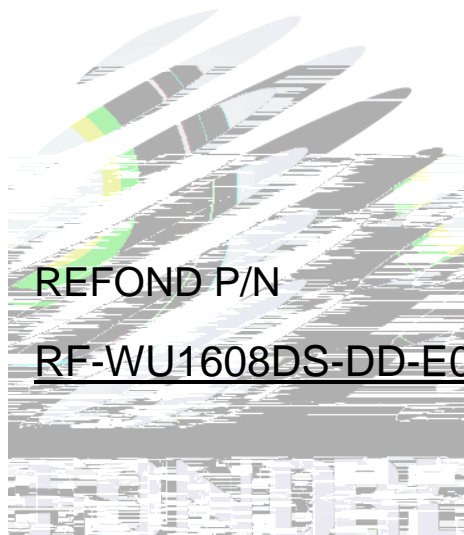

REFOND P/N

RF-WU1608DS-DD-E0

Mass Product



Contents

1. Description	
1.1 General Description	
1.2 Features	
1.3 Application	
1.4 Package Dimension	
1.5 Product Parameters	
1.6 Bin Range Of Forward Voltage and Luminous Flux (IF=20mA)	BIN
(IF=20mA)	
1.7 Typical Optical Characteristics Curves	
2. Packaging	
2.1 Packaging Specification	
2.1.1 Carrier Tape Dimension	12
2.1.2 Reel Dimension	12
2.1.3 Label Form Specification	13
2.2 Moisture Resistant Packing	
2.3 Cardboard Box	
2.4 Reliability Test Items And Conditions	
2.5 Criteria For Judging Damage	
3. SMT Reflow Soldering Instructions SMT	
3.1 SMT Reflow Soldering Instructions SMT	
4. Handling Precautions	
4.1 Handling Precautions	

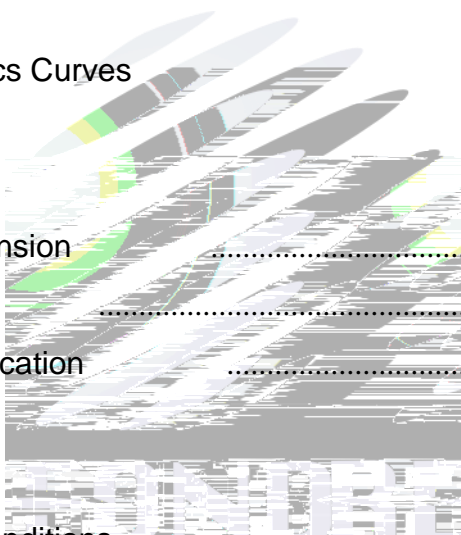

1. Description

1.1 General Description

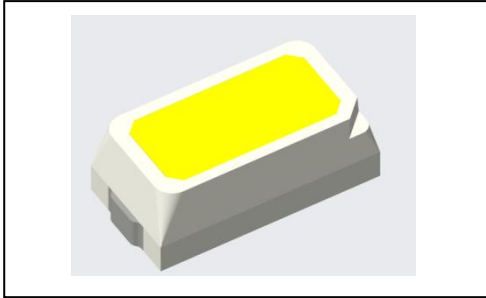

The White LED, which was fabricated by using a blue chip and the phosphor.

Product Package:1.6mmX0.8mmX0.55mm.

1.2 Features

Extremely wide viewing angle.

Suitable for all SMT assembly and solder process.

Moisture sensitivity level: Level 3. Level 3

RoHS compliant. RoHS

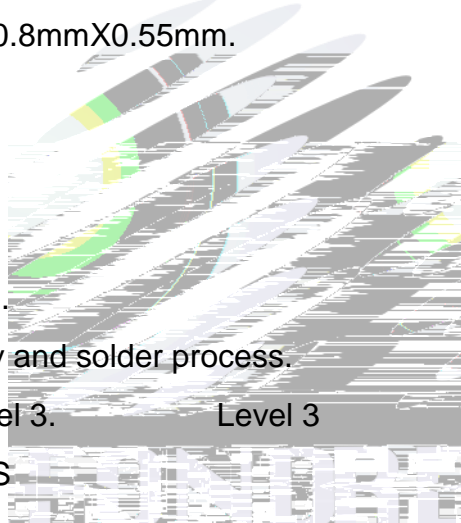

SMT

1.3 Application

Optical indicator.

Switch and Symbol, Display.

Household electrical appliances .

General use.



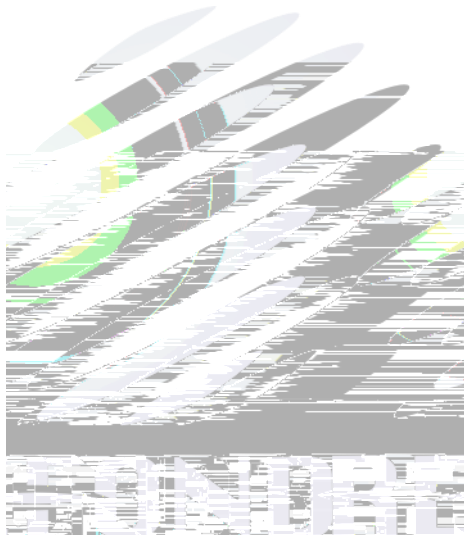

1.5 Product Parameters

Table 1-1 Electrical / Optical Characteristics at Ts=25°C

Item	Test Condition	Symbol		Value			Unit
				Min.	Typ. ()	Max. ()	
Forward Voltage	I _F =20mA	V _F	F1	2.6	--	2.7	V
			F2	2.7	--	2.8	V
			G1	2.8	--	2.9	V
			G2	2.9	--	3.0	V
			H1	3.0	--	3.1	V
			H2	3.1	--	3.2	V
			I1	3.2	--	3.3	V
Luminous Intensity	I _F =20mA	I _v	L20	1000	--	1200	mcd
			M10	1200	--	1500	mcd
			M20	1500	--	1800	mcd
			N10	1800	--	2300	mcd
			N20	2300	--	2800	mcd
			O10	2800	--	3500	mcd
Viewing Angle	I _F =20mA		--	120	--	deg	
Reverse Current	V _R =5V/10ms	I _R	--	--	10	A	
Thermal Resistance.	I _F =20mA	R _{THJ-S}	--	--	450	/W	

 Notes : V_R=5V For test conditions. V_R=5V

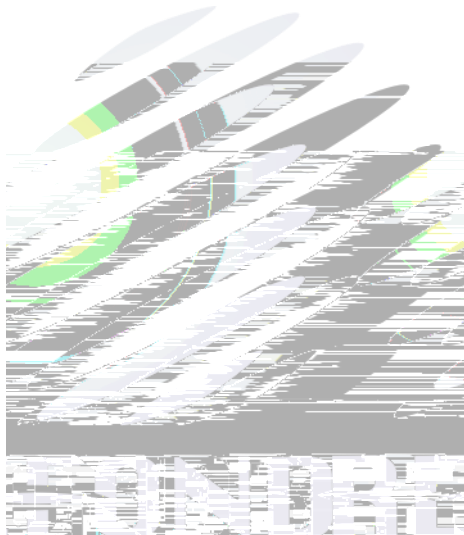
1.6 Bin Range Of Forward Voltage and Luminous Flux (IF=20mA)

BIN (IF=20mA)

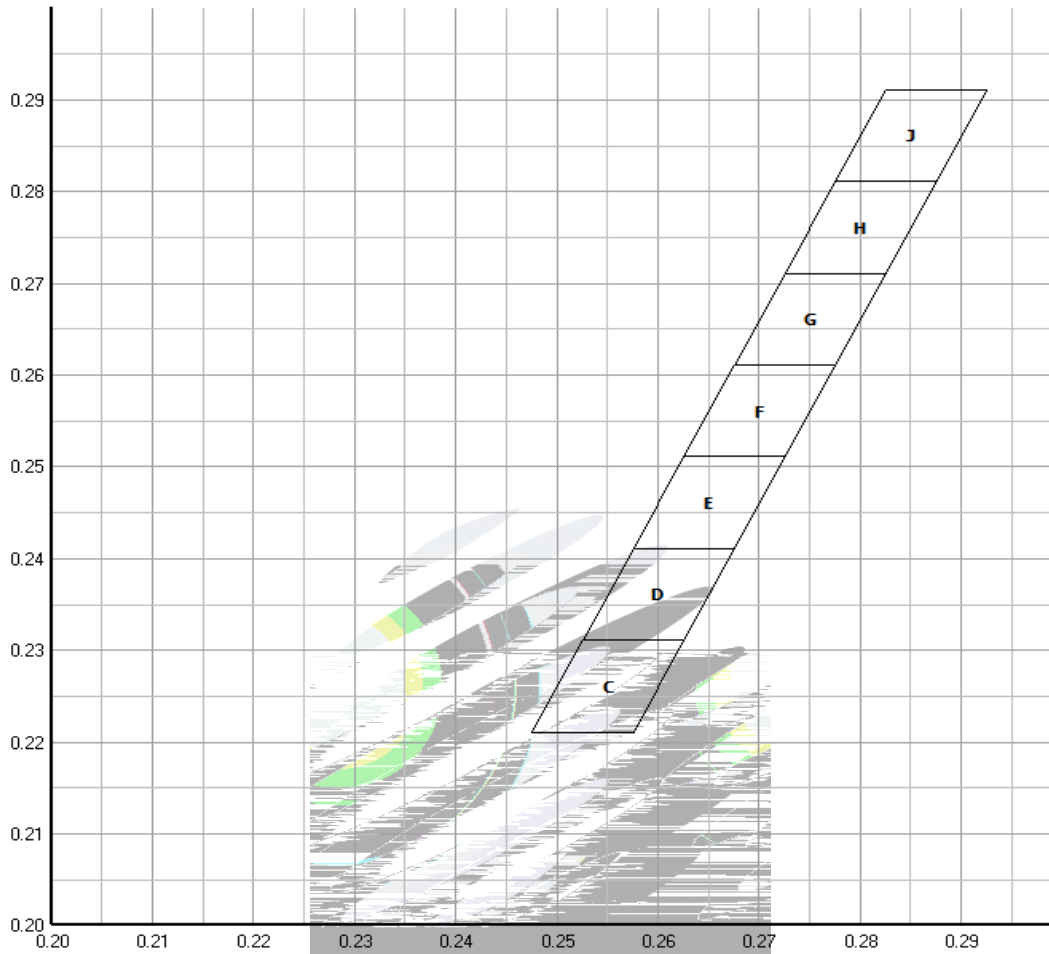

Fig. 1-6 The C.I.E Chromaticity Diagram CIE

Table 1-3 Bin Date Bin



1.7 Typical Optical Characteristics Curves

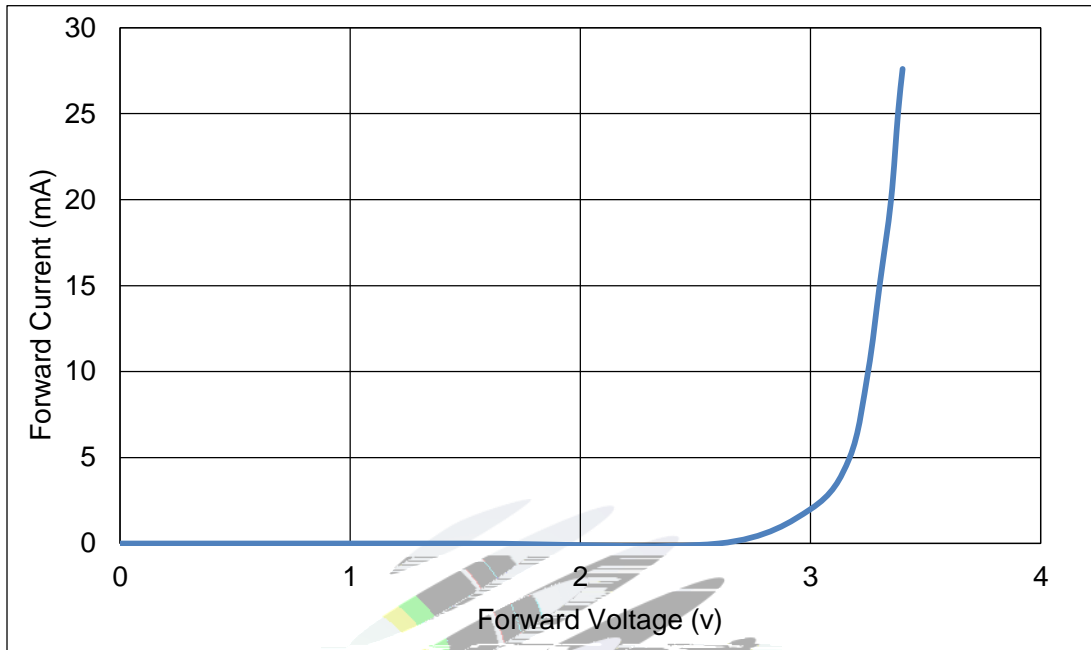

Fig. 1-7 Forward Voltage Vs Forward Current

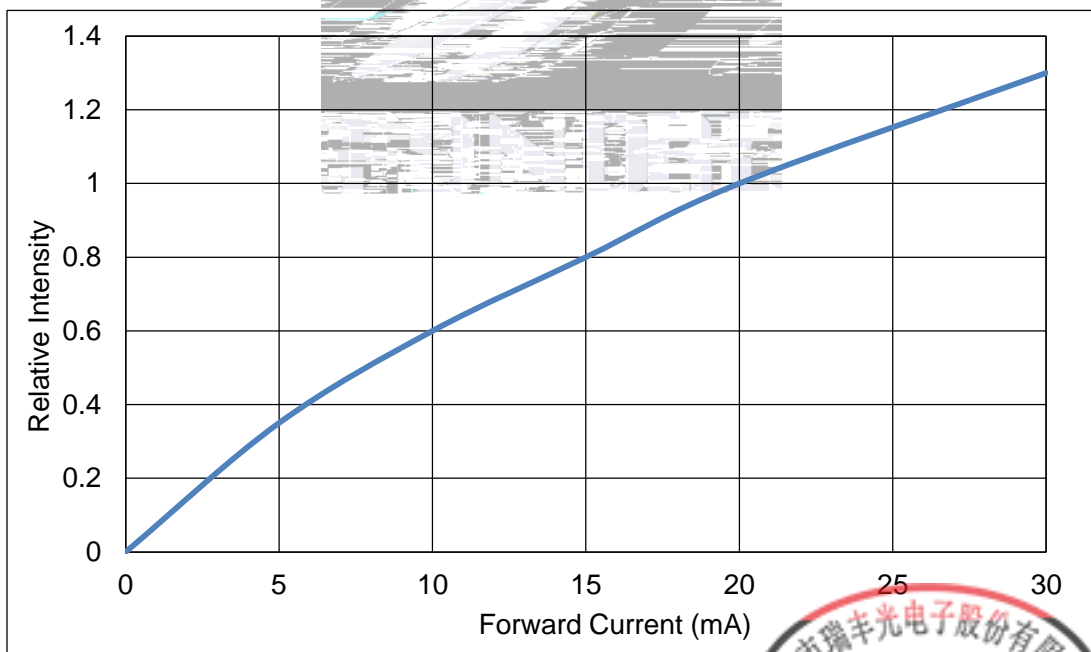
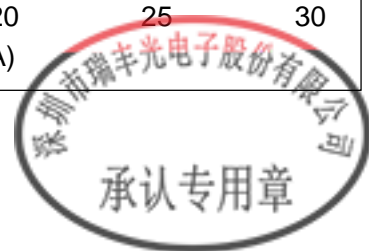

Fig. 1-8 Forward Current Vs Relative Intensity



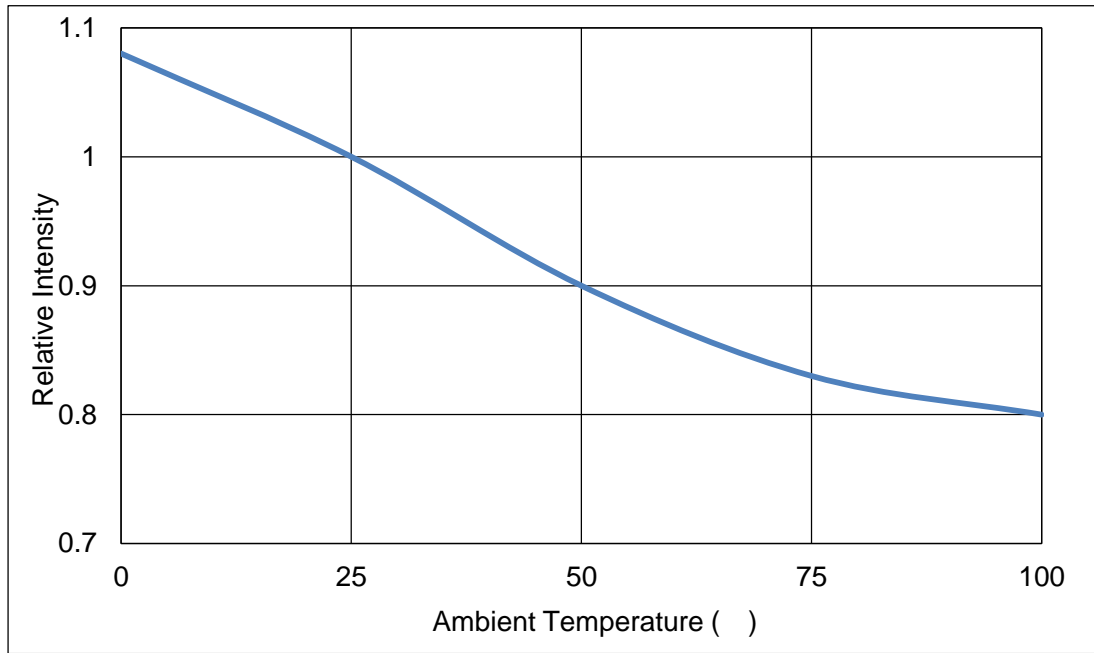

Fig. 1-9 Pin Temperature Vs Relative Intensity

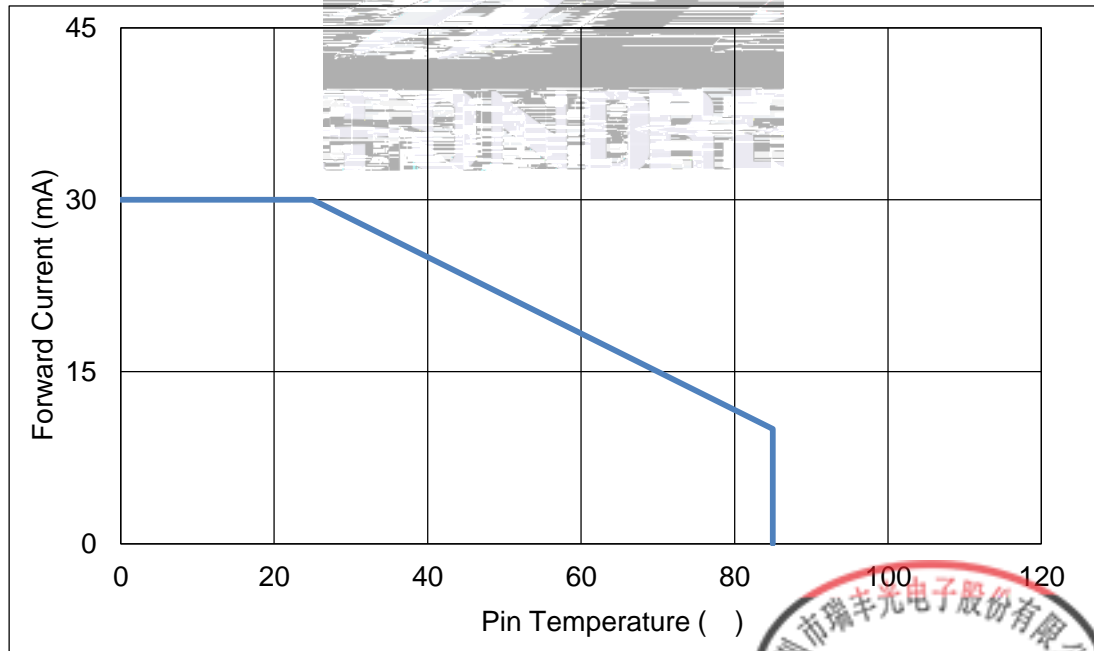
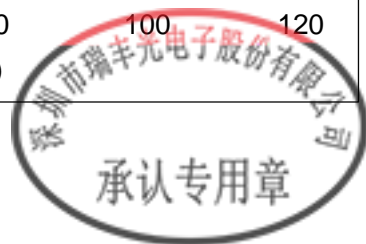

Fig. 1-10 Pin Temperature Vs Forward Current



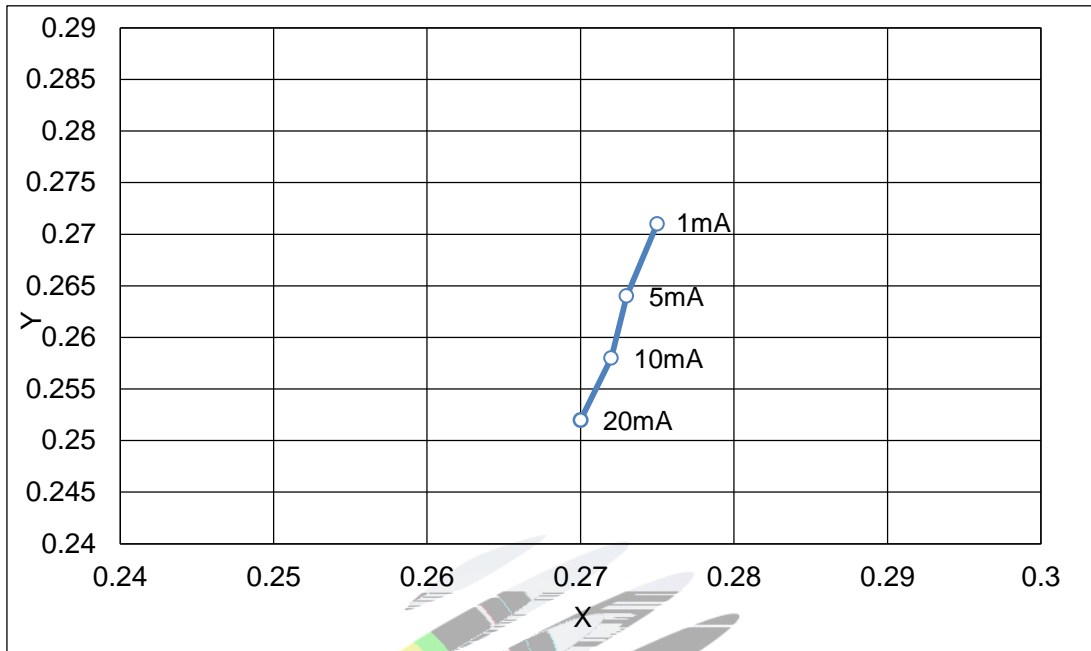

Fig. 1-11 Forward Current Vs Dominant Wavelength (Ta=25)

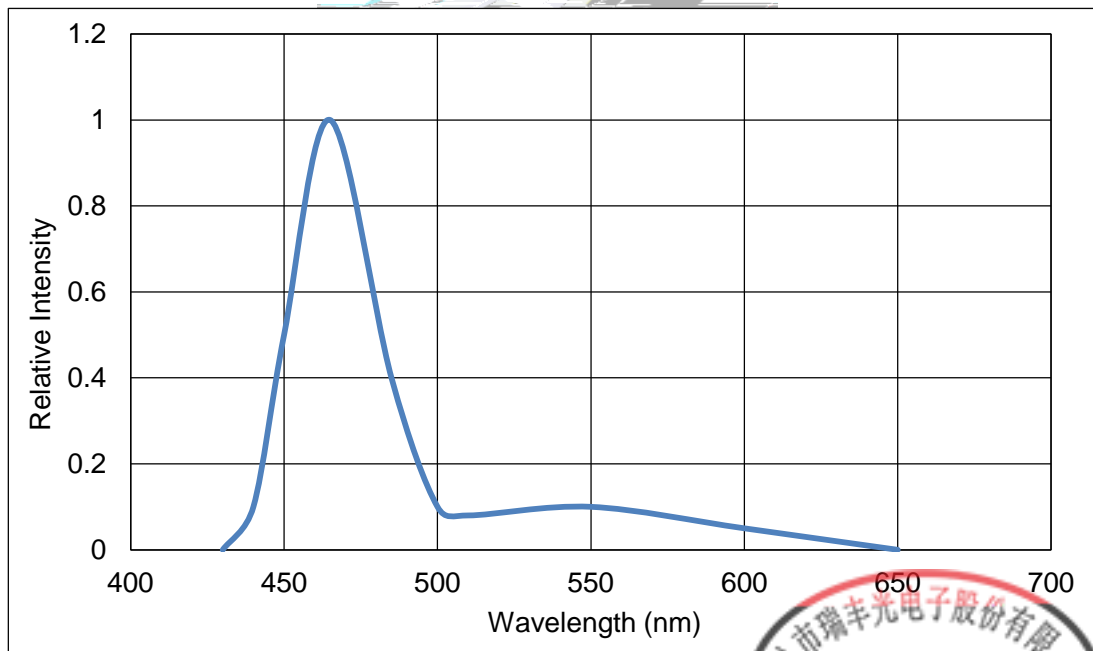
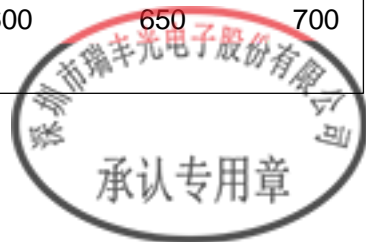

Fig. 1-12 Relative Intensity Vs Wavelength (Ta=25)



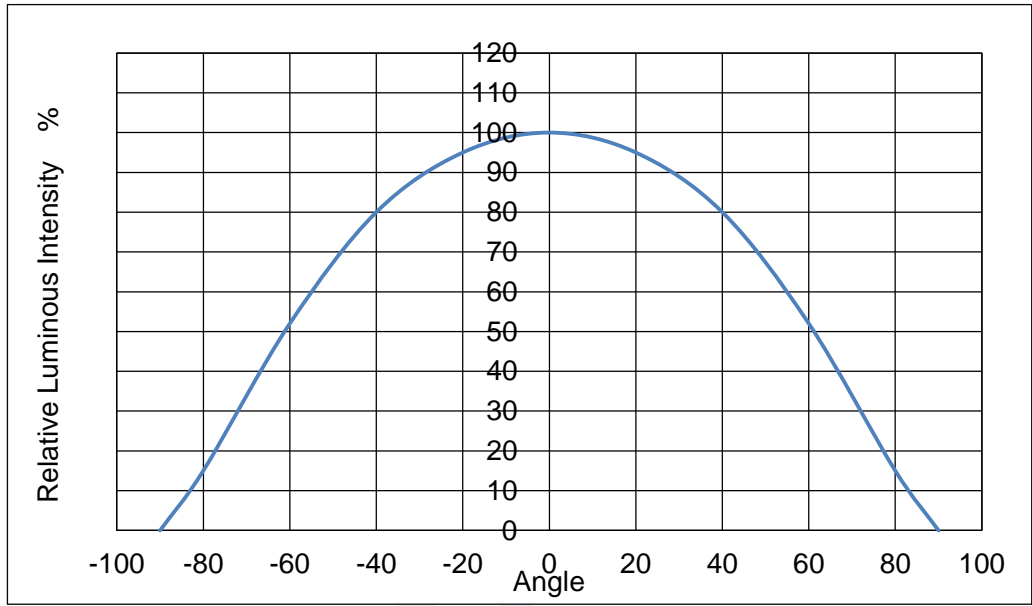
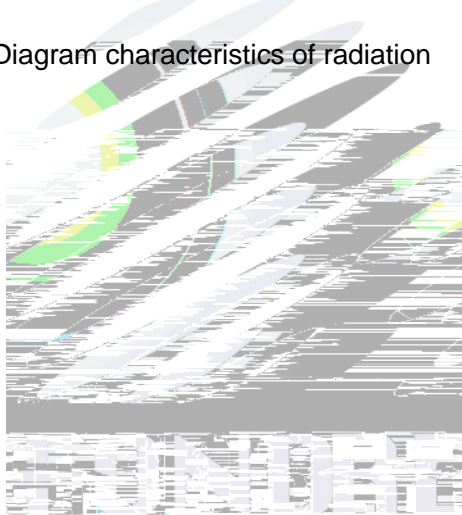

Fig. 1-13 Diagram characteristics of radiation



2. Packaging

2.1 Packaging Specification

Package: 4000pcs/reel. 4000pcs

2.1.1 Carrier Tape Dimension

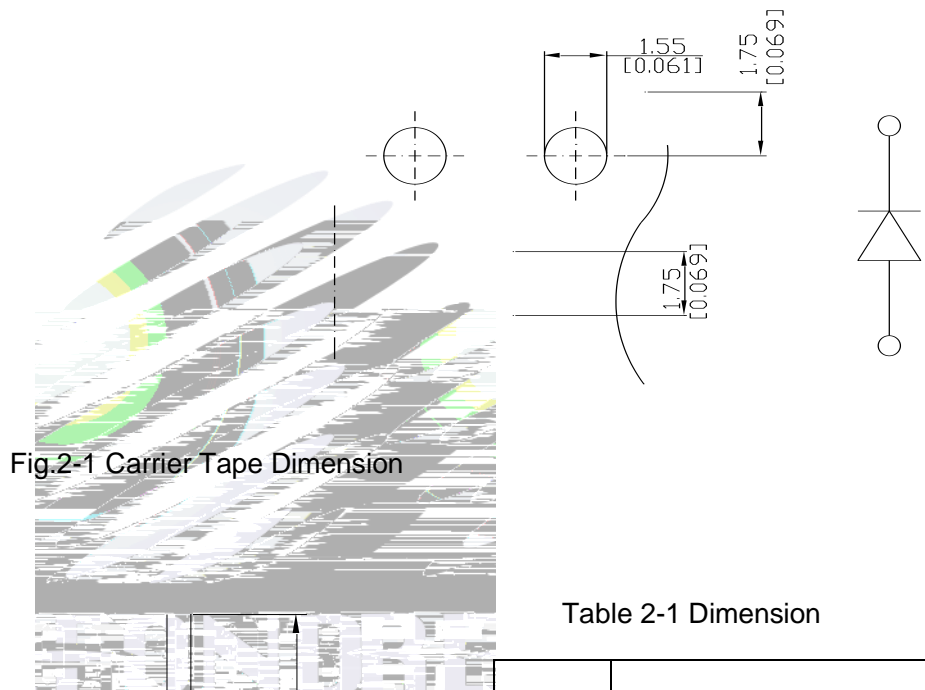

Fig.2-1 Carrier Tape Dimension

2.1.2 Reel Dimension

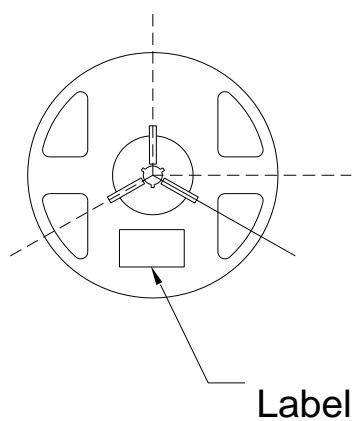

Fig.2-2 Reel Dimension

Table 2-1 Dimension

A	8.0 0.1mm
B	178 1mm
C	60 1mm
D	13.0 0.5mm

Notes

The tolerances unless mentioned $\pm 0.1\text{mm}$. Unit : mm



2.1.3 Label Form Specification



PART NO:		
SPEC NO:		
LOT NO		
BIN CODE:		
Φ:	XY:	
VF:	WLD:	
		
		QTY:
		DATE:

Table 2-2 Parameter

PART NO.	Part Number
SPEC NO.	Spec Number
LOT NO.	Lot Number
BIN CODE	Bin Code
	Luminous flux
XY	Chromaticity Bin
V _F	Forward Voltage
WLD	Wavelength
QTY	Packing Quantity
DATE	Made Date

Fig. 2-3 Label Form Specification

2.2 Moisture Resistant Packing

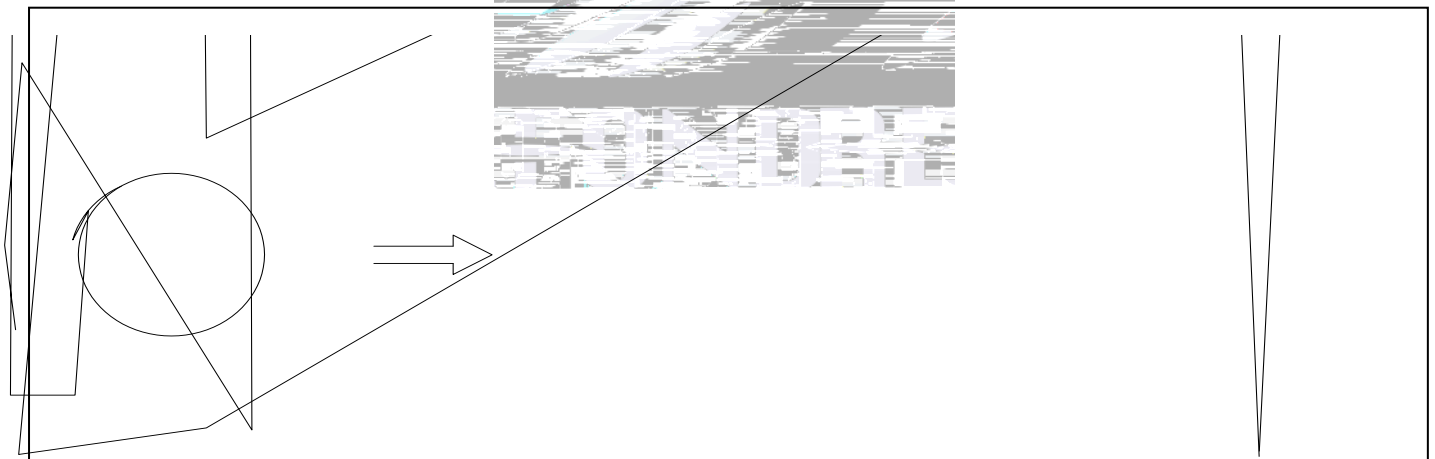

Fig.2-4 Moisture Resistant Packing



2.3 Cardboard Box

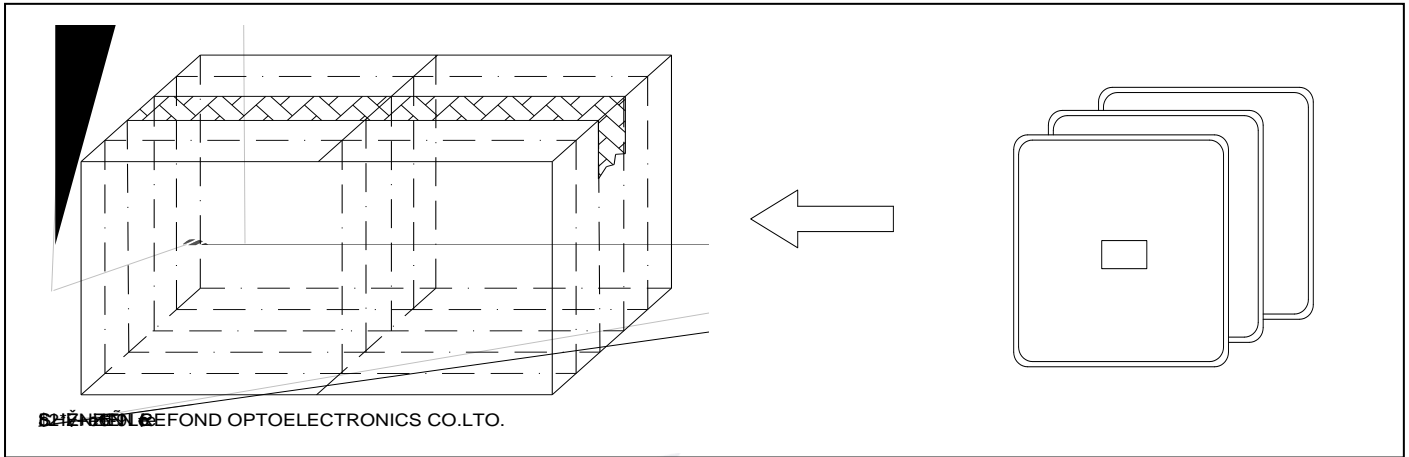
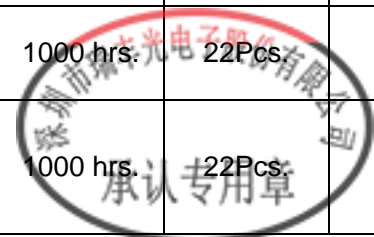

Fig.2-5 Cardboard Box

2.4 Reliability Test Items And Conditions

Table 2-3 Reliability Test Items And Conditions

Test Items	Ref.Standard	Test Condition	Time	Quantity	Ac/Re /
Reflow	JESD22-B106	Temp:260 max T=10 sec	2 times	22Pcs.	0/1
Temperature Cycle	JESD22-A104	100 30 min 5 min -40 30 min	100 cycles	22Pcs.	0/1
Thermal Shock	JESD22-A106	-40 15min 100 15min	300 cycles	22Pcs.	0/1
High Temperature Storage	JESD22-A103	T _{emp} :100	1000 hrs.	22Pcs.	0/1
Low Temperature Storage	JESD22-A119	T _{emp} :-40	1000 hrs.	22Pcs.	0/1
Life Test	JESD22-A108	T _a =25 I _F =20mA	1000 hrs.	22Pcs.	0/1



2.5 Criteria For Judging Damage

Table 2-4 Criteria For Judging Damage

Test Items	Symbol	Test Condition	Criteria For Judgement	
				Max.
Forward Voltage	V_F	$I_F=20\text{mA}$	-	U.S.L*)x1.1
Reverse Current	I_R	$V_R= 5\text{V}$	-	U.S.L*)x2.0
Luminous Flux		$I_F=20\text{mA}$	L.S.L*)x0.7	-

Notes

1.U.S.L: Upper standard level

L.S.L: Lower standard level

2.The above reliability tests is based on the verification of a single/strip LED of Refond's existing experimental platform,the reliability experiment was taken under good heat dissipation conditions. When customers applies the LED to the series and parallel circuit,should take consideration of all the factors such as the current, voltage distribution, heat dissipation and others.

3.The technical information shown in the data sheets is limited to the typical characteristics and circuit examples of the referenced products. It does not constitute the warranting of industrial property nor the granting of any license.



3. SMT Reflow Soldering Instructions SMT

3.1 SMT Reflow Soldering Instructions SMT

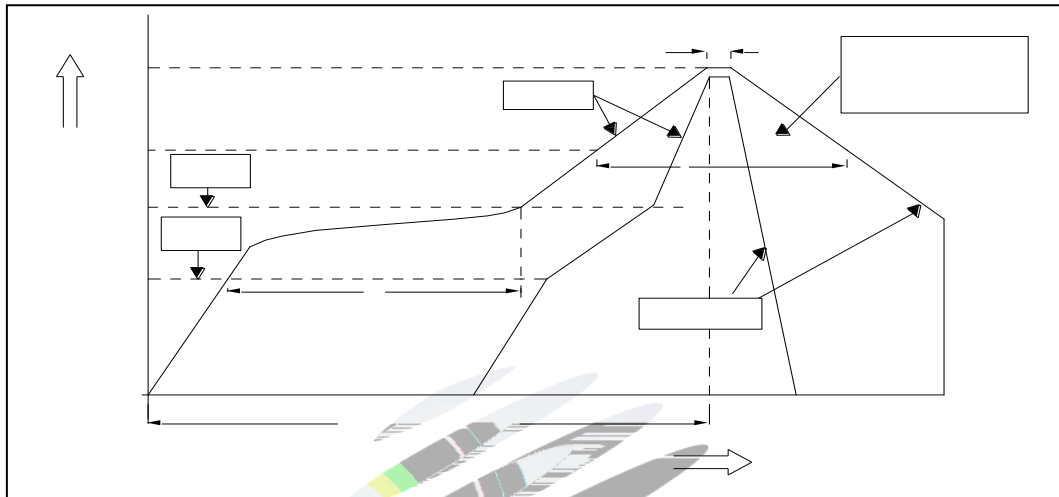
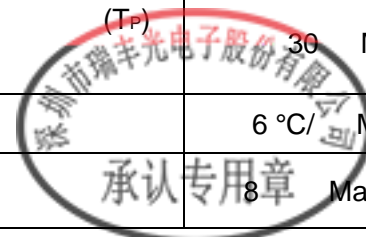

Fig.3-1 SMT Reflow Soldering Instructions SMT

Table 3-1 Parameter

Average temperature rise speed	T_{smx} T_p	3 °C/ Max 3 °C/ s
Preheating: minimum temperature	(T_{smin})	150 °C
Preheating: Max temperature	(T_{smx})	200 °C
Preheating: Time	T_{smin} T_{smx}	60 - 120 60s-120s
Time limited to maintain high temperature: the temperature	(T_l)	217 °C
Time limited to maintain high temperature: The Time	(t_l)	60 - 150 60s-150s
Peak /Classification of temperature:	/ (T_p)	260 °C
Time limit classification of peak temperature time	t_p	10 Max 10s
Hold time within 5 °C with the actual peak temperature (T_p)	(T_p)	30 Max 30s
Cooling speed		6 °C/ Max 6 °C/ s
Needed time from 25 °C to T_p	25 °C	8 Max 8 minutes



Notes

(1)Reflow soldering should not be done more than twice. If more than 24 hours between the two solderings , LED will be damaged.

(2)Whensoldering , do not put stress on the LEDs during heating.

3.1.1 Soldering Iron

(1) When do soldering by hand, keep the temperature of iron below less 300°C less than 3 seconds

(2) Soldering by hand should be done only one time.

3.1.2 Repairing

Repairing should not be done after the LEDs have been soldered. When repairing is unavoidable,a double-head soldering iron should be used (as below figure). It should be confirmed in advance whether the characteristics of LEDs will or not be damaged by repairing.

LED

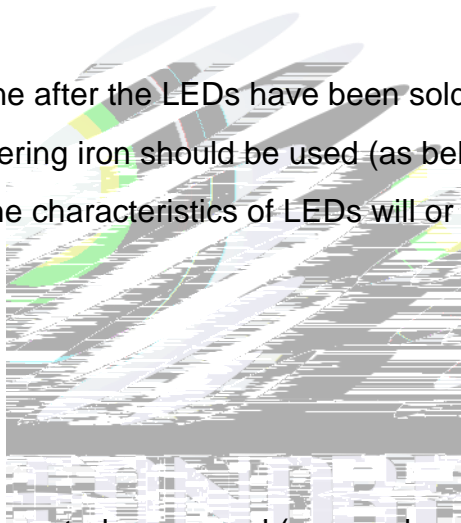

3.1.3 Cautions

(1) Components should not be mounted on-warped (non coplanar) portion of PCB. After soldering, do not warp the circuit board.LED

(2) Do not apply mechanical force or excess vibration during the cooling process to normal temperature after soldering. Do not rapidly cool device after soldering.



4. Handling Precautions

4.1 Handling Precautions

(1) LED operating environment and sulfur element composition cannot be over 100PPM in the LED mating usage material. This is provided for informational purposes only and is not a warranty or endorsement. LED

(2) In order to prevent external material from getting into the inside of LED, which may cause the malfunction of LED, the single content of Bromine element is required to be less than 900PPM, the single content of Chlorine element is required to be less than 900PPM, the total content of Bromine element and Chlorine element in the external materials of the application products is required to be less than 1500PPM. This is provided for informational purposes only and is not a warranty or endorsement.

(3) VOCs (Volatile organic compounds) emitted from materials used in the construction of fixtures can penetrate silicone encapsulants of LEDs and discolor when exposed to heat and photonic energy. The result can be a significant loss of light output from the fixture. Knowledge of the properties of the materials selected to be used in the construction of fixtures can help prevent these issues. Refond advises against the use of any chemicals or materials that have been found or are suspected to have an adverse effect on device performance or reliability. To verify compatibility, Refond recommends that all chemicals and materials be tested in the specific application and environment for which they are intended to be used. Attaching LEDs, do not use adhesives that outgas organic vapor.



(4) In designing a circuit, the current through each LED can not exceed the absolute maximum rating specified for each LED. In the meanwhile, resistors for protection should be applied, otherwise slight voltage shift will cause big current change, burn out may happen. The driving circuit must be designed to allow forward voltage only when it is ON or OFF. If the reverse voltage is applied to LED, migration can be generated resulting in LED damage.

(5) Thermal Design is paramount importance because heat generation may result in the Characteristics decline, such as brightness decreased, Color change and so on. Please consider the heat generation of the LEDs when making the system design. LED

(6) Storage

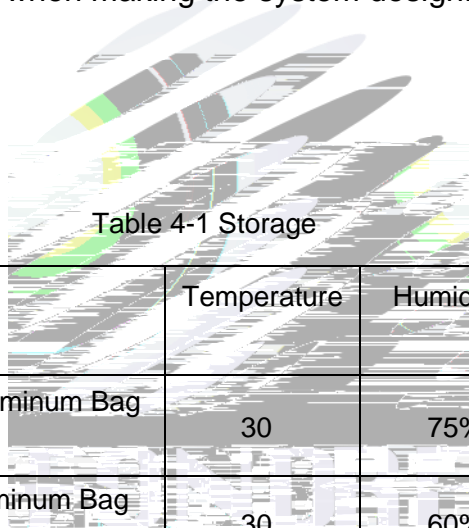

Table 4-1 Storage

Conditions		Temperature	Humidity	Time
Storage	Before Opening Aluminum Bag	30	75%	Within 1 Year From Date
	After Opening Aluminum Bag	30	60%	168hours 168
Baking		60 5	-	24hours 24

(7) I



(8) Similar to most Solid state devices; LEDs are sensitive to Electro-Static Discharge (ESD) and Electrical Over Stress (EOS).

(9) Other points for attention, please refer to our relevant information.

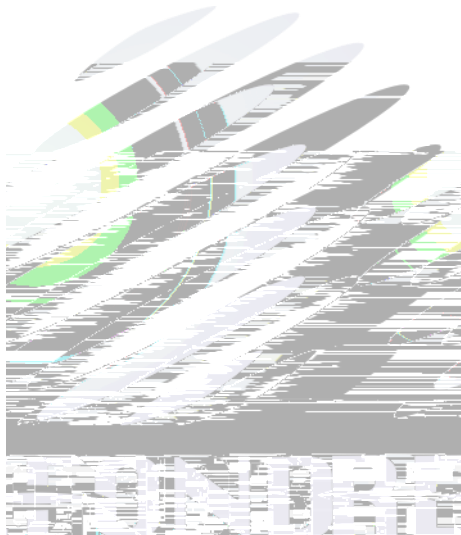



Declare

This specification is written both in English and in Chinese and the latter is formal.

