

±

						μ

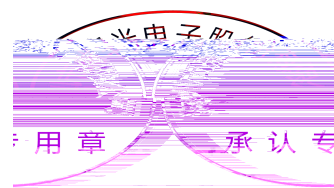

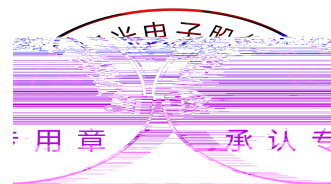

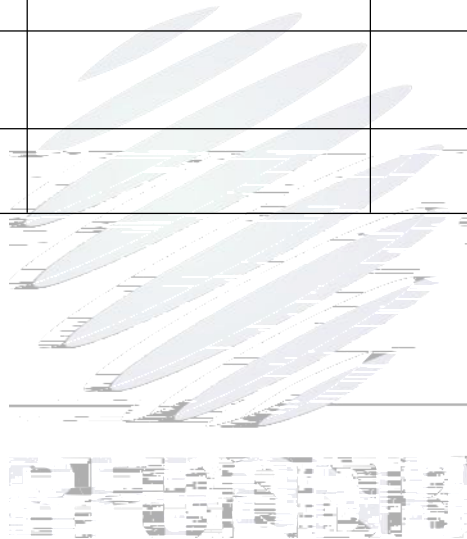
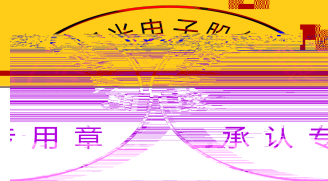
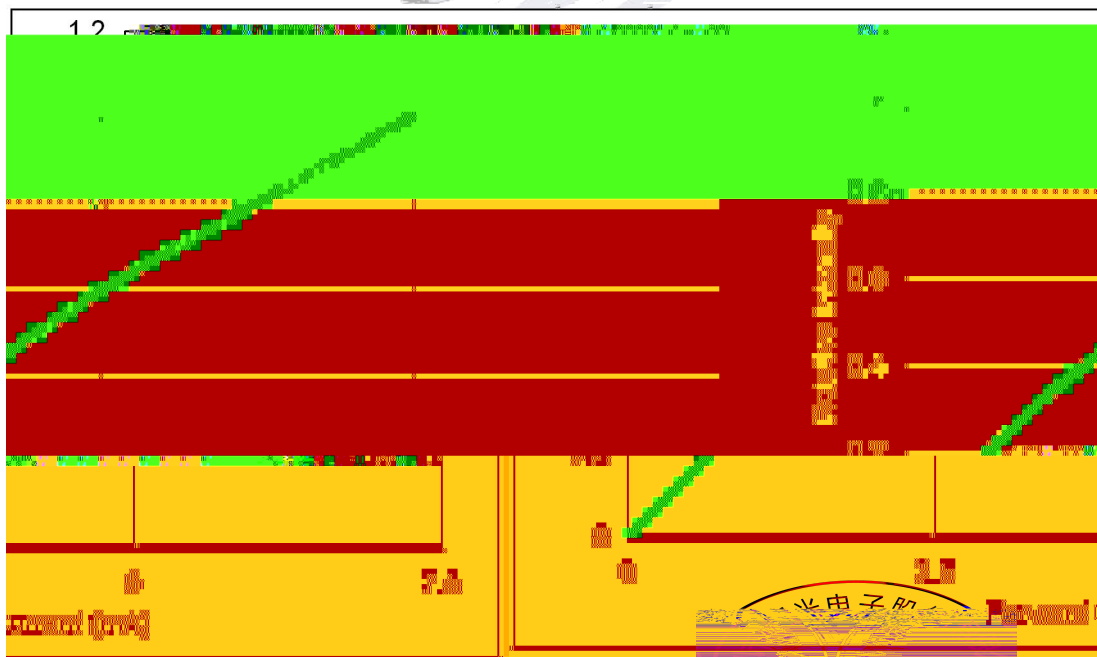

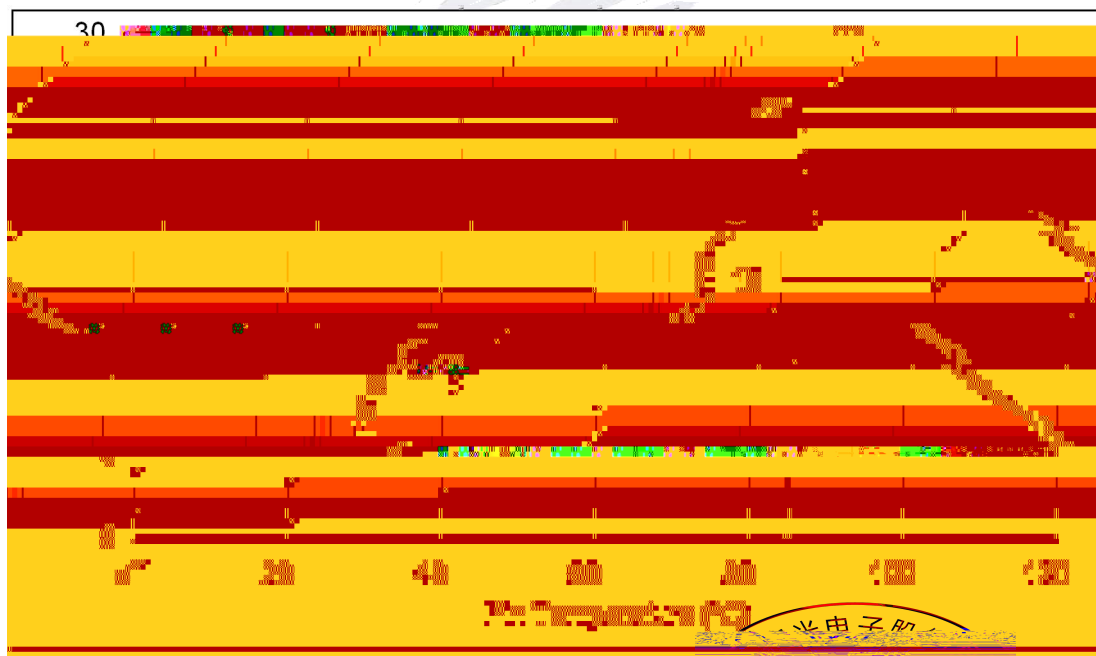
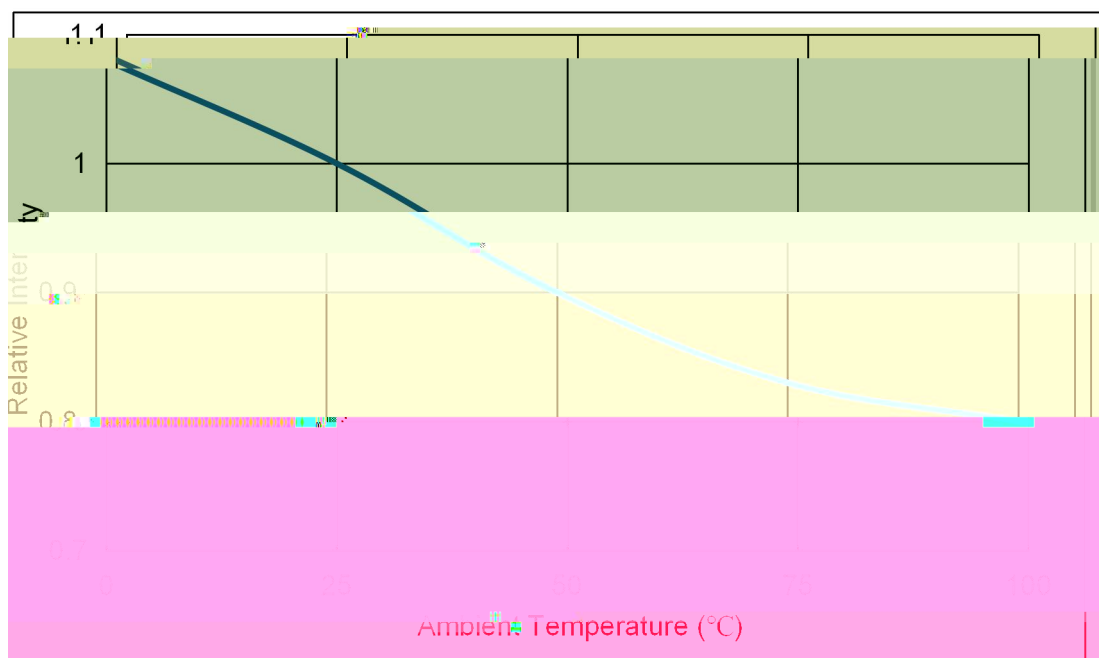

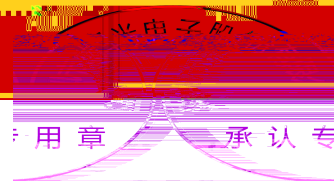
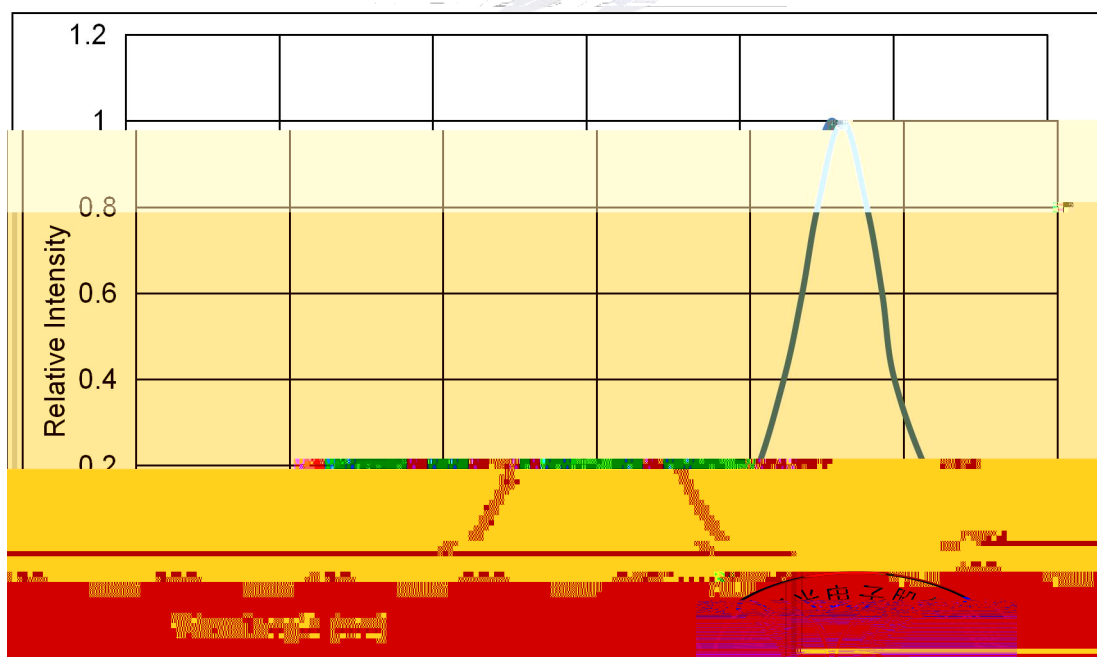
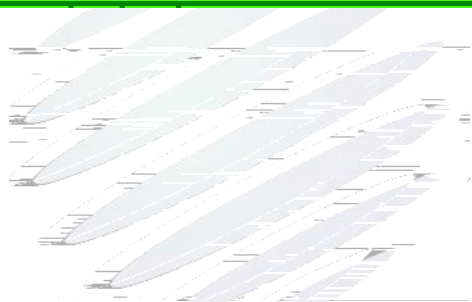
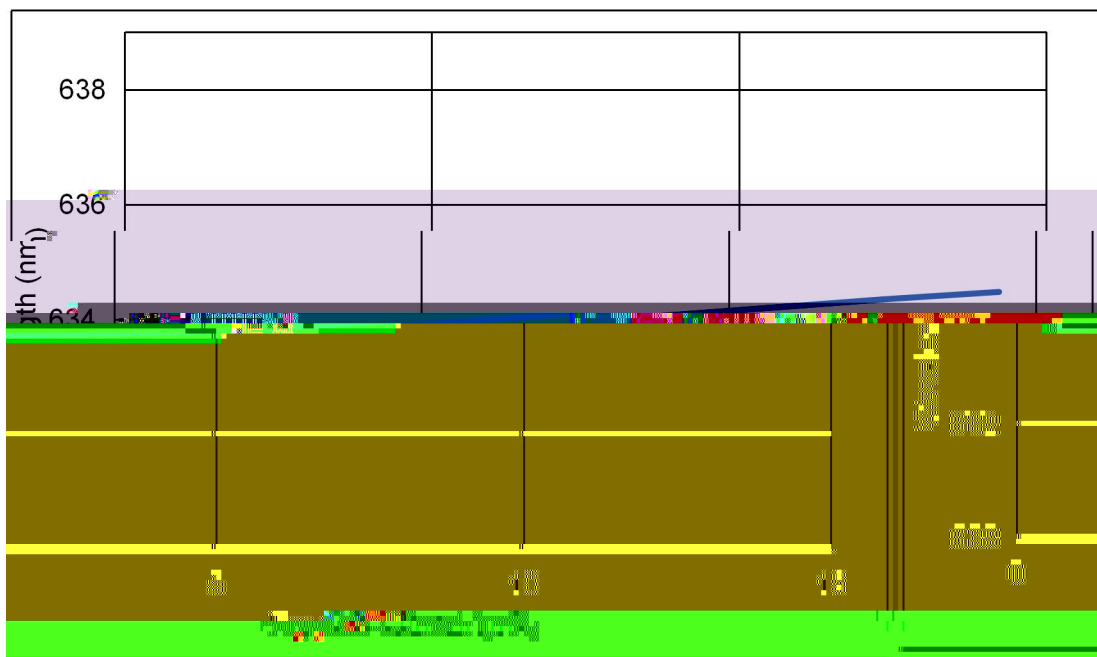

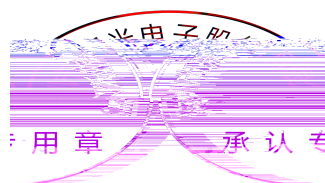
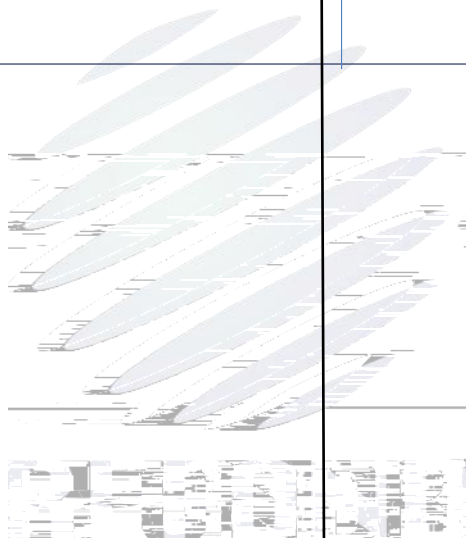
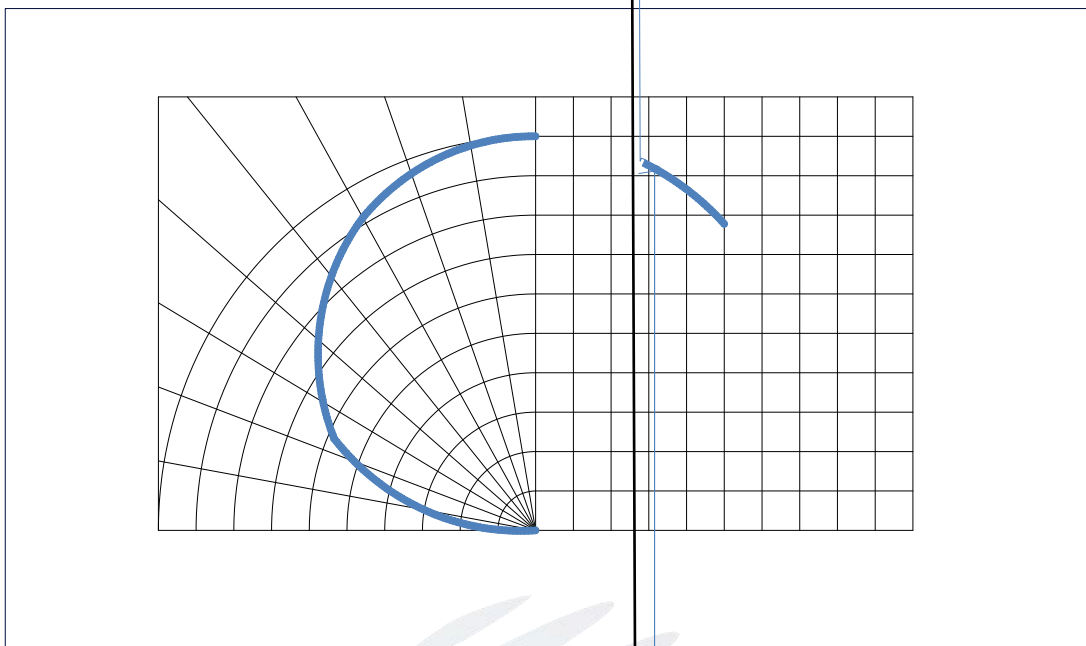

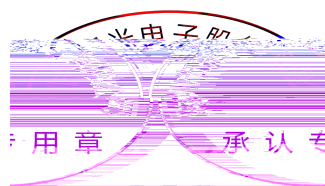
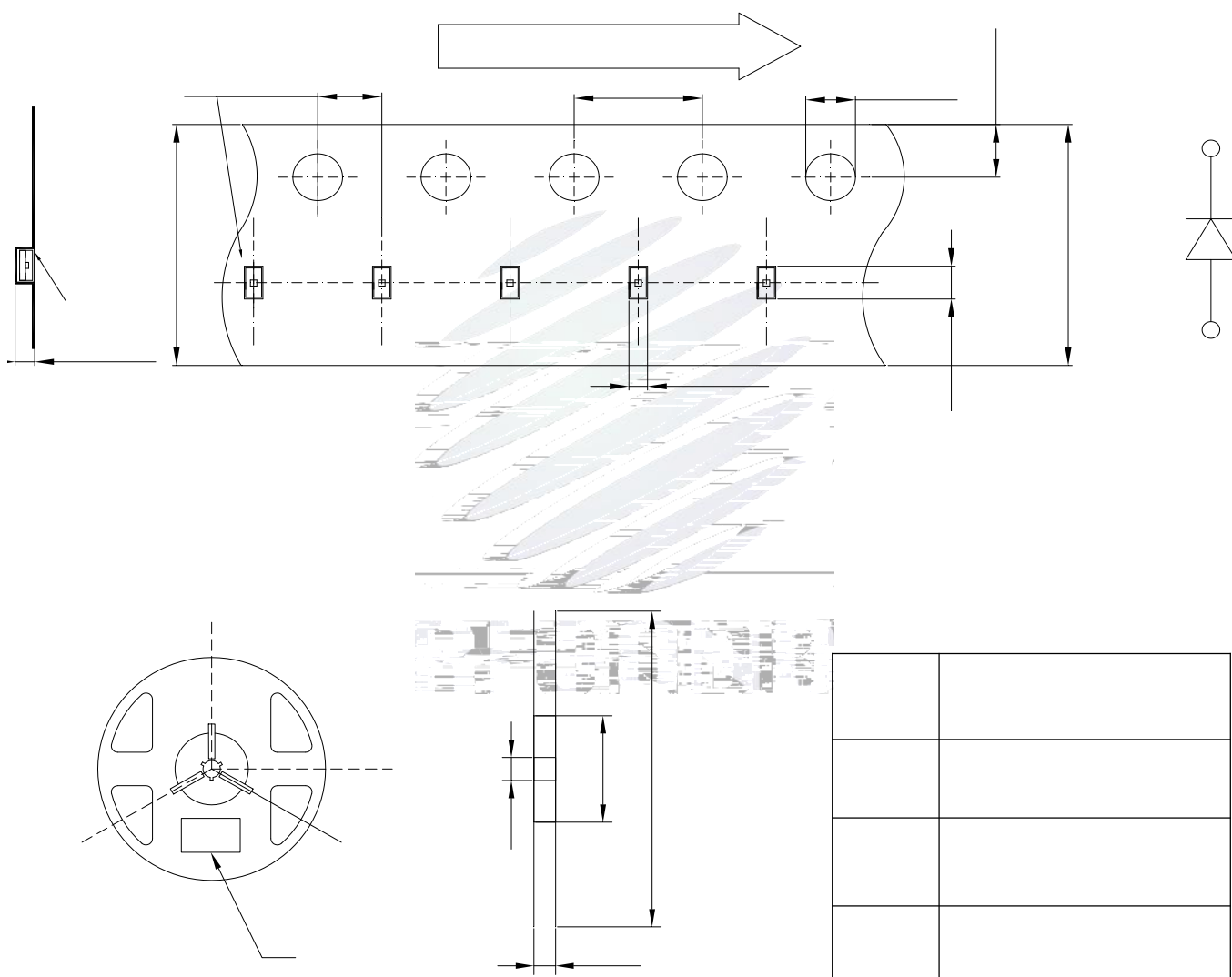

PART NO: .
 SPEC NO:
 LOT NO

BIN CODE:
 Φ: XY:
 VF: WLD:

QTY:
 DATE:

