

SPECIFICATION

REFOND P/N

RF-A1T28-W6SE-A6

R&D

Mass Production



Contents

- 1. Description
 - 1.1 General Description
 - 1.2 Features
 - 1.3 Application
 - 1.4 Package Dimension
 - 1.5 Product Parameters
 - 1.6 Bin Range Of Forward Voltage and Luminous Flux (IF=150mA) BIN
 - (IF=150mA)
 - 1.7 Typical Optical Characteristics Curves
- 2. Packaging
 - 2.1 Packaging Specification
 - 2.1.1 Carrier Tape Dimension 12
 - 2.1.2 Reel Dimension 12
 - 2.1.3 Label Form Specification 13
 - 2.2 Moisture Resistant Packing
 - 2.3 Cardboard Box
 - 2.4 Reliability Test Items And Conditions
 - 2.5 Criteria For Judging Damage
- 3. SMT Reflow Soldering Instructions SMT
 - 3.1 SMT Reflow Soldering Instructions SMT
- 4. Handling Precautions
 - 4.1 Handling Precautions



1. Description

1.1 General Description

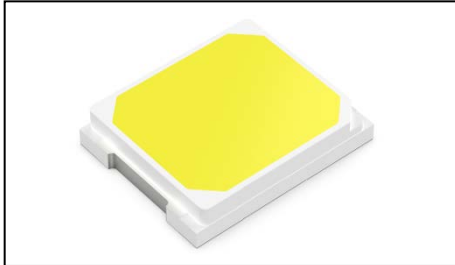

The white LED, which was fabricated by using a blue chip and the phosphor.

Product Package: 2.80mmX3.50mmX0.70mm.

LED

2.80mmX3.50mmX0.70mm.

1.2 Features

PLCC2 Package. PLCC2

Extremely wide viewing angle.

Suitable for all SMT assembly and solder process.

SMT

Available on tape and reel.

Moisture sensitivity level: Level 2.

Level2

Compliance with RoHS and REACH.

RoHS REACH

Qualifications: The product qualification test plan is based on the guidelines of AEC-Q101 Stress Test Qualification for Automotive Grade Discrete Semiconductors :

AEC-Q101

1.3 Application

Automotive Lighting Interior and Exterior.



1.4 Package Dimension

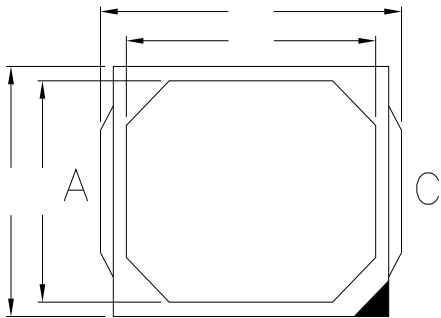

Fig.1-1 Top View

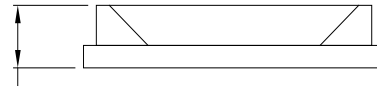

Fig.1-2 Side View

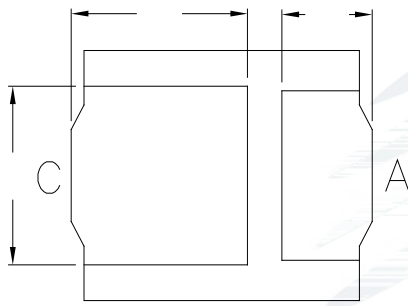

Fig.1-3 Bottom View

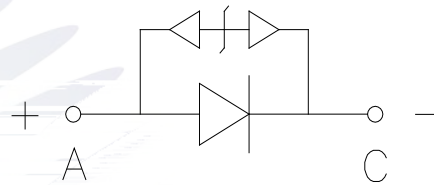

Fig.1-4 Polarity

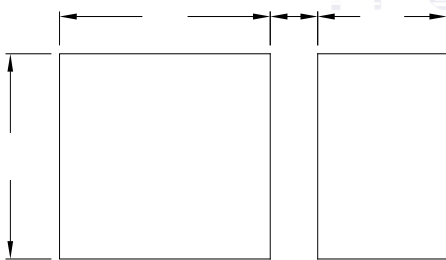

Fig.1-5 Soldering Patterns

Notes

1. All dimensions units are millimeters.
2. All dimensions tolerances are $\pm 0.2\text{mm}$ unless otherwise noted.



± 0.2

1.5 Product Parameters

Table 1-1 Electrical / Optical Characteristics at Ts=25°C

Item	Symbol	Test Condition	Value			Unit
			Min.	Typ.	Max.	
Forward Voltage	V_F	$I_F=150\text{mA}$	2.8	3.1	3.4	V
Reverse Current	I_R	$V_R=5\text{V}$	---	---	10	μA
Luminous Flux		$I_F=150\text{mA}$	55.3	65	75.3	lm
Viewing Angle		$I_F=150\text{mA}$	---	120	---	deg
Thermal Resistance.	R_{THJ-S}	$I_F=150\text{mA}$	---	---	21	$^{\circ}\text{C}/\text{W}$

Table 1-2 Absolute Maximum Ratings at Ts=25°C

Parameter	Symbol	Rating	Units
Power Dissipation	P_D	612	mW
Forward Current	I_F	180	mA
Peak Forward Current	I_{FP}	350	mA
Reverse Voltage	V_R	5	V
Electrostatic Discharge (HBM)	E_{SD}	8000	V
Operating Temperature	T_{OPR}	-40 ~ +110	
Storage Temperature	T_{STG}	-40 ~ +110	
Junction Temperature	T_J	125	

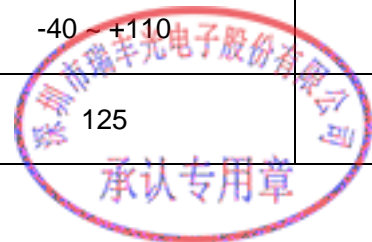

Notes

1. 1/10 Duty cycle, 10ms pulse width. 10ms, 1/10.
2. The above forward voltage measurement allowance tolerance is $\pm 0.1V$. $\pm 0.1V$.
3. The above color coordinates measurement allowance tolerance is ± 0.005 . ± 0.005 .
4. The above luminous intensity measurement allowance tolerance $\pm 10\%$. $\pm 10\%$.
5. Care is to be taken that power dissipation does not exceed the absolute maximum rating of the product.
6. All measurements were made under the standardized environment of Refond.
7. When the LEDs are in operation the maximum current should be decided after measuring the package temperature, junction temperature should not exceed the maximum rate. LED
8. ESD yield is over 90% at 8000V ESD (HBM). ESD protection during products handling is needed. 90% LED ESD8000V

1.6 Bin Range Of Forward Voltage and Luminous Flux (IF=150mA)

BIN (IF=150mA)

Table 1-3

V _F	G1	G2	H1	H2	I1	I2
	2.8-2.9	2.9-3.0	3.0-3.1	3.1-3.2	3.2-3.3	3.3-3.4
Im	PA	PB	QA			
	55.3-61.2	61.2-67.8	67.8-75.3			





1.7 Typical Optical Characteristics Curves

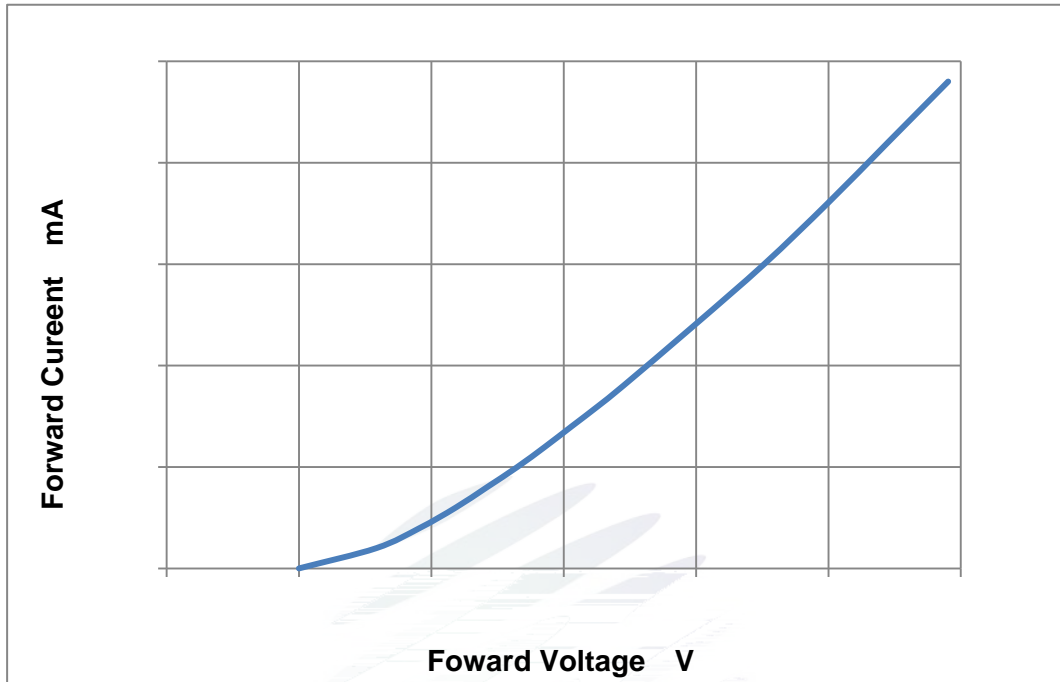

Fig. 1-7 Forward Voltage Vs Forward Current

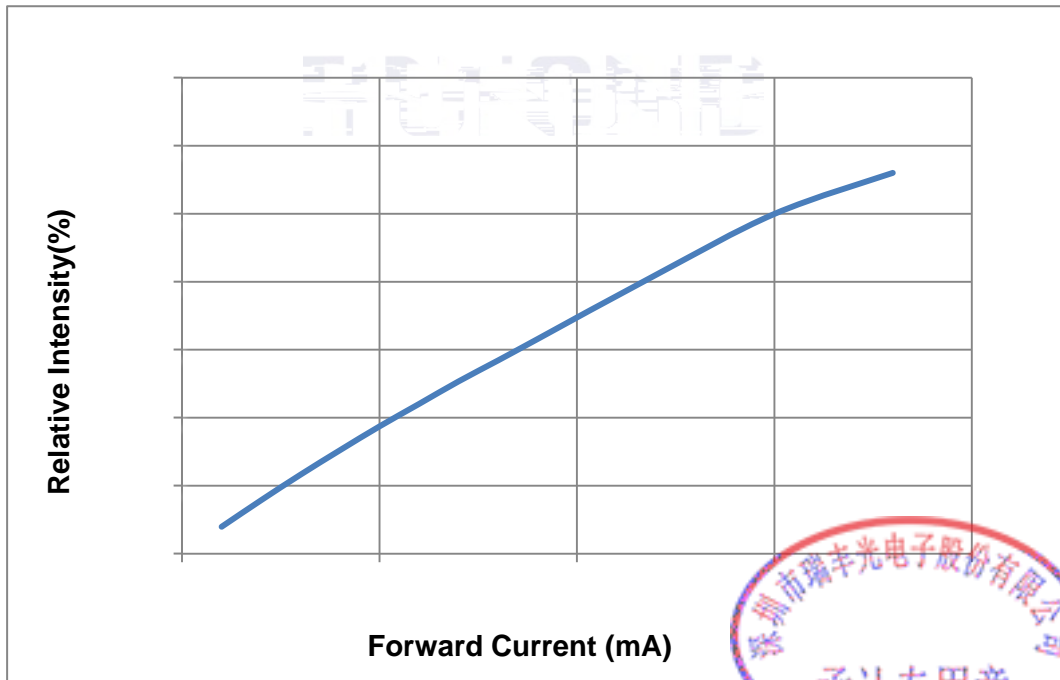

Fig. 1-8 Forward Current Vs Relative Intensity

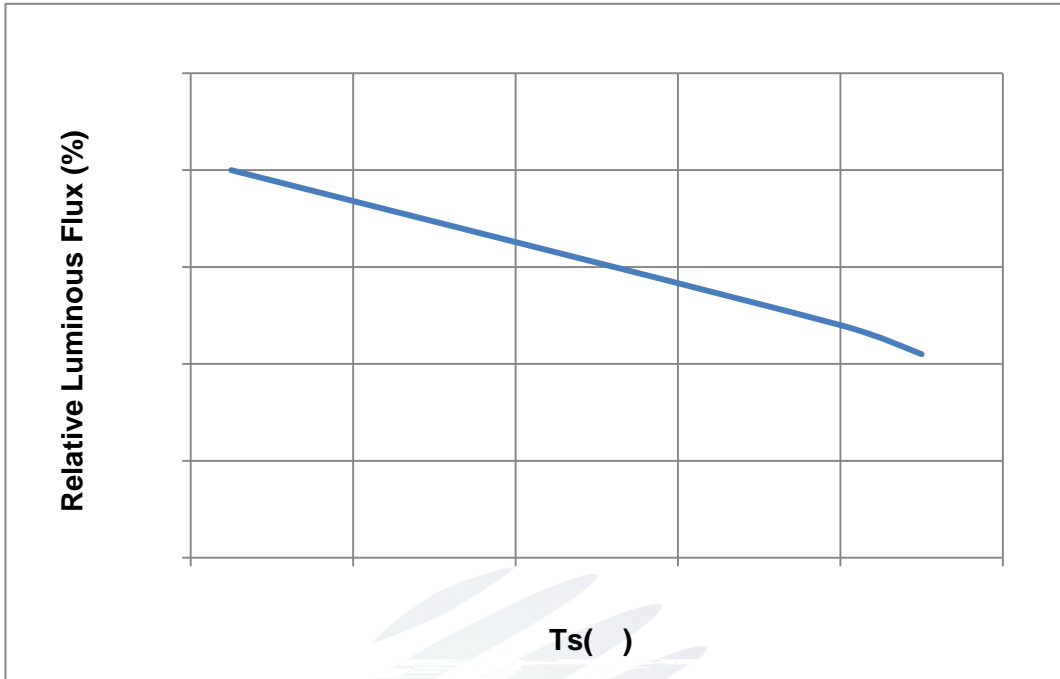

Fig. 1-9 Solder Temperature Vs Relative Intensity

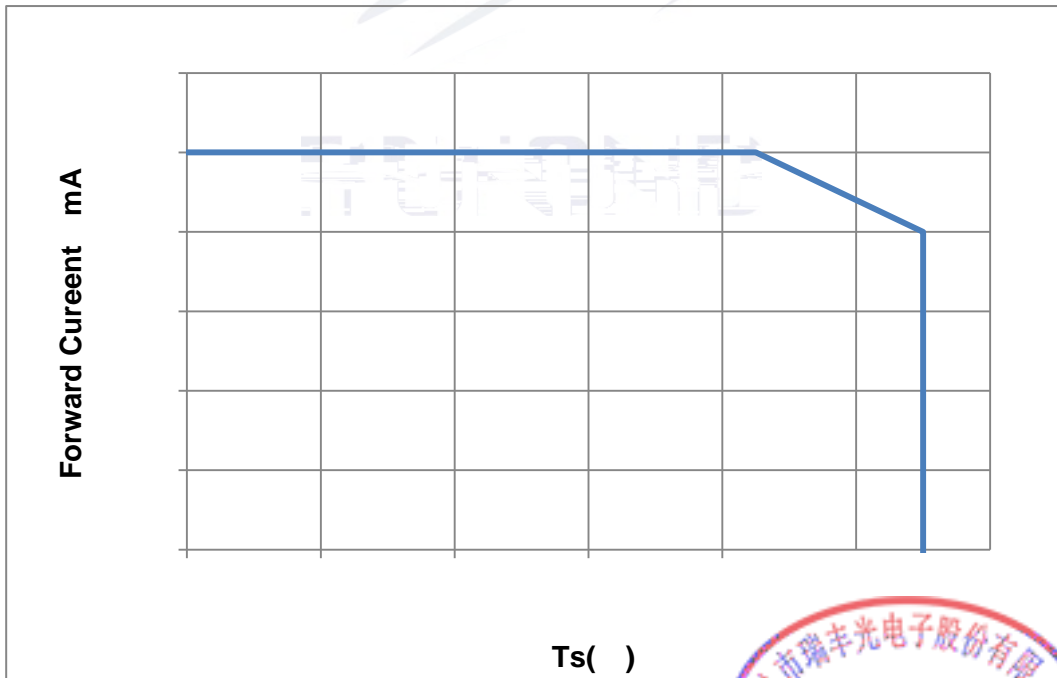

Fig. 1-10 Solder Temperature Vs Forward Current



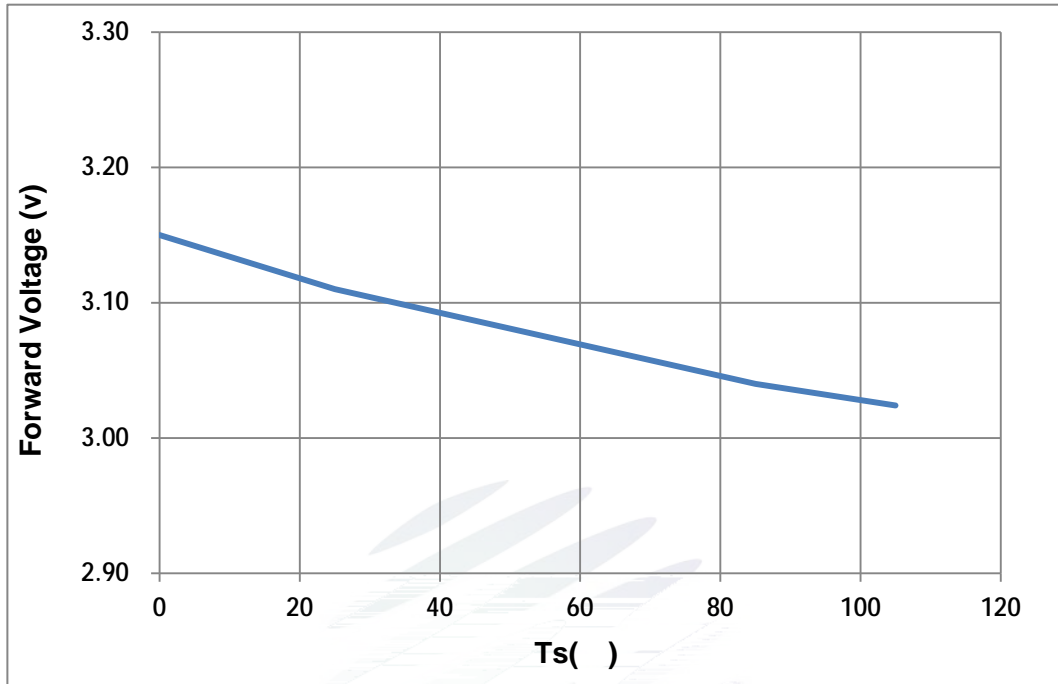

Fig. 1-11 Forward Voltage Vs Solder Temperature

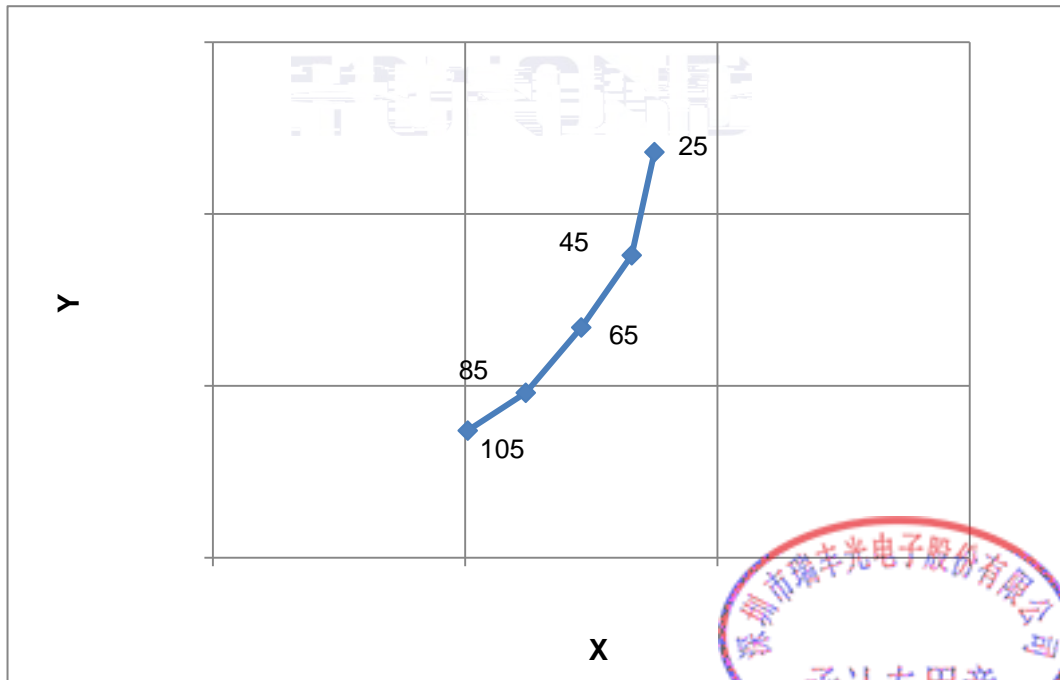
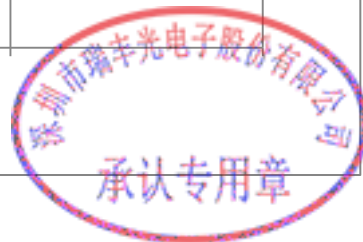

Fig. 1-12 Solder Temperature vs.



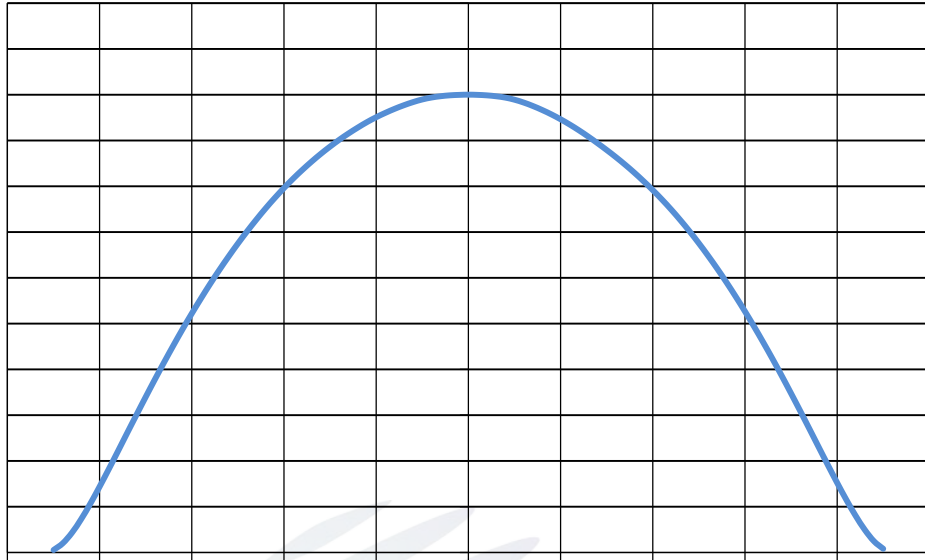

Fig. 1-13 Radiation diagram

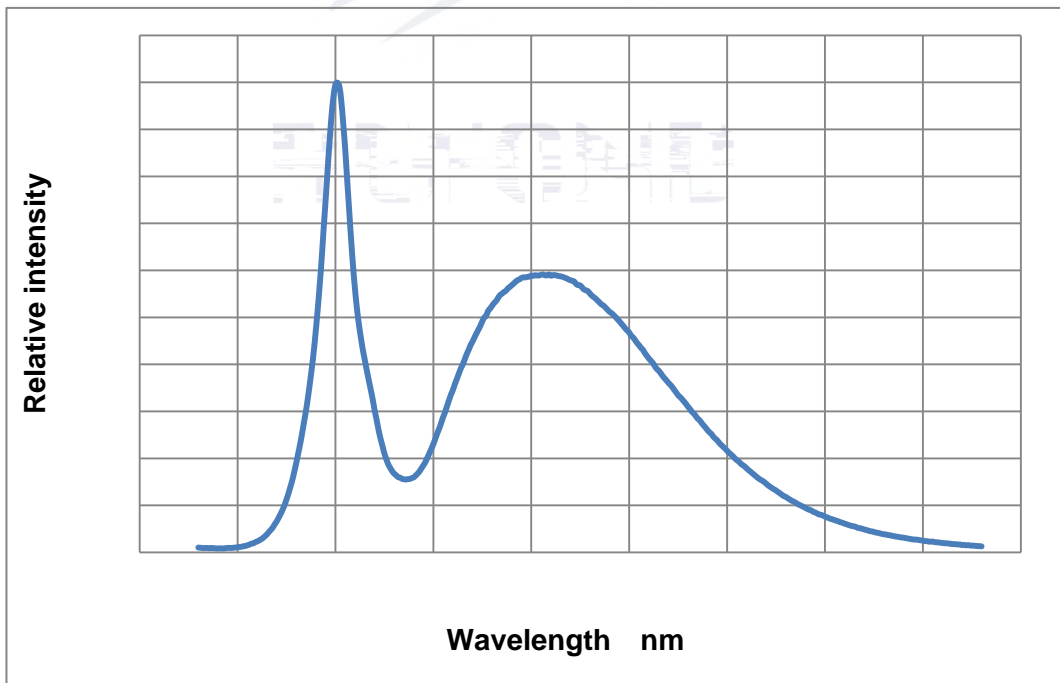

Fig. 1-14 Spectrum Distribution

2. Packaging

2.1 Packaging Specification

Package:4000pcs/reel.

2.1.1 Carrier Tape Dimension

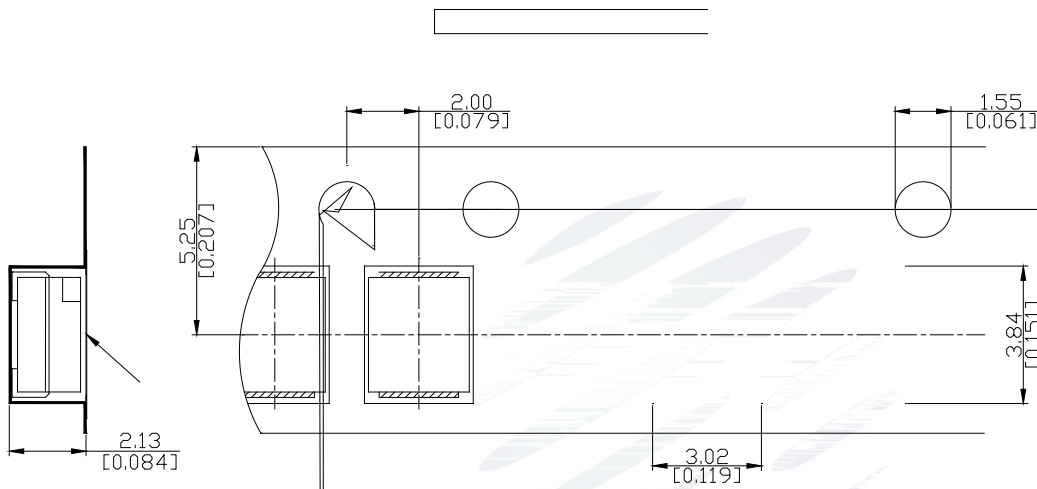

Fig.2-1 Carrier Tape Dimension

2.1.2 Reel Dimension

Table 2-1 Reel Dimension

Fig.2-2 Reel Dimension

Notes

The tolerances unless mentioned ± 0.1 mm. Unit : mm

± 0.1



2.1.3 Label Form Specification

Table 2-2 Specification

PART NO.	Part Number
SPEC NO.	Spec Number
LOT NO.	Lot Number
BIN CODE	Bin Code
	Luminous flux
XY	Chromaticity Bin
V _F	Forward Voltage
WLD	Wavelength
QTY	Packing Quantity
DATE	Made Date

Fig. 2-3 Label

2.2 Moisture Resistant Packing

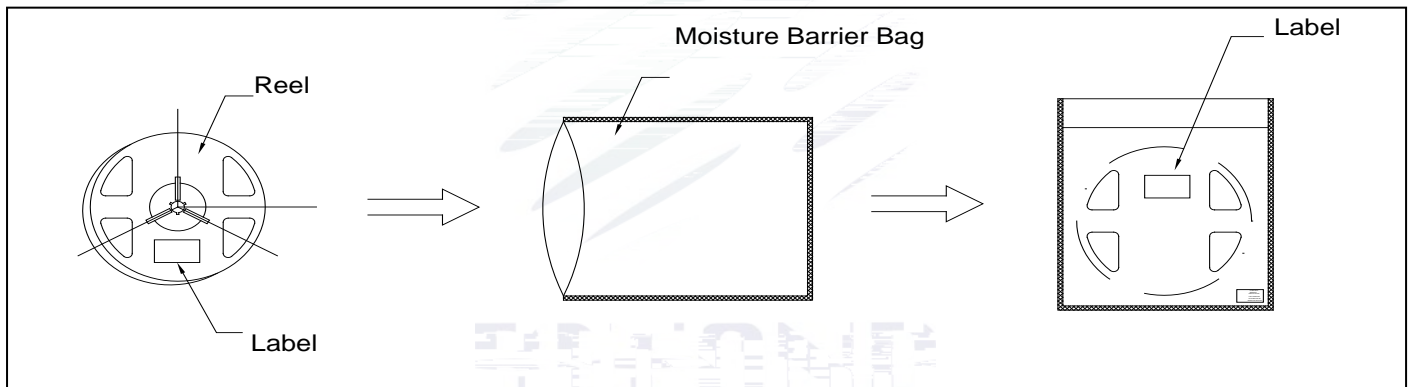

Fig.2-4 Moisture Resistant Packing

2.3 Cardboard Box

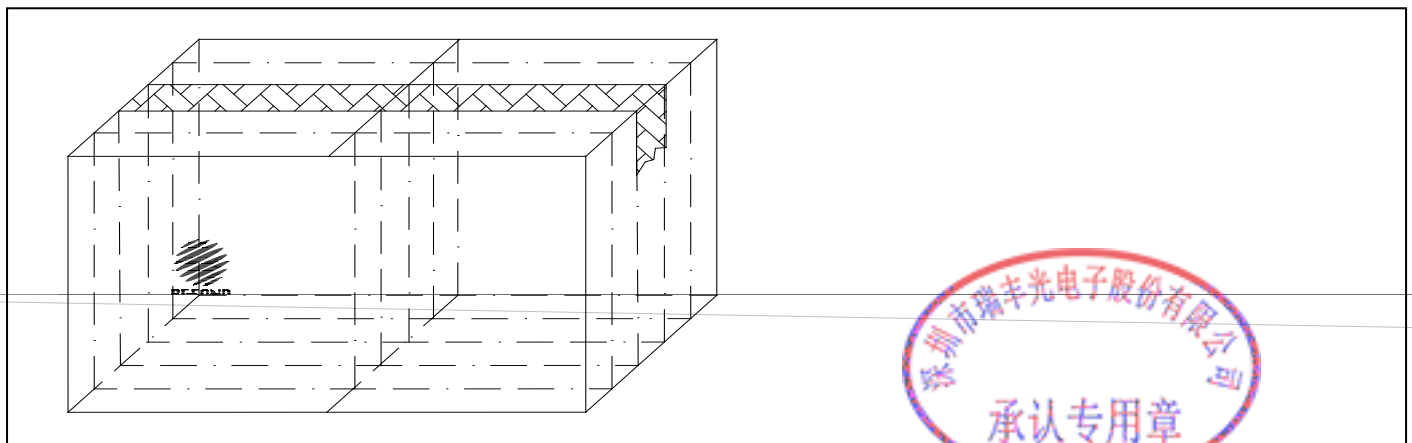

Fig.2- Cardboard Box

2.4 Reliability Test Items And Conditions

Table 2-3 Reliability Test Items And Conditions

Test Items	Ref.Standard	Test Condition	Time	Quantity	Ac/Re /
Reflow	JESD22-B106	Temp:260 max T=10 sec	2times	20pcs.	0/1
MSL2 2	JESD22-A113	85 / 60%RH	168 hrs.	20pcs.	0/1
Thermal Shock	JEITAED-4701 300307	-40 15min 125 15min	1000 cycle	20pcs.	0/1
Life Test	JESD22-A108	Ta=105 If=150mA	1000hrs.	20pcs.	0/1
High Temperature High Humidity Life Test	JESD22-A101	85 / 85%RH If=150mA	1000hrs.	20pcs.	0/1



2.5 Criteria For Judging Damage

Table 2-4 Criteria For Judging Damage

Test Items	Symbol	Test Condition	Criteria For Judgement	
			Min.	Max.
Forward Voltage	V_F	$I_F=150\text{mA}$	-	U.S.L*)x1.1
Reverse Current	I_R	$V_R = 5\text{V}$	-	U.S.L*)x2.0
Luminous Flux		$I_F=150\text{mA}$	L.S.L*)x0.7	-

Notes

- 1.U.S.L: Upper standard level L.S.L: Lower standard level
- 2.The above reliability tests is based on the verification of a single/strip LED of Refond's existing experimental platform,the reliability exp $T_w (22 0 T_d [(abo)-6(v)0.9(0.008(of)T_j] 0 T_c 0 T_w 05v)0.9(0.d1T_w 05v2 T_w)2.7777lit)-1(y)T$

3. SMT Reflow Soldering Instructions SMT

3.1 SMT Reflow Soldering Instructions SMT

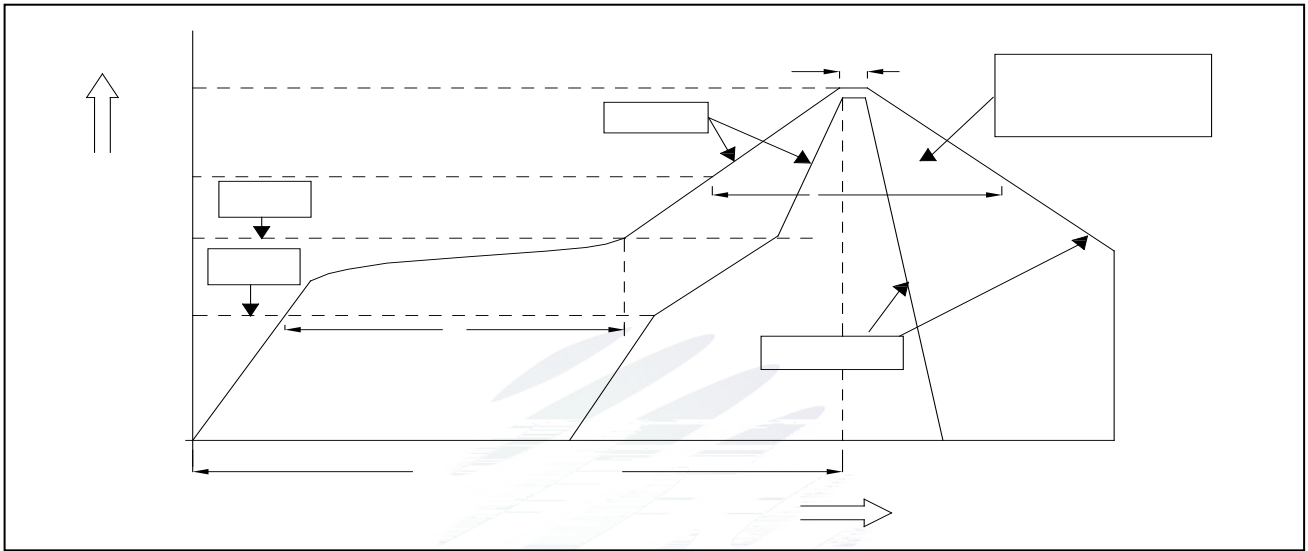
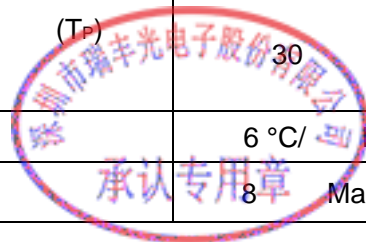

Fig.3-1 SMT Reflow Soldering Instructions SMT

Table 3-1 Reflow parameters

Average temperature rise speed	Tsmax	TP	3 °C/	Max 3 °C/ s
Preheating: minimum temperature	(Tsmmin)		150 °C	
Preheating: Max temperature	(Tsmmax)		200 °C	
Preheating: Time	Tsmmin	Tsmmax	60 - 120	60s-120s
Time limited to maintain high temperature: the temperature		(TL)	217 °C	
Time limited to maintain high temperature: The Time		(tl)	60	Max 60s
Peak /Classification of temperature:	/	(TP)	260 °C	
Time limit classification of peak temperature time		tp	10	Max 10s
Hold time within 5°C with the actual peak temperature (TP)		(TP)		Max 30s
Cooling speed			6 °C/	Max 6 °C/ s
Needed time from 25 °C to Tp	25°C		8	Max 8 minutes



Notes

(1)Reflow soldering should not be done more than twice. If more than 24 hours between the two solderings , LED will be damaged. 24 LED

(2)When soldering , do not put stress on the LEDs during heating.

3.1.1 Soldering Iron

(1) When do soldering by hand, keep the temperature of iron below less 300 less than 3 seconds , 300 3

(2) Soldering by hand should be done only one time.

3.1.2 Repairing

Repairing



4. Handling Precautions

4.1 Handling Precautions

(1) LED operating environment and sulfur element composition cannot be over 100PPM in the LED mating usage material. This is provided for informational purposes only and is not a warranty or endorsement.

LED 100PPM.

(2) In order to prevent ex-ternal material from getting into the inside of LED, which may cause the malfunction of LED, the single content of Bromine element is required to be less than 900PPM,the single content of Chlorine element is required to be less than 900PPM,the total content of Bromine element and Chlorine element in the external materials of the application products is required to be less than 1500PPM. This is provided for informational purposes only and is not a warranty or endorsement.

LED 900PPM LED 900PPM
1500PPM.

(3) VOCs (Volatile organic compounds) emitted from materials used in the construction of fixtures can penetrate silicone encapsulants of LEDs and discolor when exposed to heat and photonic energy. The result can be a significant loss of light output from the fixture. Knowledge of the properties of the materials selected to be used in the construction of fixtures can help prevent these issues. Refond advises against the use of any chemicals or materials that have been found or are suspected to have an adverse affect on device performance or reliability. To verify compatibility, Refond recommends that all chemicals and materials be tested in the specific application and environment for which they are intended to be used. Attaching LEDs, do not use adhesives that outgas organic vapor.

LED LED

LED

(4) Handle the component along the side surface by using forceps or appropriate tools; Do not directly touch or Handle the silicone lens surface, it may damage the internal circuitry.



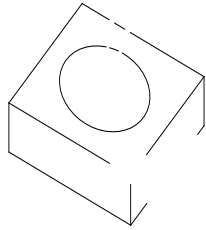

Fig 4-1 Handling Precautions

(5) In designing a circuit, the current through each LED can not exceed the absolute maximum rating specified for each LED. In the mean while, resistors for protection should be applied, other wise slight voltage shift will cause big current change, burn out may happen. The driving circuit must be designed to allow forward voltage only when it is ON or OFF. If the reverse voltage is applied to LED, migration can be generated resulting in LED damage.

LED

LED

(6) Thermal Design is paramount importance because heat generation may result in the Characteristics decline, such as brightness decreased, Color change and so on. Please consider the heat generation of the LEDs when making the system design.

LED

(7) Compared to standard encapsulants, silicone is generally softer, and the surface is more likely to attract dust, requiring special care during processing. In cases where a minimal level of dirt and dust particles cannot be guaranteed, a suitable cleaning solution must be applied to the surface after the soldering of components. Refond suggests using isopropyl alcohol for cleaning. In case other solvents are used, it must be assured that these solvents do not dissolve the package or resin. Ultrasonic cleaning is not recommended. Ultrasonic cleaning may cause damage to the LED.

LED



REFOND



Declare

This specification is written both in English and in Chinese and the latter is formal.