

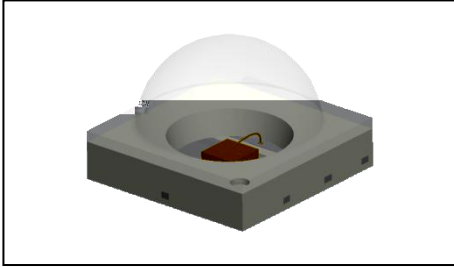

1.

1.1



1.2



1.

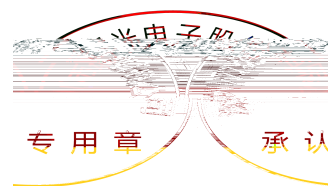

1.

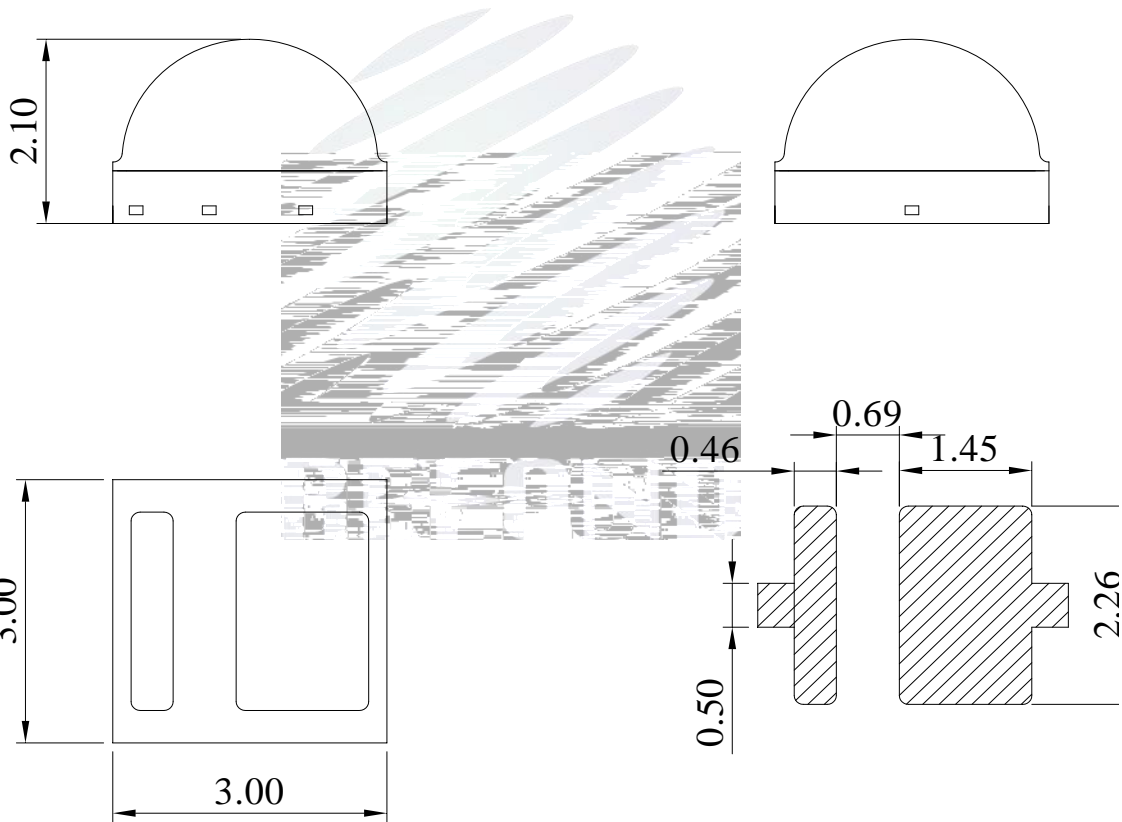
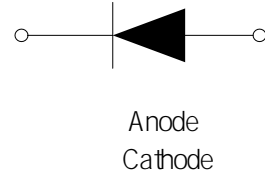
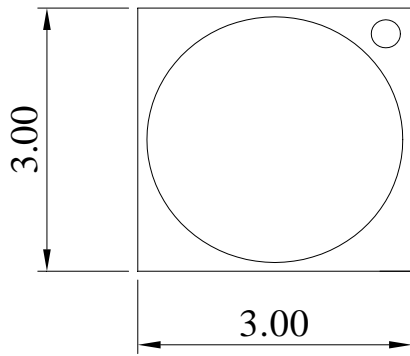

±

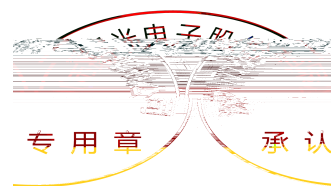

1.

	λ					

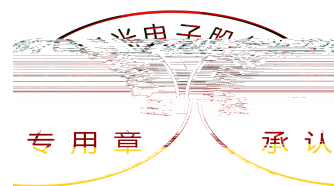

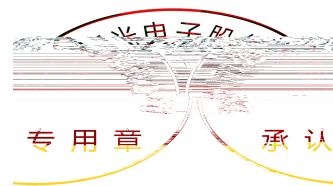
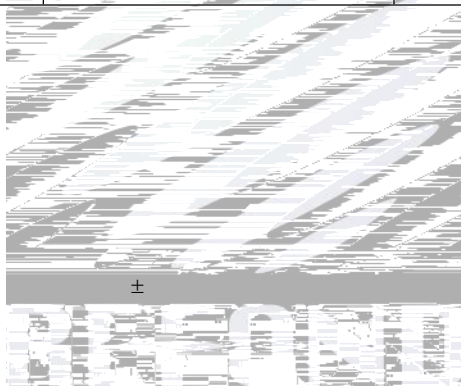

1.

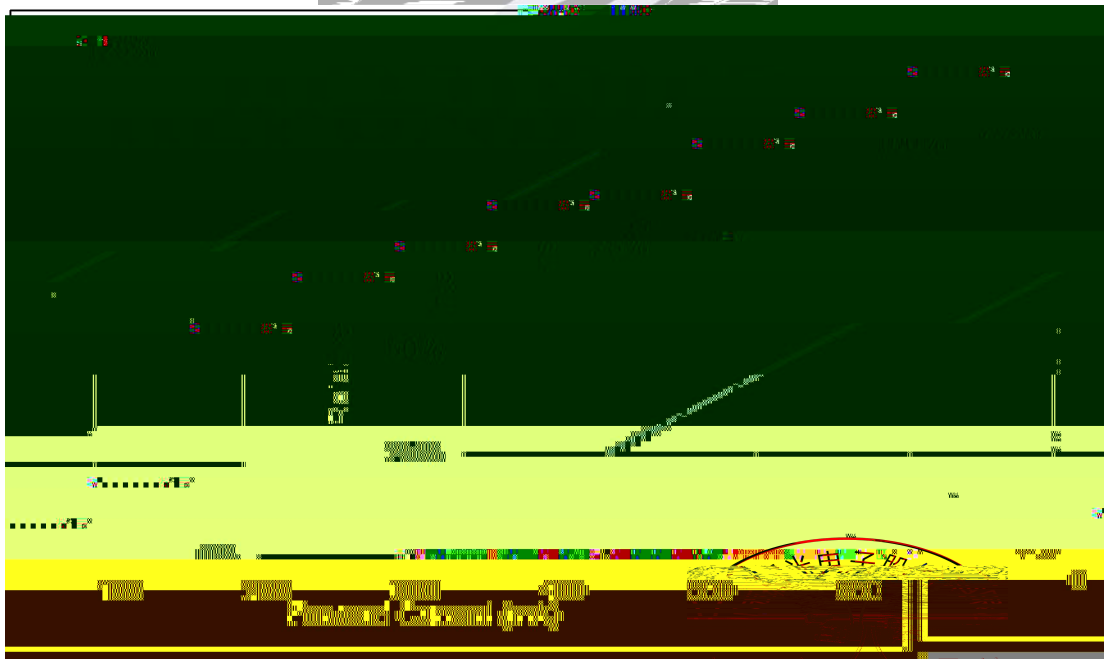
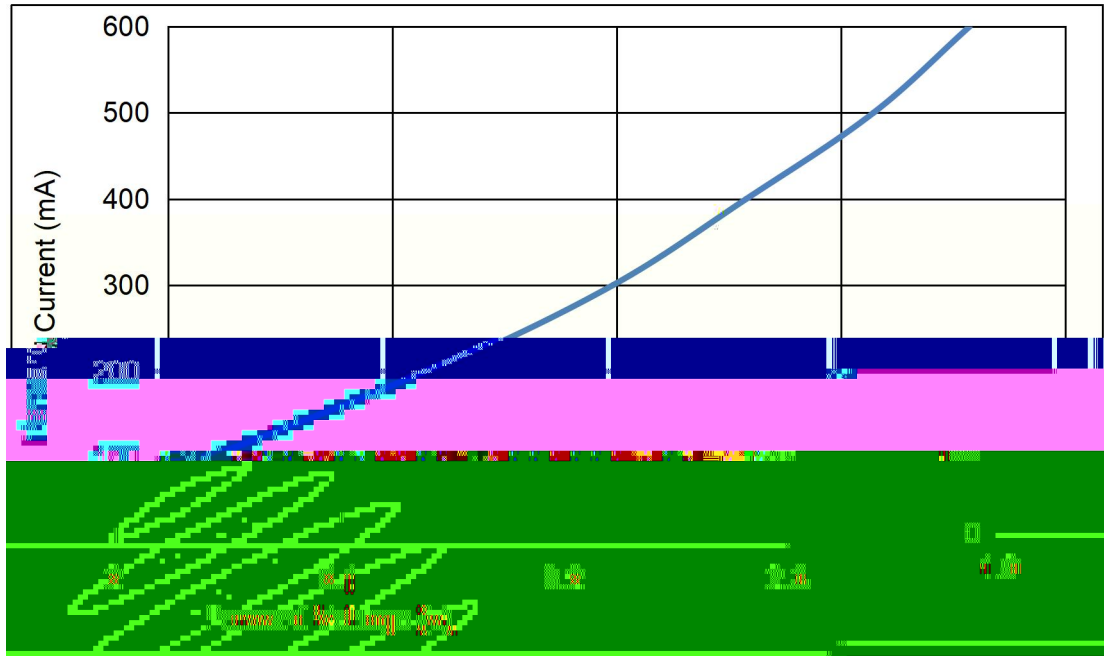

专用章 承认

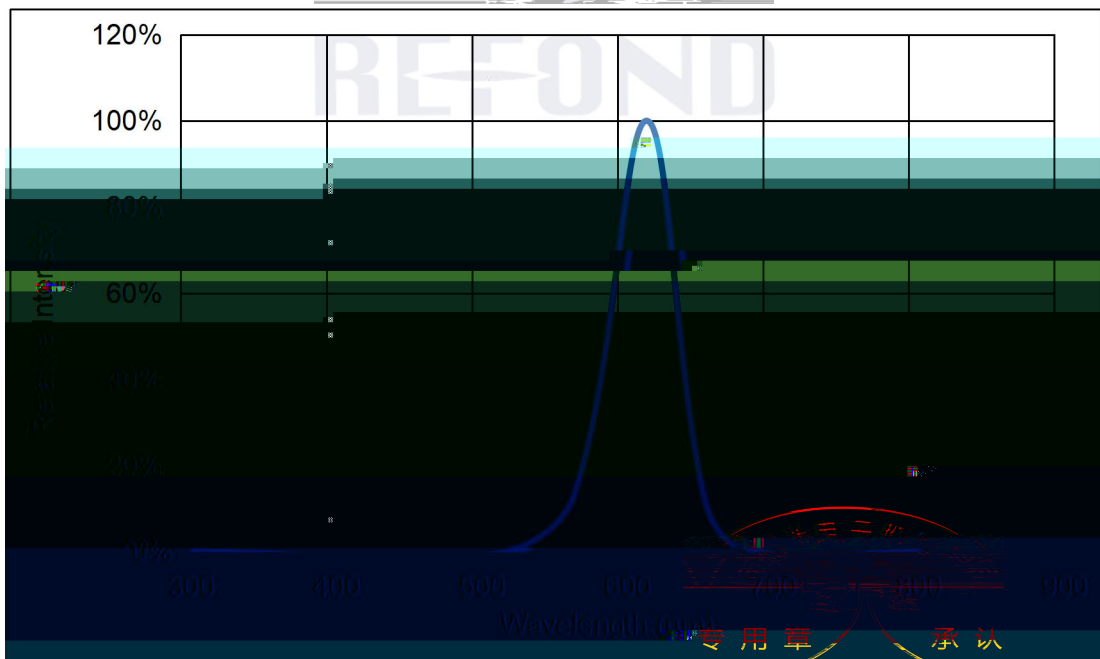
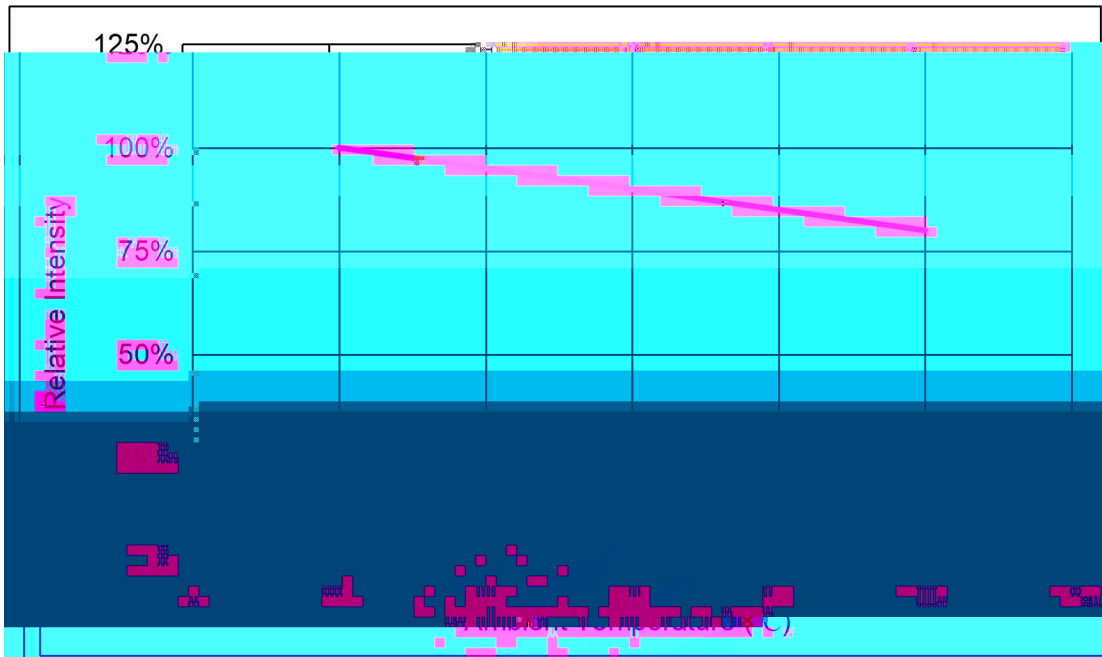

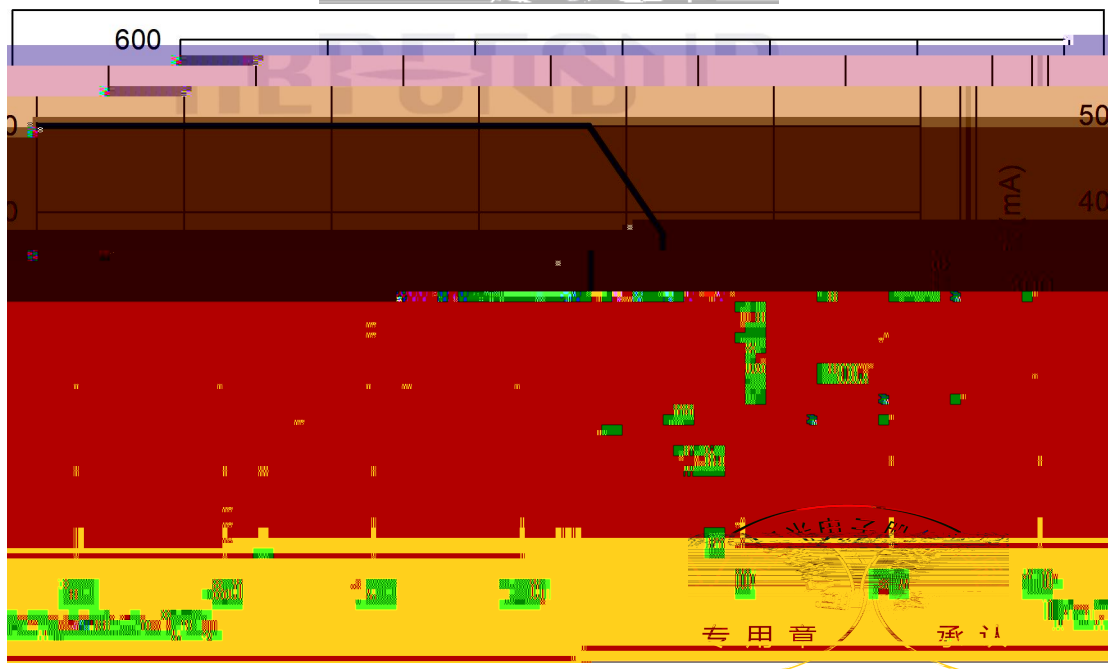
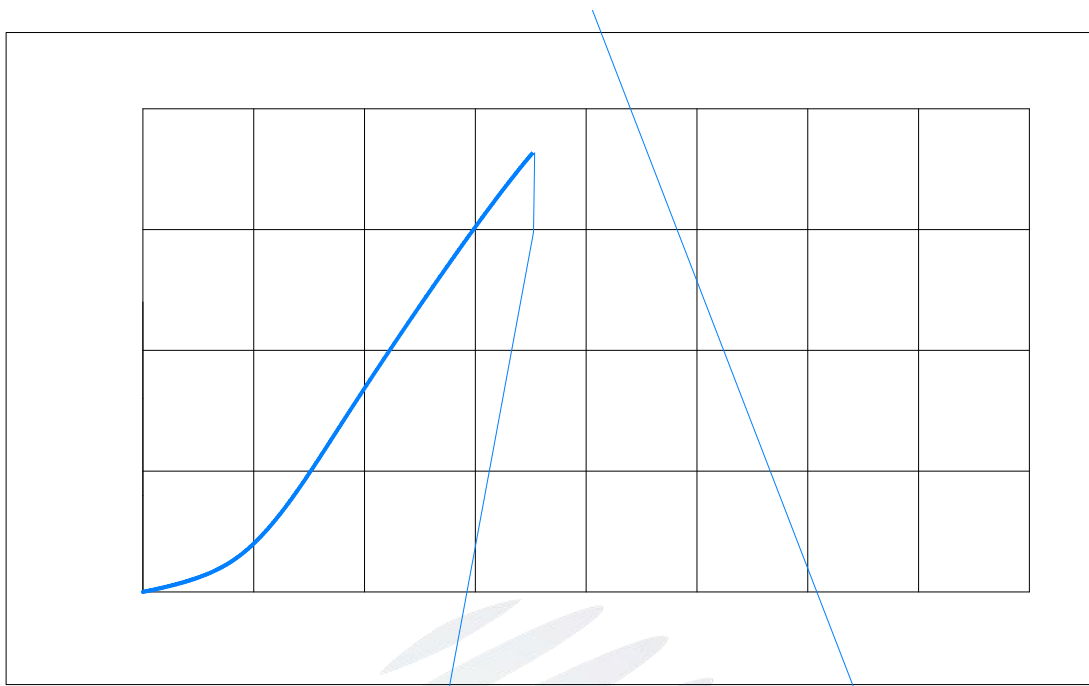

2.

2.1

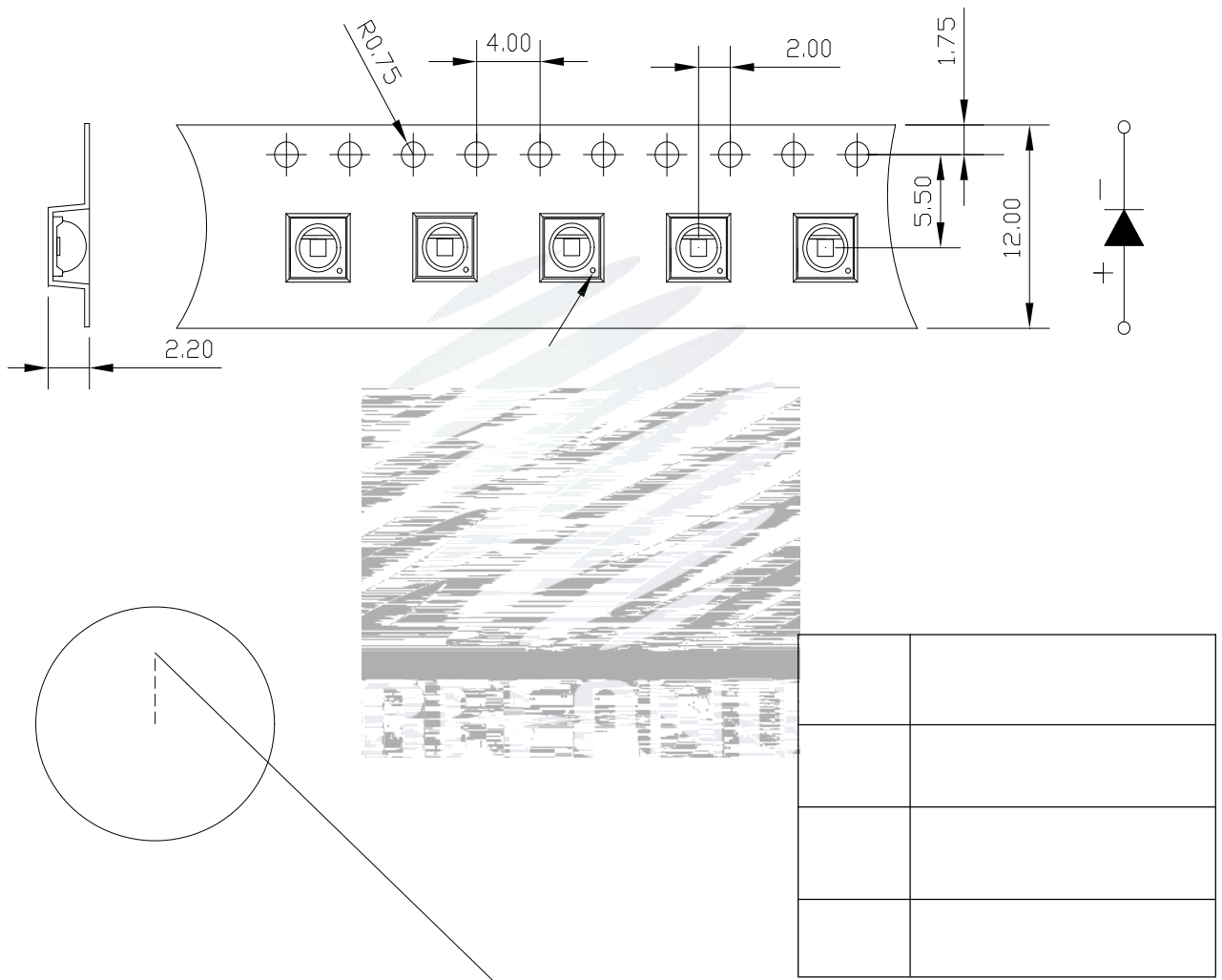



2.



2.

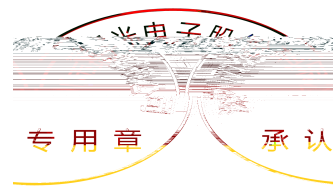

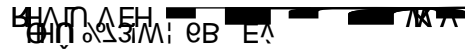
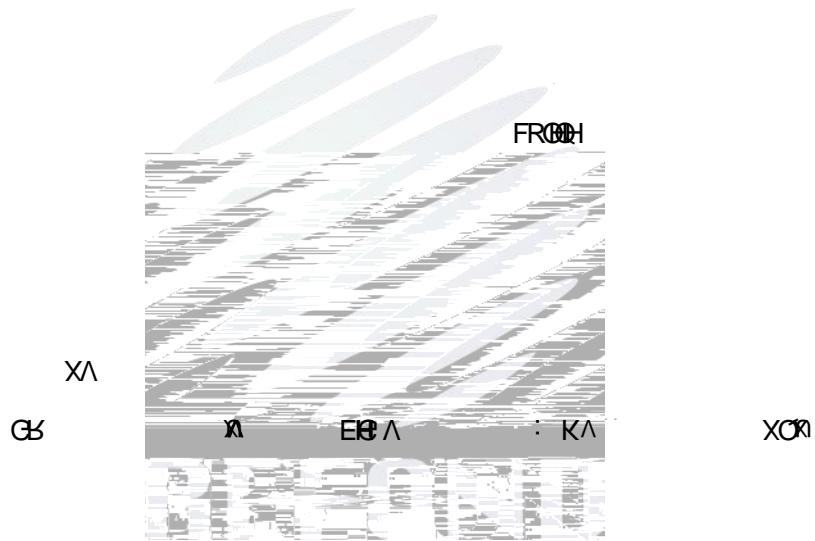
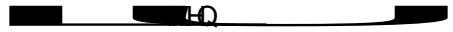

: KD



.1

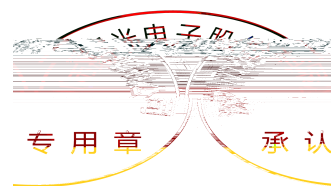

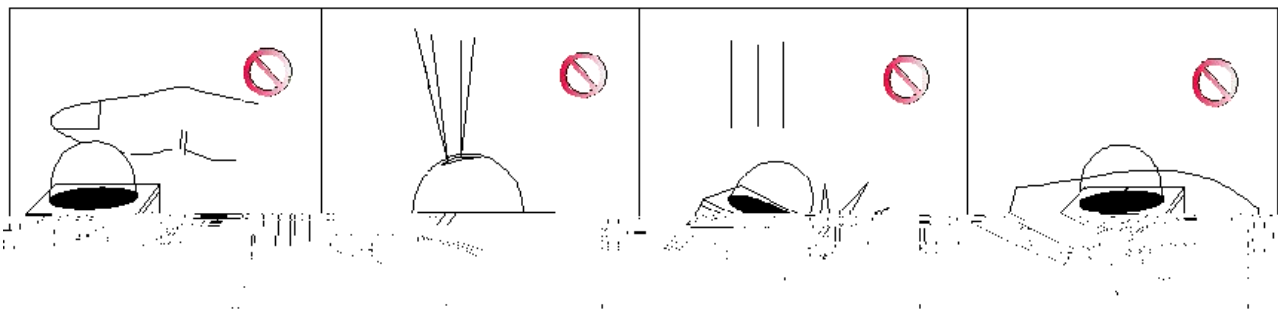



±

